

The Proton EDM

Alex Keshavarzi
University of Manchester

Joint APP, HEPP and NP
Conference, Liverpool, UK
8th April 2024

THE
ROYAL
SOCIETY

MANCHESTER
1824
The University of Manchester

The Strong CP problem

“The most underrated puzzle in all of physics.”

Forbes, 2019.

X @alexkeshavarzi

alexander.keshavarzi@manchester.ac.uk

Strong CP Problem

QCD (& The SM) has a glaring hole in it...

$$\mathcal{L}_{QCD} = (\dots) + \frac{g^2}{32\pi^2} \bar{\theta} \tilde{G}_{\mu\nu}^a G^{\mu\nu a}$$

P-violating
T-violating
CP-violating
Non-zero nucleon (N)
Electric Dipole Moment
(EDM) $\rightarrow |\vec{d}_N| = \vartheta(\theta)$.

BUT, no CP violation in strong interactions...

$[\bar{\theta} = \theta + \varphi = \text{QCD } \theta \text{-term} + \text{quark mass phase.}]$

\rightarrow No CP violation implies: $\bar{\theta} = \theta + \varphi = 0$ (Fine tuning!)

\rightarrow No EDM implies $|\bar{\theta}| \lesssim 10^{-10} \rightarrow |\vec{d}_N^{SM}| \lesssim 10^{-31} e \cdot cm$ (Fine tuning!)

The Strong CP problem is a whole community problem...

Non-zero proton EDM (pEDM), e.g. $10^{-25} e \cdot cm \gtrsim |\vec{d}_N| \gtrsim 10^{-30} e \cdot cm$:

- = Solves strong CP-problem!
- = CP-violation source for Baryon Asymmetry!
- = Unambiguous new physics (with no SM theory needed!).

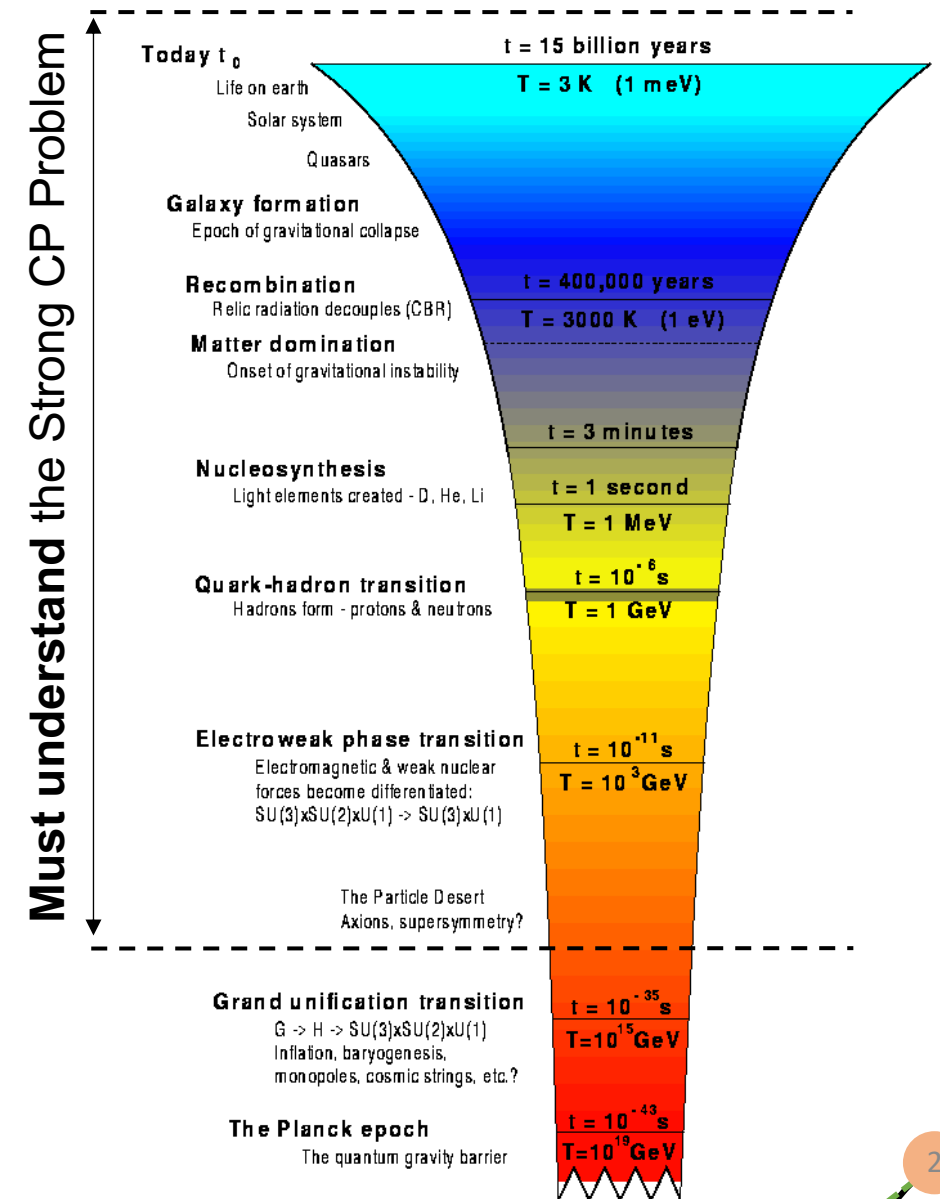

pEDM Experiment: New Physics Reach

Strong CP Problem	Matter-Antimatter Asymmetry	Dark Matter	EDM loop induced = wide range of interactions/energy scales $d_p \sim (g^2 / 16\pi^2) (e m_q) / \Lambda_{NP}^2 \sin \phi^{NP} e \cdot cm$ <small>m_q = mass of 1-loop quark, ϕ^{NP} = complex CP violation phase of NP</small>	
Solved!	Model-independent CP-violation.	Oscillating pEDM signature = axion [not in nEDM!]. <small>ERJC 84 (2024) 12, arXiv:2308.16135, PRD 99 (2019) 083002, PRD 104 (2021) 096006</small>	Light, weak new physics: $\Lambda_{NP} \sim 1 \text{ GeV}$, $g \lesssim 10^{-5}$, $\phi^{NP} \sim 10^{-10}$. [e.g. LZ, LDMX, FASER, SHiP.]	$\mathcal{O}(\text{PeV})$ mass scale: $\phi^{NP} \sim 1$, $\Lambda_{NP} \sim 3 \times 10^3 \text{ TeV}$. [e.g. LHC/FCC.]

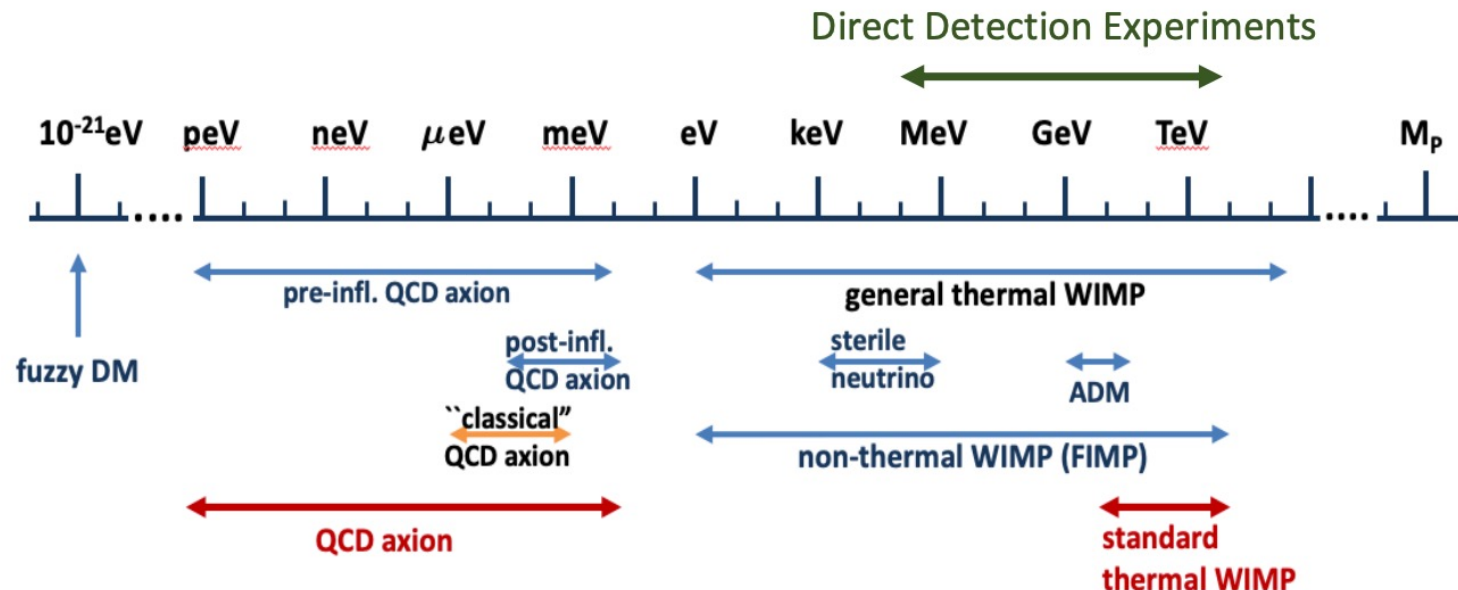

pEDM Experiment: a Muon g-2 spin-off

Consider Muon g-2 experiment: charged particle in magnetic (\vec{B}) and electric (\vec{E}) fields:

$$\vec{\omega}_{spin} = \vec{\omega}_{MDM} \approx \frac{e}{m} \left[a\vec{B} + \left(a - \frac{1}{\gamma^2 - 1} \right) (\vec{\beta} \times \vec{E}) \right].$$

pEDM Experiment: a Muon g-2 spin-off

Consider Muon g-2 experiment: charged particle in magnetic (\vec{B}) and electric (\vec{E}) fields:

$$\vec{\omega}_{spin} = \vec{\omega}_{MDM} \approx \frac{e}{m} \left[a\vec{B} + \left(a - \frac{1}{\gamma^2 - 1} \right) (\vec{B} \times \vec{E}) \right].$$

Muon \rightarrow storage ring magnet $R_0 = 7.112$ m and $B = 1.45$ T ...

Choose muon g-2 magic-momentum, $\gamma_{magic} = \sqrt{1 + 1/a} \rightarrow p = 3.094$ GeV/c.

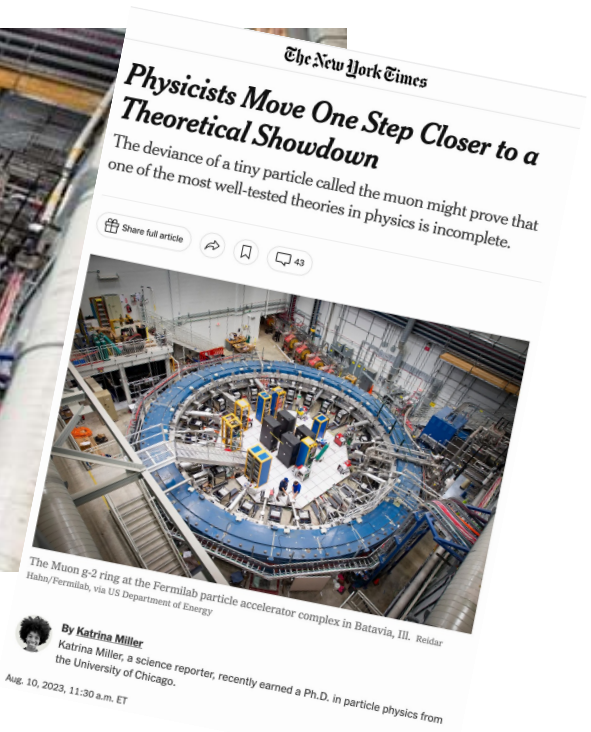
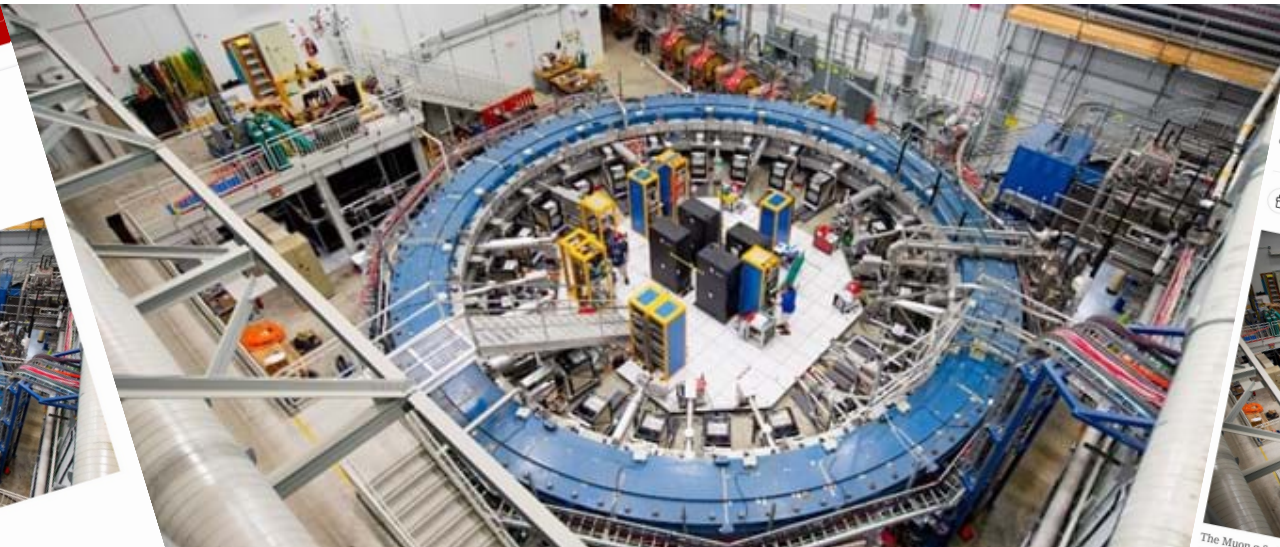

Major experimental and particle physics success!
Currently 200ppb precision!

pEDM Experiment: a Muon g-2 spin-off

Use Muon g-2 principles: charged particle with EDM in magnetic (\vec{B}) and electric (\vec{E}) fields:

$$\vec{\omega}_{spin} = \vec{\omega}_{MDM} + \vec{\omega}_{EDM} \approx \frac{e}{m} \left[a\vec{B} + \left(a - \frac{1}{\gamma^2 - 1} \right) (\vec{\beta} \times \vec{E}) + \frac{\eta}{2} \left(\frac{\vec{E}}{c} + \vec{\beta} \times \vec{B} \right) \right], \quad \vec{d} = \eta \frac{q\hbar}{2mc} \vec{S}.$$

pEDM Experiment: a Muon g-2 spin-off

Use Muon g-2 principles: charged particle with EDM in magnetic (\vec{B}) and electric (\vec{E}) fields:

$$\vec{\omega}_{spin} = \cancel{\vec{\omega}_{MDM}} + \vec{\omega}_{EDM} \approx \frac{e}{m} \left[a\vec{B} + \left(a - \frac{1}{\gamma^2 - 1} \right) (\vec{\beta} \times \vec{E}) + \frac{\eta}{2} \left(\frac{\vec{E}}{c} + \vec{\beta} \times \vec{B} \right) \right], \quad \vec{d} = \eta \frac{q\hbar}{2mc} \vec{S}.$$

Proton \rightarrow electric storage ring $R_0 = 800$ m and $E = 4.4$ M/m ...

Choose pEDM magic-momentum: $a\vec{B} + \left(a - \frac{1}{\gamma^2 - 1} \right) (\vec{\beta} \times \vec{E}) = 0 \rightarrow p = 0.7$ GeV/c.

Frozen-spin technique!

pEDM Experiment: a Muon g-2 spin-off

Use Muon g-2 principles: charged particle with EDM in magnetic (\vec{B}) and electric (\vec{E}) fields:

$$\vec{\omega}_{spin} = \cancel{\vec{\omega}_{MDM}} + \vec{\omega}_{EDM} \approx \frac{e}{m} \left[\cancel{a\vec{B} + \left(a - \frac{1}{\gamma^2 - 1}\right) (\vec{\beta} \times \vec{E})} + \frac{\eta}{2} \left(\frac{\vec{E}}{c} + \vec{\beta} \times \vec{B} \right) \right], \quad \vec{d} = \eta \frac{q\hbar}{2mc} \vec{S}.$$

Proton \rightarrow electric storage ring $R_0 = 800$ m and $E = 4.4$ M/m ...

Choose pEDM magic-momentum: $a\vec{B} + \left(a - \frac{1}{\gamma^2 - 1}\right) (\vec{\beta} \times \vec{E}) = 0 \rightarrow p = 0.7$ GeV/c.

Frozen-spin technique!

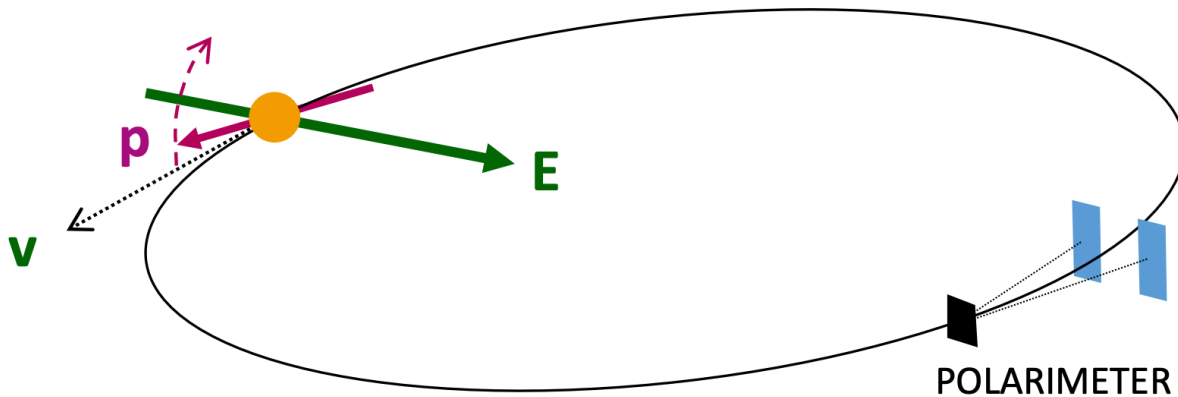

- Inject $\mathcal{O}(10^{10})$ polarized protons every twenty minutes.
- \vec{E} -field bending and \vec{B} -field focusing.
- Vertical polarization in polarimeter = static EDM.

And no SM calculation to compare to!

What about large, T-conserving systematics that mimic vertical, T-violating EDM, e.g. radial \vec{B} field?

pEDM Experiment: a Muon g-2 spin-off

Use Muon g-2 principles: charged particle with EDM in magnetic (\vec{B}) and electric (\vec{E}) fields:

$$\vec{\omega}_{spin} = \cancel{\vec{\omega}_{MDM}} + \vec{\omega}_{EDM} \approx \frac{e}{m} \left[a\vec{B} + \left(a - \frac{1}{\gamma^2 - 1} \right) (\vec{\beta} \times \vec{E}) + \frac{\eta}{2} \left(\frac{\vec{E}}{c} + \vec{\beta} \times \vec{B} \right) \right], \quad \vec{d} = \eta \frac{q\hbar}{2mc} \vec{S}.$$

Proton \rightarrow electric storage ring $R_0 = 800$ m and $E = 4.4$ M/m ...

Choose pEDM magic-momentum: $a\vec{B} + \left(a - \frac{1}{\gamma^2 - 1} \right) (\vec{\beta} \times \vec{E}) = 0 \rightarrow p = 0.7$ GeV/c.

Frozen-spin technique!

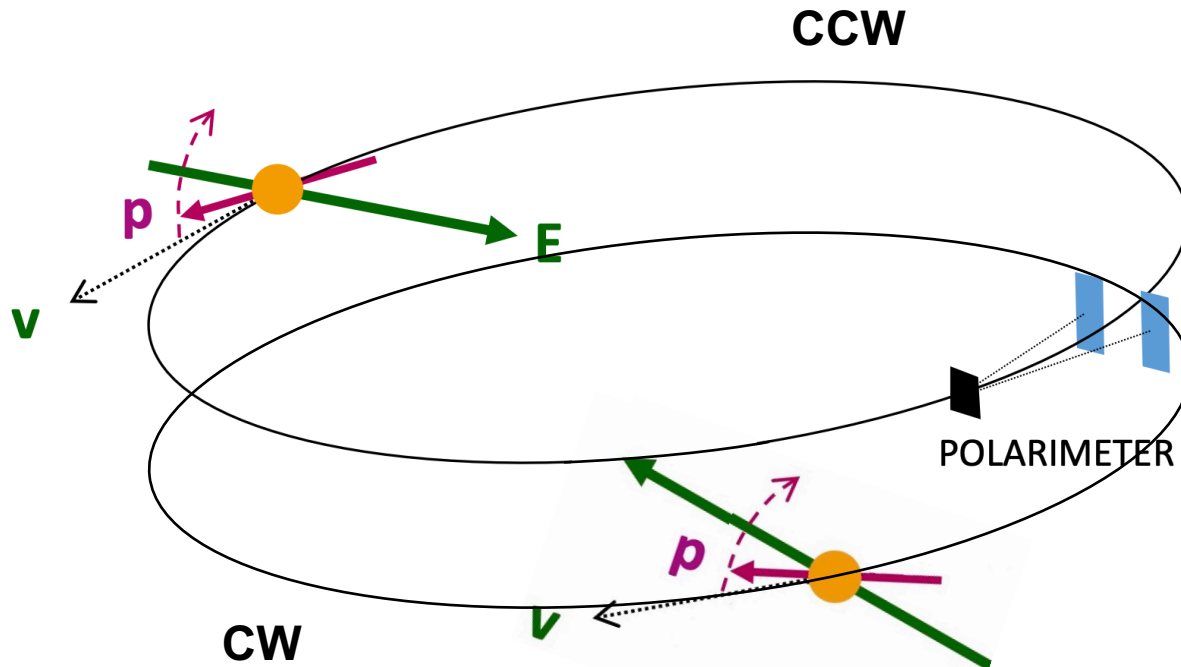

- Inject $\mathcal{O}(10^{10})$ polarized protons every twenty minutes.
- \vec{E} -field bending and \vec{B} -field focusing.
- Vertical polarization in polarimeter = static EDM.

And no SM calculation to compare to!

What about large, T-conserving systematics that mimic vertical, T-violating EDM, e.g. radial \vec{B} field?

\rightarrow Store CW and CCW beams (time reverse of each other) to cancel these effects!

pEDM Experiment: funding and timeline

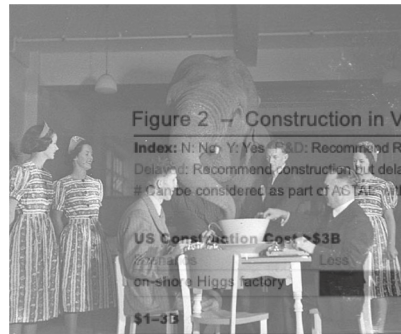

Recent P5 report was not good for proton EDM at BNL

Figure 2 - Construction in Various Budget Scenarios

Index: N: No, Y: Yes, R&D: Recommended R&D but no funding for project, C: Conditional yes based on review, P: Primary, S: Secondary
Delayed: Recommended, construction but delayed to the next decade
Change considered as part of AG (AG with reduced scope)

	Baseline	More	Neutrinos	Higgs Boson	Dark Matter	Cosmic Evolution	Direct Evidence	Quantum Imprints	Astronomy & Astrophysics
US Construction Cost \$3B	N	N		P	S		P	P	
off-shore Higgs factory	Delayed	Y	Y	P	S		P	P	
ACE-BR	R&D	R&D	C	P			P	P	
\$400-1000M									
CMB-S4	Y	Y	Y	S	S	P			P
Spec-S5	R&D	R&D	Y	S	S	P			P
\$100-400M									
IceCube-Gen2	Y	Y	Y	P	S				P
G3 Dark Matter 1	Y	Y	Y	S	P				
DUNE FD3	Y	Y	Y	P			S	S	S
test facilities & demonstrator	C	C	C		P	P	P	P	
ACE-MIRT	R&D	Y	Y	P					
DUNE FD4	R&D	R&D	Y	P			S	S	S
G3 Dark Matter 2	N	N	Y	S	P				
Mu2e-II	R&D	R&D	R&D						P
srEDM	N	N	N				S?	S?	P
\$60-100M									
SURF Expansion	N	Y	Y	P	P				
DUNE MCND	N	Y	Y	P			S	S	
MATHUSLA #	N	N	N		P		P		
FPF #	N	N	N	P	P		P		

Report of the 2023 Particle Physics Project Prioritization Panel

Muon Collider Forum Report, arXiv:2209.01318 (2022).

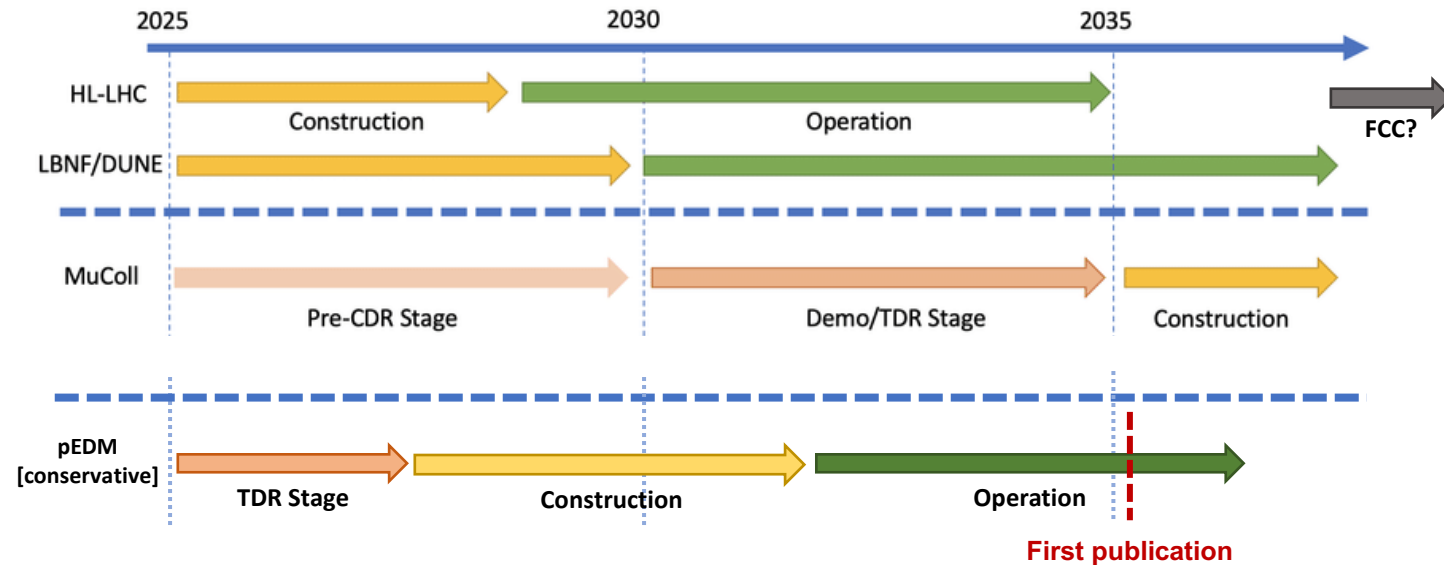

- U.S. labour costs – cost engineering underway.
 - Realistic savings already identified!
- May be substantially cheaper if constructed in UK/Europe!
 - e.g 2-3x cheaper if UK delivers ready-to-install system.

- From TDR to final publication in < 20 years.
- Can be started and finished by the new generation.
- Paramount physics drivers:
 - Solve strong CP problem.
 - Baryon asymmetry.
 - Dark matter.

Arguably one of the most low-cost/high-return proposals in particle physics today!

pEDM potential locations

BNL



- R&D and planning done for 800m ring at AGS:
 - Well-understood polarised proton delivery.
 - Viable site with thought-out ring.
 - Ground stability already understood.
- Genesis of current g-2 team and expertise.
- Construction/engineering can be done in UK/EU.
- Least work to realisation but restricted by funding issues.

COSY



- Home of pEDM precursor experiment.
- R&D/testing ongoing at COSY (e.g. polarimeters).
- But $\mathcal{O}(10^2)$ less polarised proton intensity c.f. BNL.
- End of COSY operations after 2024 (??).

CERN



- CERN is our national PP lab.
- Could make use of old ISR (CW/CCW beams).
- Could do polarised protons (or BNL polarisers).
- Cheaper than U.S. (but 950m ring = more expensive).
- Not tied to P5 report.
- More work to be done compared to BNL.
- Approved/balanced against CERN/LHC/FCC programme.

pEDM potential locations

BNL



- R&D and planning done for 800m ring at AGS:
 - Well-understood polarised proton delivery.
 - Viable site with thought-out ring.
 - Ground stability already understood.
- Genesis of current g-2 team and expertise.
- Construction/engineering can be done in UK/EU.
- Least work to realisation but restricted by funding issues.

COSY



- Home of pEDM precursor experiment.
- R&D/ testing ongoing at COSY (e.g. polarimeters).
- But $\mathcal{O}(10^2)$ less polarised proton intensity c.f. BNL.
- End of COSY operations after 2024 (??).

CERN



- CERN is our national PP lab.
- Could make use of old ISR (CW/CCW beams).
- Could do polarised protons (or BNL polarisers).
- Cheaper than U.S. (but 950m ring = more expensive).
- Not tied to P5 report.
- More work to be done compared to BNL.
- Approved/balanced against CERN/LHC/FCC programme.

UK ???



- Ambition to have a UK-based experiment.
- Benefits to having a national facility (e.g. Boulby).
- Could borrow/use BNL polarised proton technology.
- House it at e.g. Daresbury. Ring minimum 450m.
- Use UK engineering/experience (e.g. Cockcroft/JAI).
- Ring/polarimeter engineering and construction in UK.
- Substantial g-2/EDM expertise.

(Short) path to readiness

Main message: no showstoppers! Due diligence, physics case studies, moving to TDR phase...

Already completed...

Engineering/modelling complete + key systematics solved.

- Storage ring lattice ✓
 - Polarized proton delivery ✓
 - Viable site + ground stability ✓
 - Prototype being built (strong UK input) ✓
- Main EDM measurement and systematics ✓
 - Counter-rotating beams/spin-alignment ✓
 - Hybrid ring + systematics from field limits ✓
 - Beam dimensions/polarisations/measurement ✓

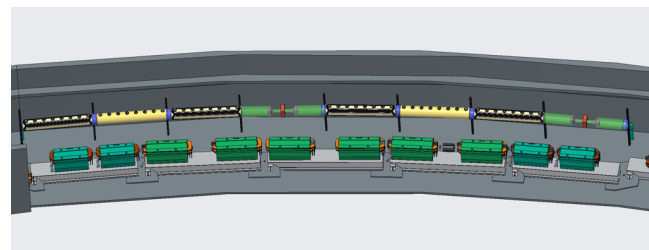

Top: 1/24 section (15°) of pEDM ring.
Right: pEDM deflector (designed and under construction in the UK).

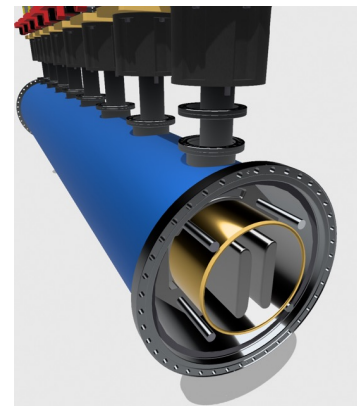

Work to be done...

- Precision beams studies (Muon g-2 experts).
- Options for improved polarimetry (e.g. CMOS).
- Alignment system, methodology and studies.
- Simulate 10^3 particles for 10^3 seconds beam lifetime.
- More realistic costing.
- **Build community/collaboration!**
 - Bring current pEDM communities together.
 - Increased UK involvement (you are invited!).
 - New generation to start and finish experiment.

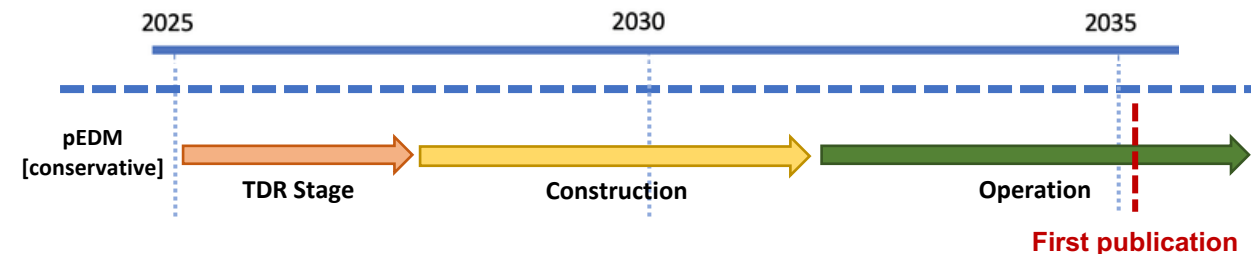

You can do this experiment and publish hugely important physics (e.g. solve the strong CP problem!) in < 20 years!

UK involvement in proton EDM

What the UK can provide:

World class physicists, accelerator scientists and engineering.

- 50-100% of critical bending components.
- Engineering/construction for deflectors/adjustors.
- Developing/building polarimeters (Si, CMOS).
 - In-line with recent STFC investment.
- Project management.
- Alignment experience.
- Simulation + high-statistics modelling.
- Accelerator experience (e.g. Cockcroft/JAI) – UK experiment??
- Lower cost than U.S. estimates.
- Building a UK pEDM consortium/collaboration.
 - Substantial UK expertise available.
 - New generation of physicists.
 - Please get in touch.



Imperial College
London

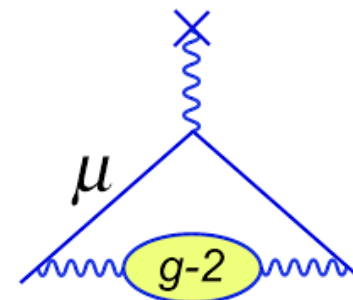

Conclusions

- pEDM experiment is the first direct search for the proton EDM.
- Improves on current (indirect) limit by $> \mathcal{O}(10^4)$.
- Directly address/solves the strong CP problem.
 - Strong CP/pEDM \leftrightarrow Astro + Particle + Nuclear.
- Significant new physics drivers:
 - CP-violation source for Baryon Asymmetry.
 - Sensitive probe for axionic dark-matter.
 - Probe light-weak new particles \rightarrow PeV-scale new physics.
 - No EDM would also be dramatic \rightarrow at SM limit.
- Major R&D completed / systematics understood.
- From TDR to final publication in < 20 years.
- One of the most low-cost/high-return proposals in particle physics today.

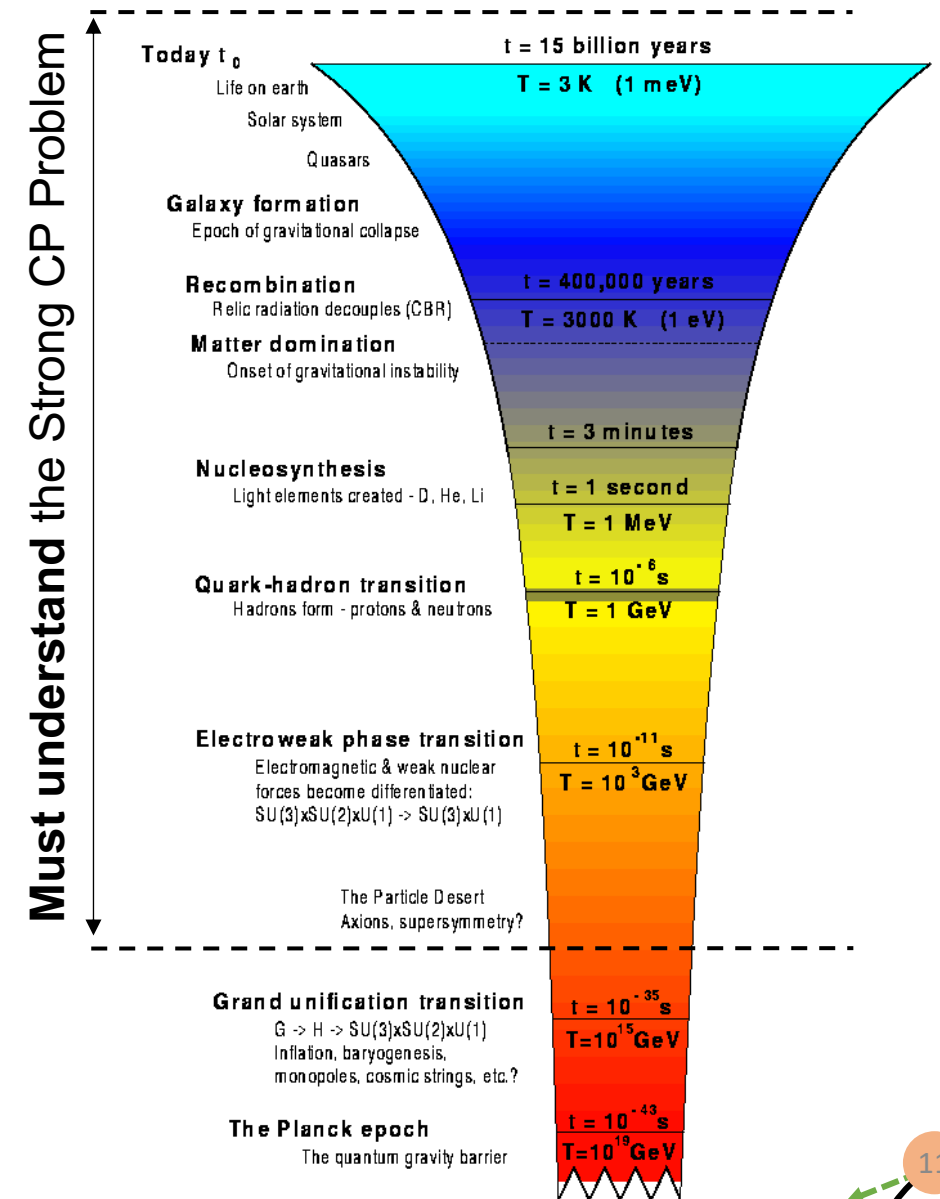

Conclusions

This is a beautiful experiment to precisely measure an angle...
You can be a part of it.

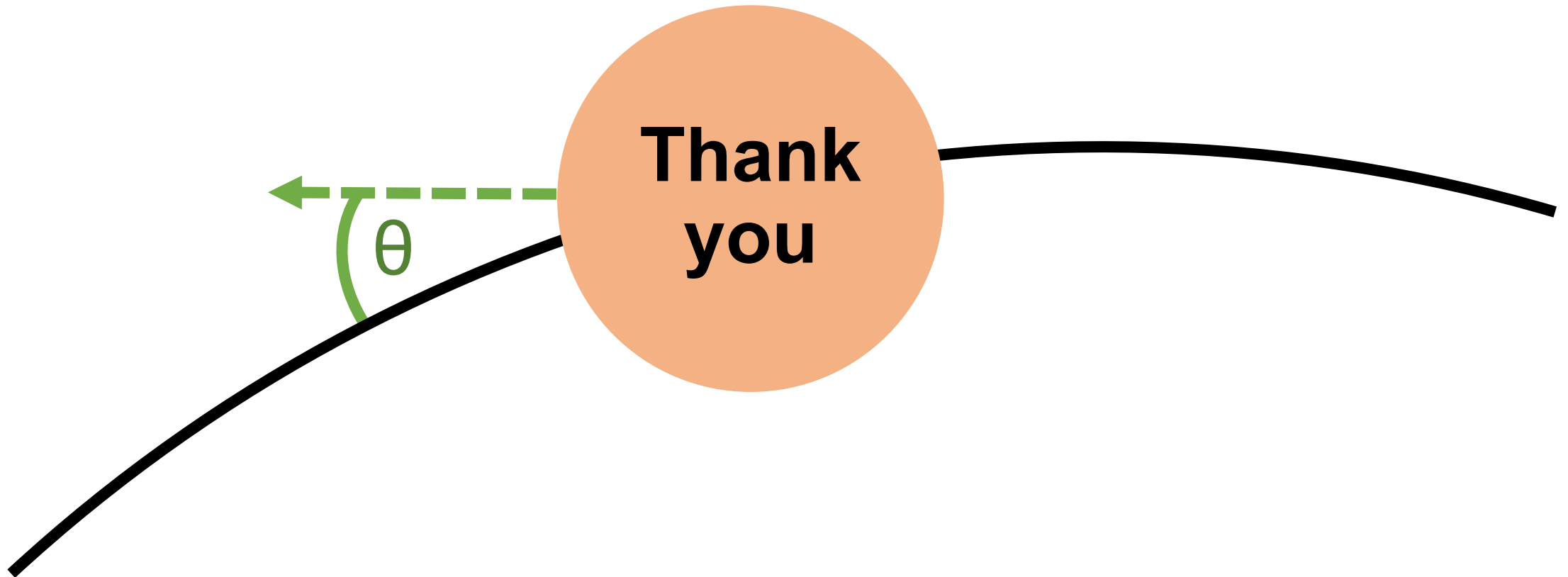

Backups

What is the proton EDM?

- The Dirac equation in an electric field gives rise to the EDM form factor, F_3 :

$$\Gamma^\mu = -ie \left[\gamma^\mu F_1(q^2) + (F_2(q^2) + iF_3(q^2)\gamma_5) \frac{i\sigma^{\mu\nu} q_\nu}{2m} \right]$$

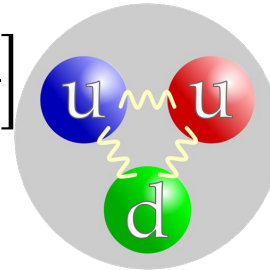

For the Proton (mass m_p , EDM d_p) $\rightarrow F_3(0) \propto 2m_p d_p$

- It is a measure of the overall polarity of the system:
 - i.e. the separation/distribution of positive (u) and negative (d) charge within the proton.
 - Charge asymmetry along the spin axis.
- External electric field + a non-zero, static EDM of the proton induces mechanical torque:
 - Uneven charge distribution + electric field = EDM-induced motion.
 - Not to be confused with magnetic dipole moment (g-2).
- A permanent EDM violates both P and T.
 - From CPT symmetry \rightarrow model-independent CP violation.

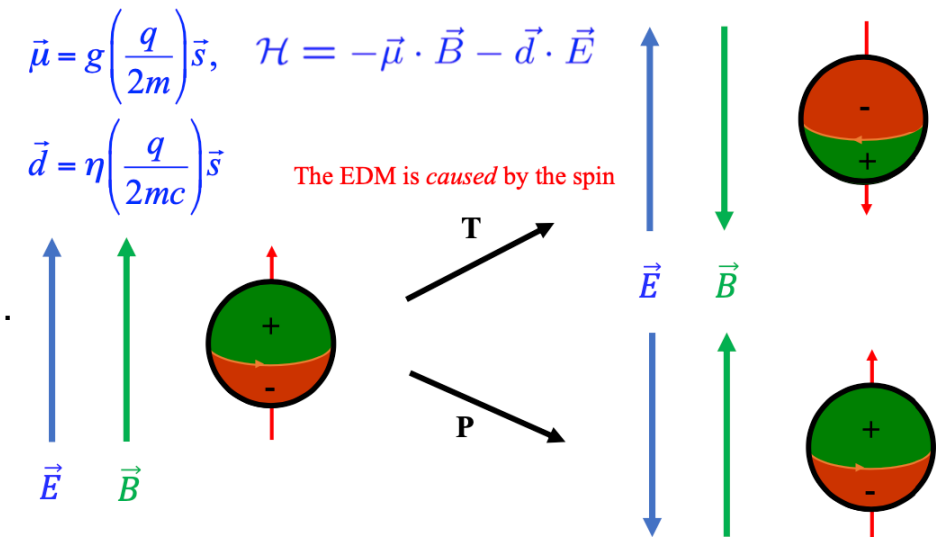
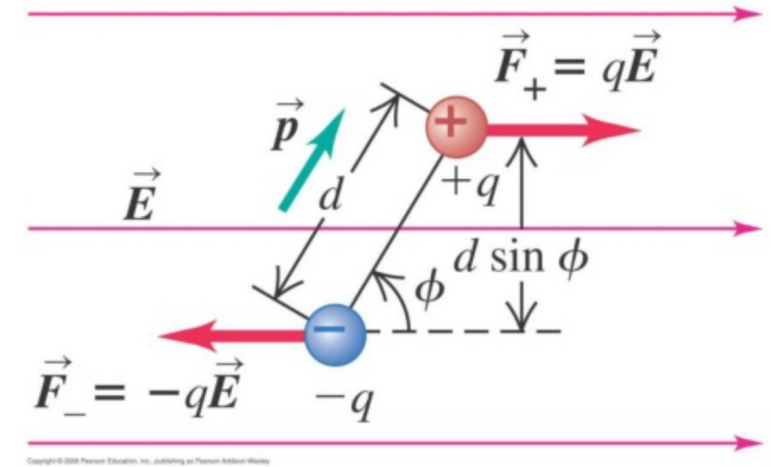

Strong CP Problem

$$\mathcal{L}_{QCD} = (\dots) + \frac{g^2}{32\pi^2} \bar{\theta} \tilde{G}_{\mu\nu}^a G^{\mu\nu a}$$

P-violating
 T-violating
CP-violating

BUT, we do not observe CP violation in strong interactions...

$$\bar{\theta} = \theta + \varphi$$

= QCD θ -term (non-perturbative) + quark mass phase.

$\bar{\theta} \tilde{G} G$ leads to non-zero nucleon (N) EDM $\rightarrow |\vec{d}_N| = \mathcal{O}(\theta)$.

SM: $|\bar{\theta}| \lesssim 10^{-10} \rightarrow |\vec{d}_N^{SM}| \lesssim 10^{-31} e \cdot cm \rightarrow$ **More fine tuning!**

\rightarrow No CP violation implies:

$$\bar{\theta} = \theta + \varphi = 0 \text{ (Fine tuning!)}$$

A non-zero proton EDM (pEDM), e.g. $10^{-24} e \cdot cm \gtrsim |\vec{d}_N| \gtrsim 10^{-30} e \cdot cm$:

- Unambiguous evidence of new physics (with no SM theory needed!).
- Solves strong CP-problem!

Strong CP problem

- **Baryon asymmetry** - Model-independent source of CP-violation needed.
- **Dark matter** - new U(1) symmetry + SSB \rightarrow pseudo-Goldstone boson, a = **axion**

~~$$\mathcal{L}_{QCD+a} = (\dots) + \frac{g^2}{32\pi^2} \bar{\theta} \tilde{G}_{\mu\nu}^a G^{\mu\nu a} - \frac{g^2}{32\pi^2} \frac{fa\bar{\theta}}{fa} \tilde{G}_{\mu\nu}^a G^{\mu\nu a}$$~~

\rightarrow Observed oscillating pEDM = possible signature of an axion-like DM particle.

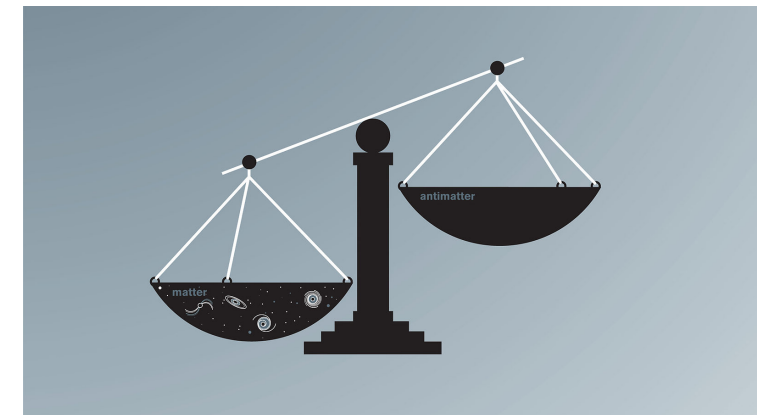

Proton EDM experiment sensitivity

- No current direct limit on pEDM! Best indirect limit from atomic physics is $|d_p^{\downarrow 199\text{Hg}}| < 2.0 \times 10^{-25} e \cdot \text{cm}$.
- Best current (direct) nEDM limit is $|\vec{d}_n| < 1.8 \times 10^{-26} e \cdot \text{cm}$.
- Remember, new physics in nucleon EDM range: $10^{-24} e \cdot \text{cm} \gtrsim |\vec{d}_N| \gtrsim 10^{-30} e \cdot \text{cm}$...

J. Alexander *et al.* [srEDM collaboration], arXiv:2205.00830.

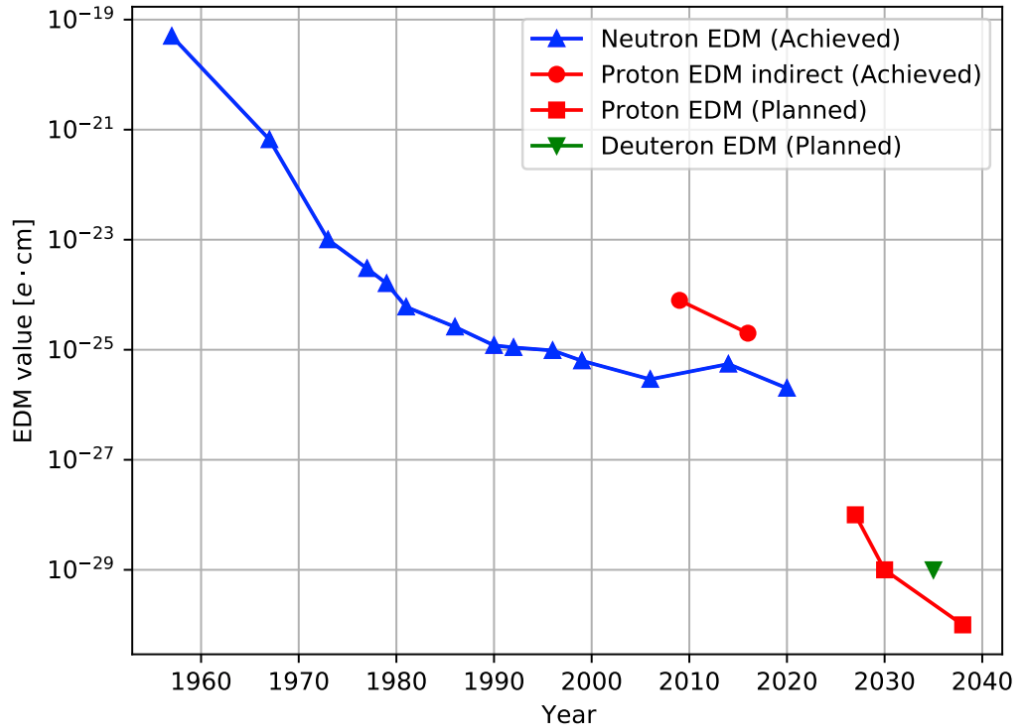

F. Abusaif *et al.* [CPEDM collaboration], arXiv:1912.07881.

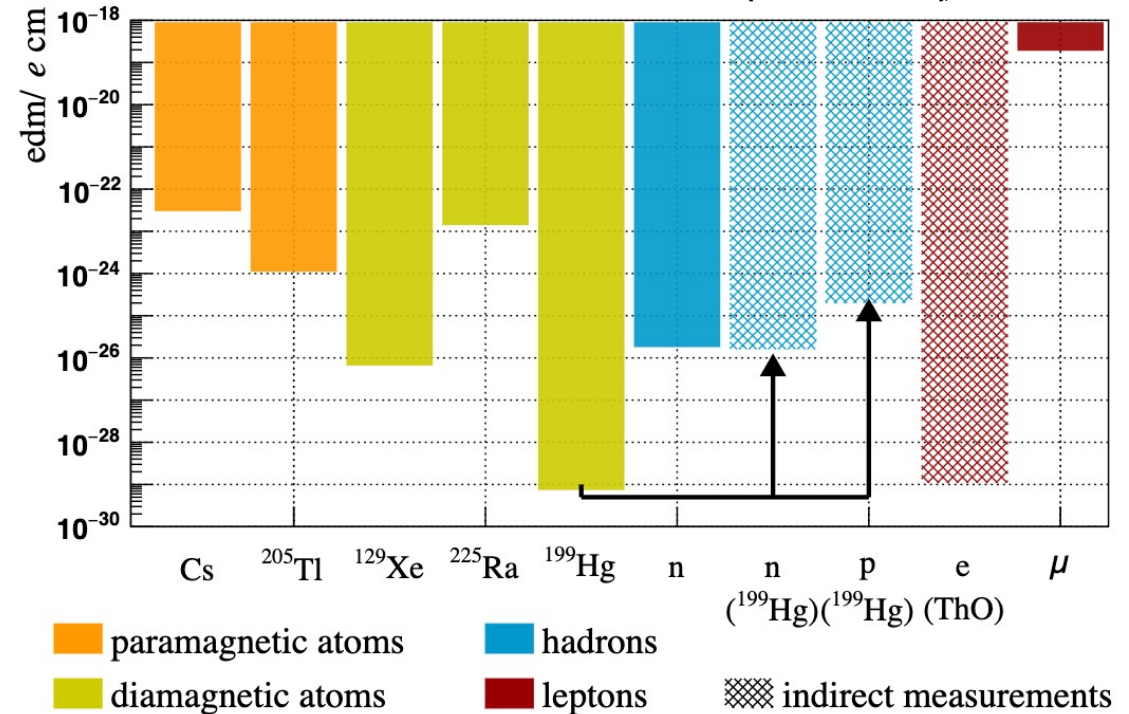

First-ever direct proton EDM measurement will have a sensitivity of $10^{-29} e \cdot \text{cm}$!

Take-home message: 4 orders of magnitude on pEDM, three orders of magnitude on θ_{QCD} .

Physics complementarity

pEDM new physics (NP) with scale Λ_{NP} is quantum loop induced (by virtue of uncertainty principle):

$$d_p \sim (g^2/16\pi^2) (e m_q)/\Lambda_{\text{NP}}^2 \sin \phi^{\text{NP}} e \cdot cm$$

m_q = mass of 1-loop quark, ϕ^{NP} = complex CP violation phase of NP

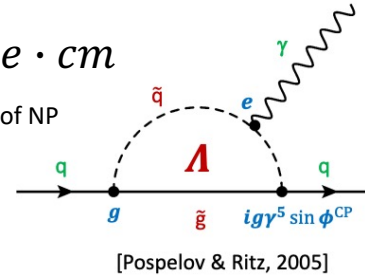

- Probe new physics of $\mathcal{O}(\text{PeV})$ mass scale!
 - $\phi^{\text{NP}} \sim 1$, $\Lambda_{\text{NP}} \sim 3 \times 10^3 \text{ TeV}$. W. Marciano (2020)
 - Complementary to e.g. LHC/FCC programme.
- Probe light, weakly-interacting new physics.
 - $\Lambda_{\text{NP}} \sim 1 \text{ GeV}$, $g \lesssim 3 \times 10^{-5}$, $\phi^{\text{NP}} \sim 10^{-10}$. Z. Omarov et al., PRD 105 (2022) 032001.
 - Complementary to e.g. LZ, LDMX, FASER, SHiP.
- Highly complementary to atomic/molecular EDM experiments.
 - Potential to also measure deuteron / ^3He EDMs.

J. Alexander et al. [srEDM collaboration], arXiv:2205.00830.

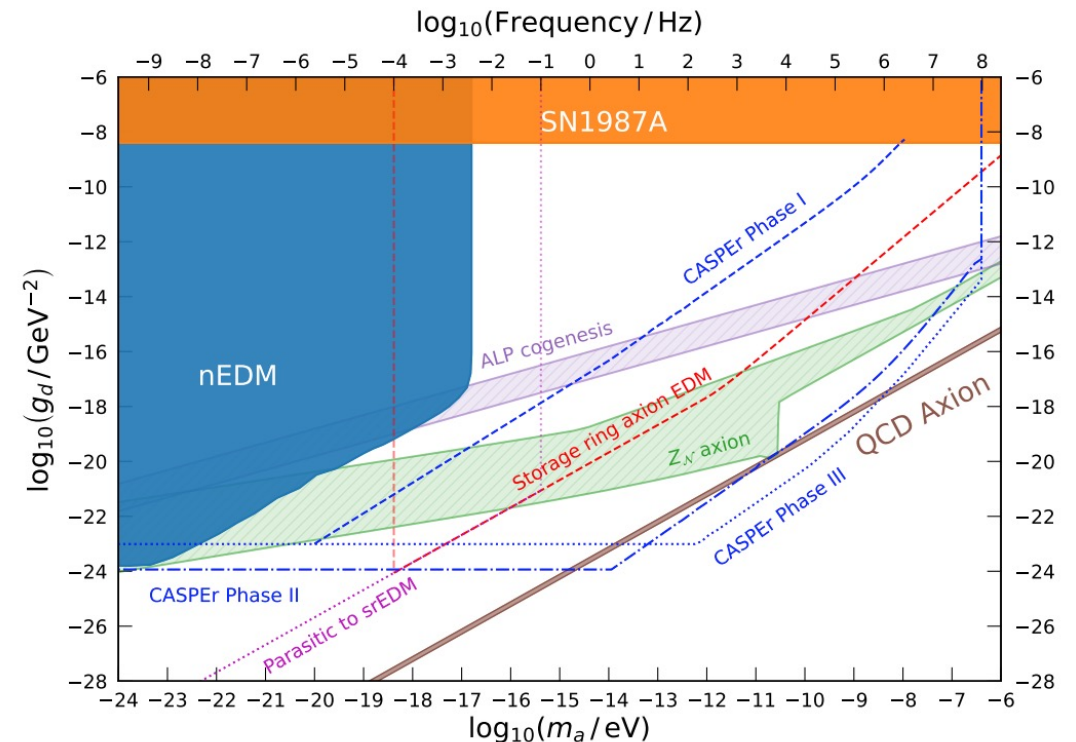

Importantly, pEDM will clearly be highly complementary to nEDM experiments...

→ But, pEDM wins the statistics battle.

Ring lattice systematic studies

Table 8: Classification of systematic error sources

Source	Severity of effect; counter-measures	Risk level; Comments
Vertical electric field.	Primary effect, unavoidable when magnetic focusing is used. It cancels with clock-wise (CW) vs. counter-clock-wise (CCW) storage simultaneously.	Risk level: Low. If CW vs. CCW storage is not simultaneous it may become medium-high risk due to the unknown time-stability of vertical electric fields (not considered in present experiment).
Background radial magnetic fields.	They can be a systematic error source when electric focusing is present. Applying large radial magnetic fields around the ring can probe electric focusing in the ring (spin-based alignment).	Risk level: Low. No need for expensive magnetic field shielding, just Helmholtz wires mounted on the vacuum chambers. Time dependent small B-fields OK if their amplitude and direction are monitored. Applying appropriate electric focusing can also probe background magnetic fields.
Vertical velocity effect.	A major issue with non-symmetric lattices, not an issue here. Symmetry: Placing the magnetic quads at highly symmetric locations, greatly reduces their required placement accuracy.	Risk level: Low. Moving vertically in a radial E-field region, creates a longitudinal magnetic field in the particle's rest frame. The experiment will start with 0.1 mm accuracy in the quad placement. Eventually, we aim to achieve a placement accuracy better than 0.01 mm for each magnetic quad using spin-based alignment.
Geometrical phases, high-order vertical E-fields.	Under control with placement accuracy of lattice elements better than 0.1 mm and by flipping the current of the magnetic quadrupoles to better than 0.1% at each storage.	Risk level: Low. It's important to keep the beam planarity to within 0.1 mm and the beam separation between CW and CCW beams to below 0.01 mm. The risk comes from the time stability of the lattice elements if they move more than the 0.01 mm level per hour. Spin-based alignment can be used as needed to realign lattice.
Polarimeter related systematic errors.	Need paying attention to the relevant issues at design level. Storing beam with opposite polarization direction is critical in canceling rate related effects as well as effects related to beam-motion.	Risk level: Medium-low. Potentially serious issues can also come from beam-profile vertical polarization dependence. Prototype polarimeter-related systematic errors were studied first at KVI/The Netherlands and at COSY/Germany. Opposite polarizations were used to cancel the asymmetry systematic errors to 10^{-5} level, limited by statistics within a factor of ten to needed accuracy. It is not expected to be any issue improving the accuracy with more statistics available.

Table 9: Electric field alignment sequence including magnetic quad current flipping.

E-field direction alignment	Vertical spin precession rate	Comments
Mechanical, < 1 mrad average alignment. (It is also possible to mechanically align the electric field plates to better than $10 \mu\text{rad}$ with respect to gravity, which we will evaluate further later on, but here we assume much more relaxed alignment specs.)	< 2.5 krad/s.	Beam planarity of 0.1 mm out of specs; CW and CCW beam separation difference of 0.01 mm out of specs. We need to be able to align the plates of each section to better than 0.1 mrad to be able to store beam.
Beam-based alignment, to obtain an average electric field plate alignment of better than $2 \mu\text{rad}$, with an average $E_V < 10$ V/m. Aligning the plates to few μrad per section (12.5m) using trim electric field plates.	< 5 rad/s.	Compensate the average vertical E-field better than $E_V = 10$ V/m by keeping the beam planarity to better than $\pm 50 \mu\text{m}$. Keep one beam direction (e.g., CW) at zero vertical spin precession rate within available statistics.
Spin-based alignment, to obtain an average vertical electric field alignment of $E_V < 20 \mu\text{V/m}$ every second.	$< 10 \mu\text{rad/s}$.	Always keep one beam direction (e.g., CW) at zero vertical spin precession rate within available statistics by applying correction voltage on the trim electric field plates.
Spin-based alignment to reduce electric focusing below $m < 10^{-7}$ and align each magnetic quad better than $10 \mu\text{m}$.	$< 1 \mu\text{rad/s}$.	Always keep one beam direction (e.g., CW) at zero vertical spin precession rate within available statistics. Measure and reduce the CW and CCW beam separation to less than $\pm 5 \mu\text{m}$. The ring is designed with stability of the electric focusing and quad offset parameters in mind.
Spin-based alignment, $E_V < 2 \mu\text{V/m}$ every second using the trim electric field plates.	$< 0.1 \mu\text{rad/s}$.	Flip the magnetic quadrupole currents. Always keep one beam direction (e.g., CW) at zero vertical spin precession rate within available statistics. The EDM signal is the difference between the CW and CCW vertical precession rates while combining all quad current settings including information from radially polarized bunches.

A Permanent EDM Violates both T & P Symmetries:

$$\vec{\mu} = g \left(\frac{q}{2m} \right) \vec{s}, \quad \mathcal{H} = -\vec{\mu} \cdot \vec{B} - \vec{d} \cdot \vec{E}$$

$$\vec{d} = \eta \left(\frac{q}{2mc} \right) \vec{s}$$

The EDM is *caused* by the spin

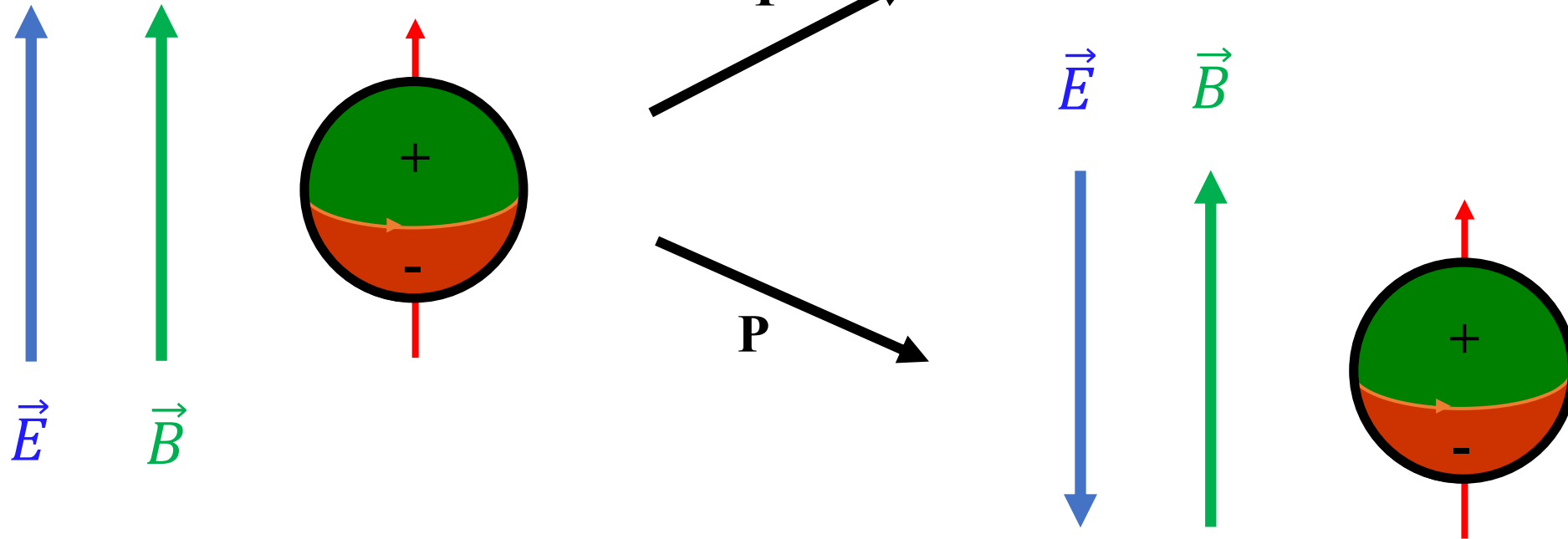

Reminder: batteries are allowed in the SM!

EDM timelines, from Snowmass 2021 (2022).

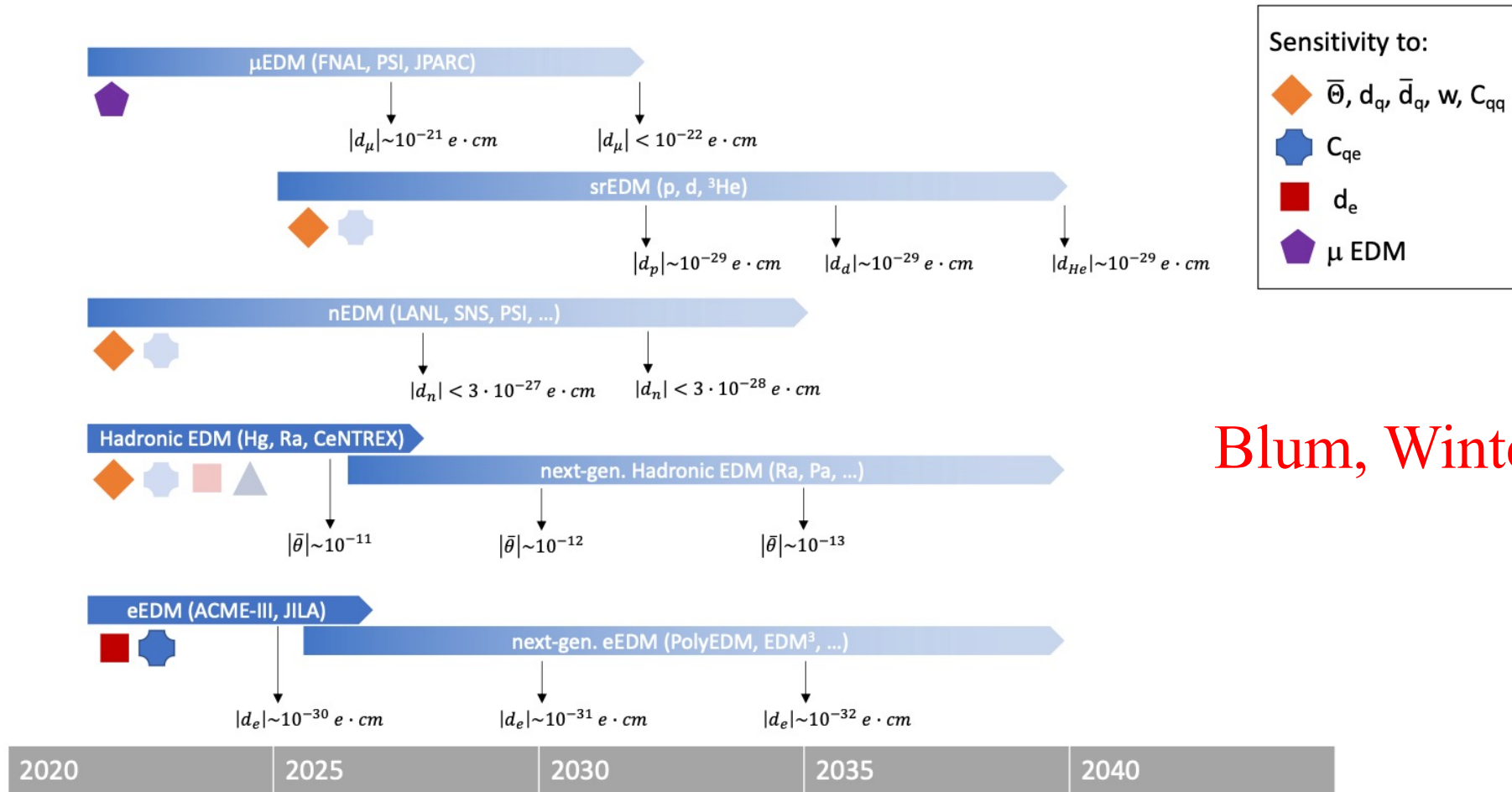

Blum, Winter *et al.*

Figure 3-1. Timelines for the major current and planned EDM searches with their sensitivity to the important parameters of the effective field theory (see Fig. 3-2 for details). Solid (shaded) symbols indicate each experiment’s primary (secondary) sensitivities. Measurement goals indicated by the black arrows are based on current plans of the various groups.

Snowmass paper on EDMs

Neutron EDM

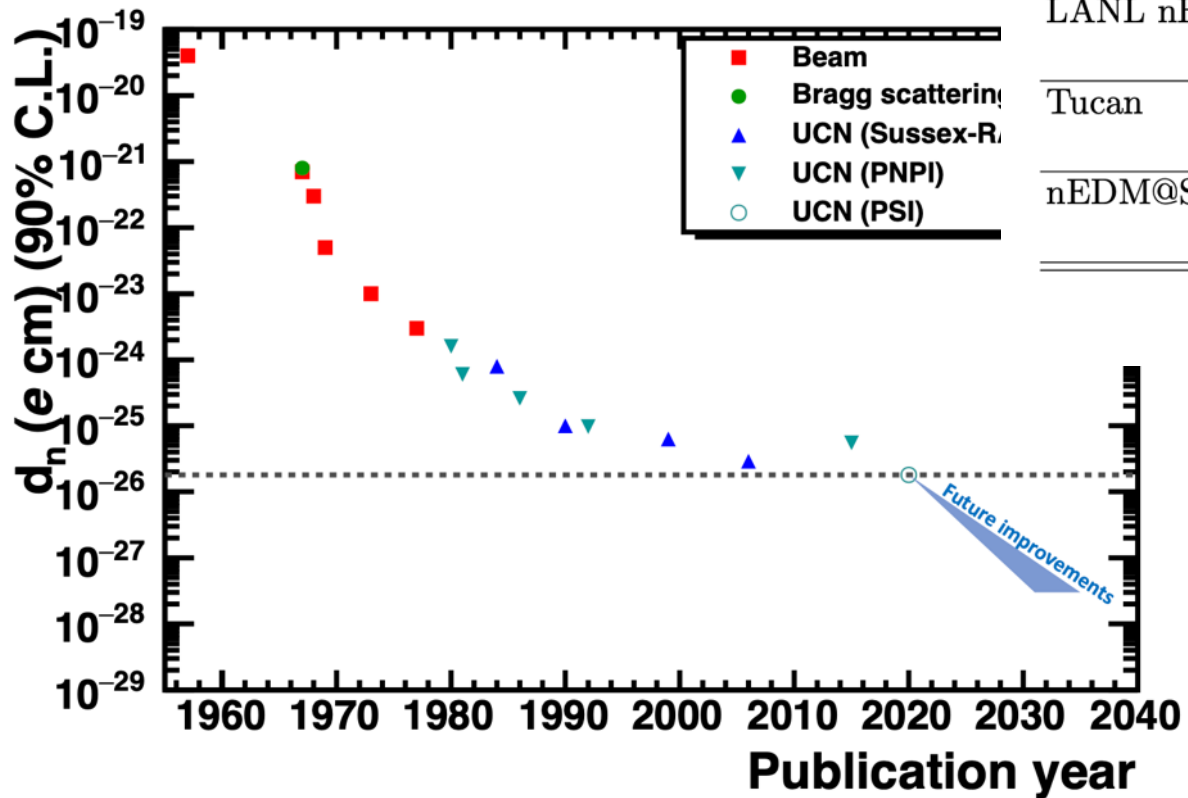

Experiment	Location	UCN source	Features	Ref.
n2EDM	PSI	Spallation, SD ₂	Ramsey method, double cell, ¹⁹⁹ Hg comagnetometer	[152]
PanEDM	ILL	Reactor, LHe	Ramsey method, double cell, ¹⁹⁹ Hg comagnetometer	[153]
LANL nEDM	LANL	Spallation, SD ₂	Ramsey method, double cell, ¹⁹⁹ Hg comagnetometer	[135]
Tucan	TRIUMF	Spallation, LHe	Ramsey method, double cell, ¹²⁹ Xe comagnetometer	[154]
nEDM@SNS	ORNL	In-situ production in LHe	Cryogenic, double cell, ³ He comagnetometer, ³ He as the spin analyzer	[139]

TABLE III. A list of the nEDM experiments that are being developed

FIG. 3. Evolution of the nEDM results along with projected future results

Snowmass paper on EDMs

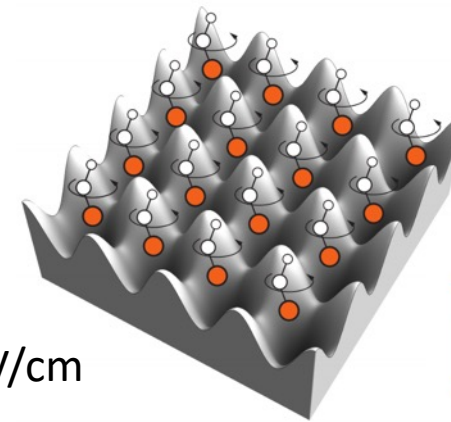

PolyEDM

Effective E-field with polar molecules: order GV/cm

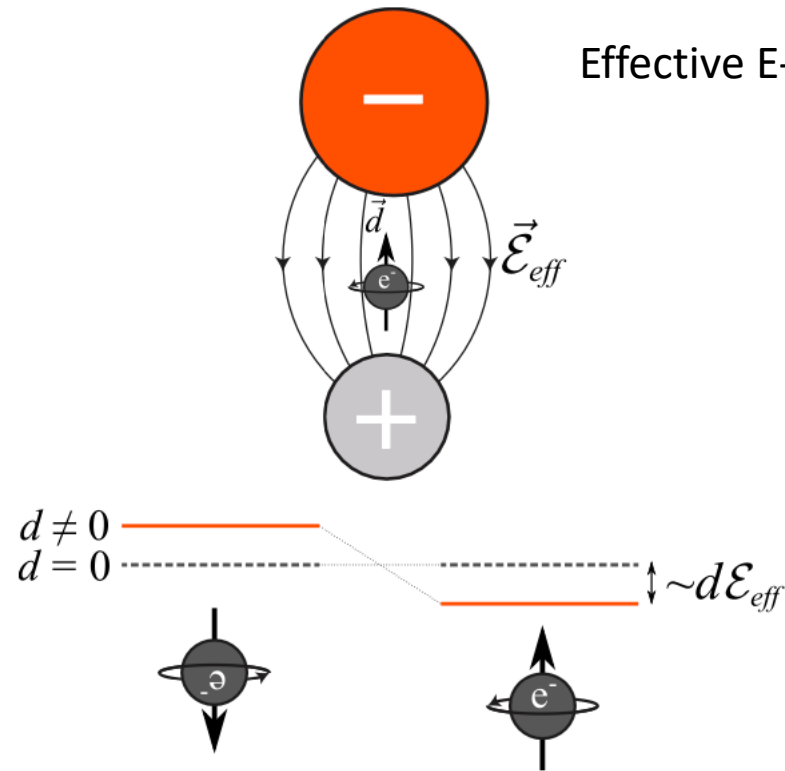

Figure: Laser-cooled polyatomic molecules, optically trapped, with full quantum control. Such a platform can be used to access new physics at the PeV scale.

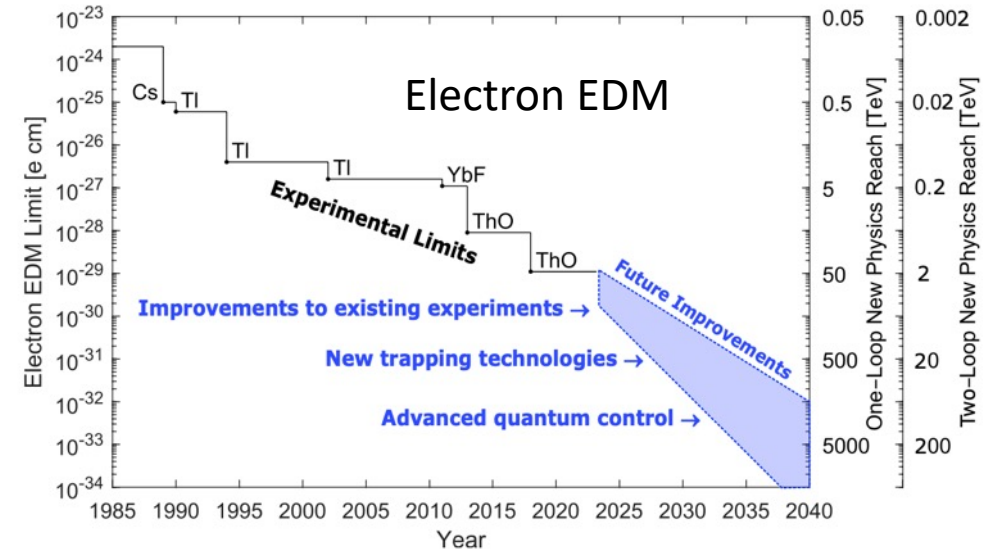

FIG. 5. Electron EDM limits versus time, along with new physics reach for one-loop and two-loop effects (see Eq. 2). All electron EDM experiments to date use AMO techniques. The solid line indicates the most sensitive experimental limit, including the species used. The shaded area indicates potential future improvements discussed in the text. Improvements in the next few years are driven largely by improvements to existing experiments and are quite likely, though as we go more into the future the projection becomes increasingly speculative and uncertain.

High intensity polarized proton Beam at BNL

Proton intensity at Booster input $3 \cdot 10^{11}$.
The vertical scale is normalized 95% emittance.

The corresponding normalized rms emittance at 10^{11} is 0.7π horizontal, 1.0π vertical for horizontal scraping.

Intensity: $15 \sim 2e11$ protons

@ 10^{11}

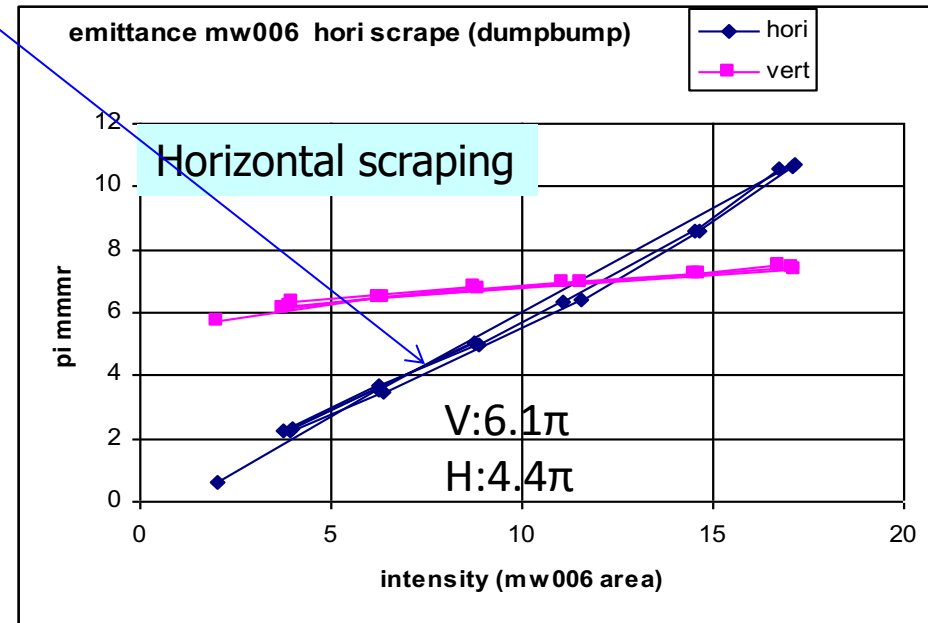
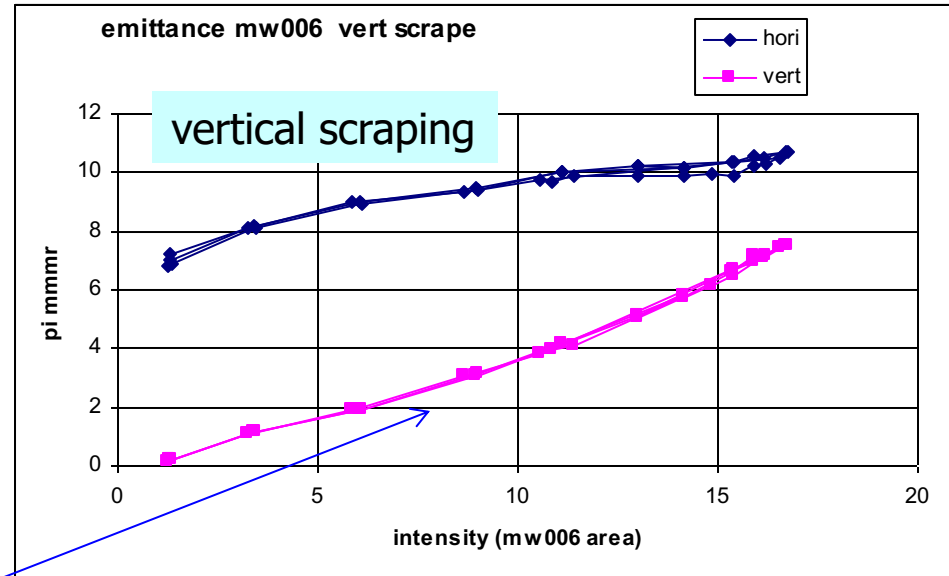
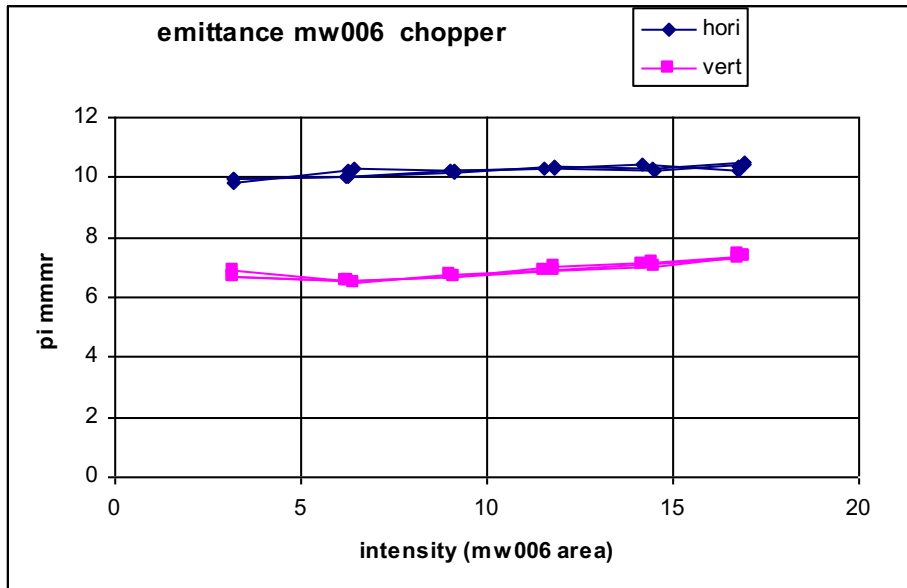

Large statistics available, opportunity for great sensitivity improvement in EDMs

Hybrid, symmetric lattice storage ring, designed by Val. Lebedev (FNAL)

Z. Omarov *et al.*, PHYS. REV. D **105**, 032001 (2022)

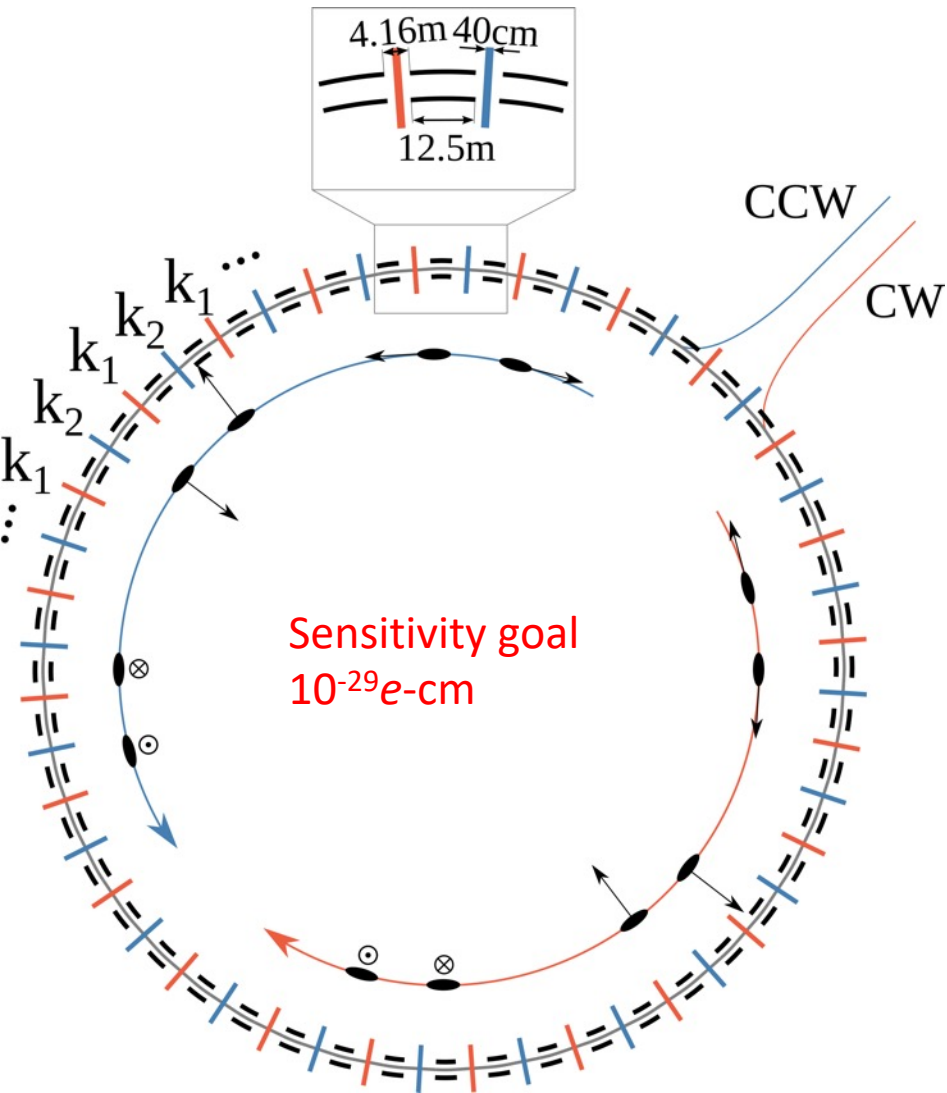

TABLE I. Ring and beam parameters for Symmetric Hybrid ring design

Quantity	Value
Bending Radius R_0	95.49 m
Number of periods	24
Electrode spacing	4 cm
Electrode height	20 cm
Deflector shape	cylindrical
Radial bending E -field	4.4 MV/m
Straight section length	4.16 m
Quadrupole length	0.4 m
Quadrupole strength	± 0.21 T/m
Bending section length	12.5 m
Bending section circumference	600 m
Total circumference	799.68 m
Cyclotron frequency	224 kHz
Revolution time	4.46 μ s
$\beta_x^{\max}, \beta_y^{\max}$	64.54 m, 77.39 m
Dispersion, D_x^{\max}	33.81 m
Tunes, Q_x, Q_y	2.699, 2.245
Slip factor, $\eta = \frac{dt}{t} / \frac{dp}{p}$	-0.253
Momentum acceptance, (dp/p)	5.2×10^{-4}
Horizontal acceptance [mm mrad]	4.8
RMS emittance [mm mrad], ϵ_x, ϵ_y	0.214, 0.250
RMS momentum spread	1.177×10^{-4}
Particles per bunch	1.17×10^8
RF voltage	1.89 kV
Harmonic number, h	80
Synchrotron tune, Q_s	3.81×10^{-3}
Bucket height, $\Delta p/p_{\text{bucket}}$	3.77×10^{-4}
Bucket length	10 m
RMS bunch length, σ_s	0.994 m

Low risk



Strong focusing



The proton EDM in the AGS tunnel at BNL

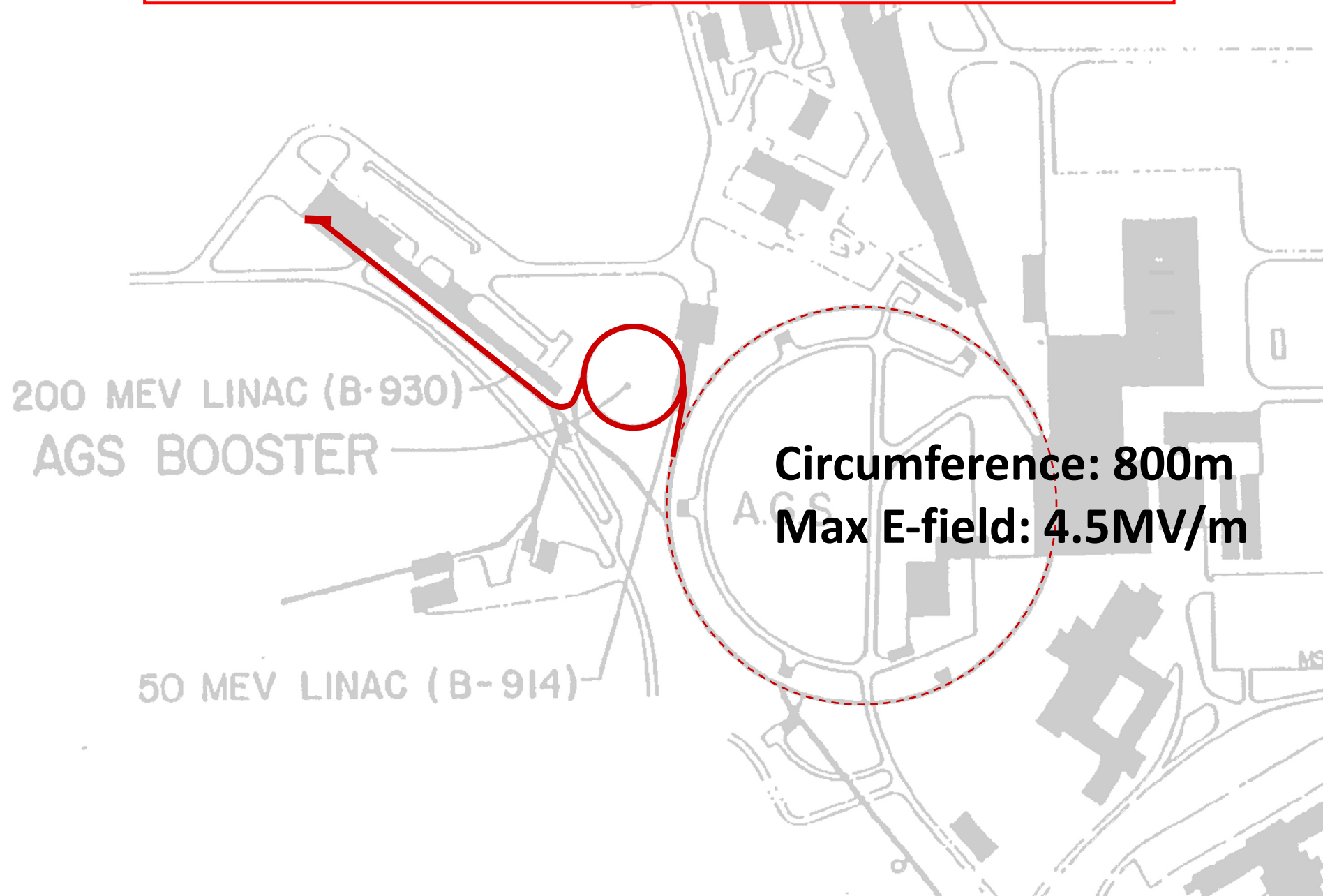

Phase-space matched injection from Booster to the proton EDM ring studied and shown to be possible.

Booster-to-AGS BtA

Booster

Proposed EDM Ring

2nd Inj. Line

AGS

Beam Injection points

Q12 of BtA

1st Inj. Line

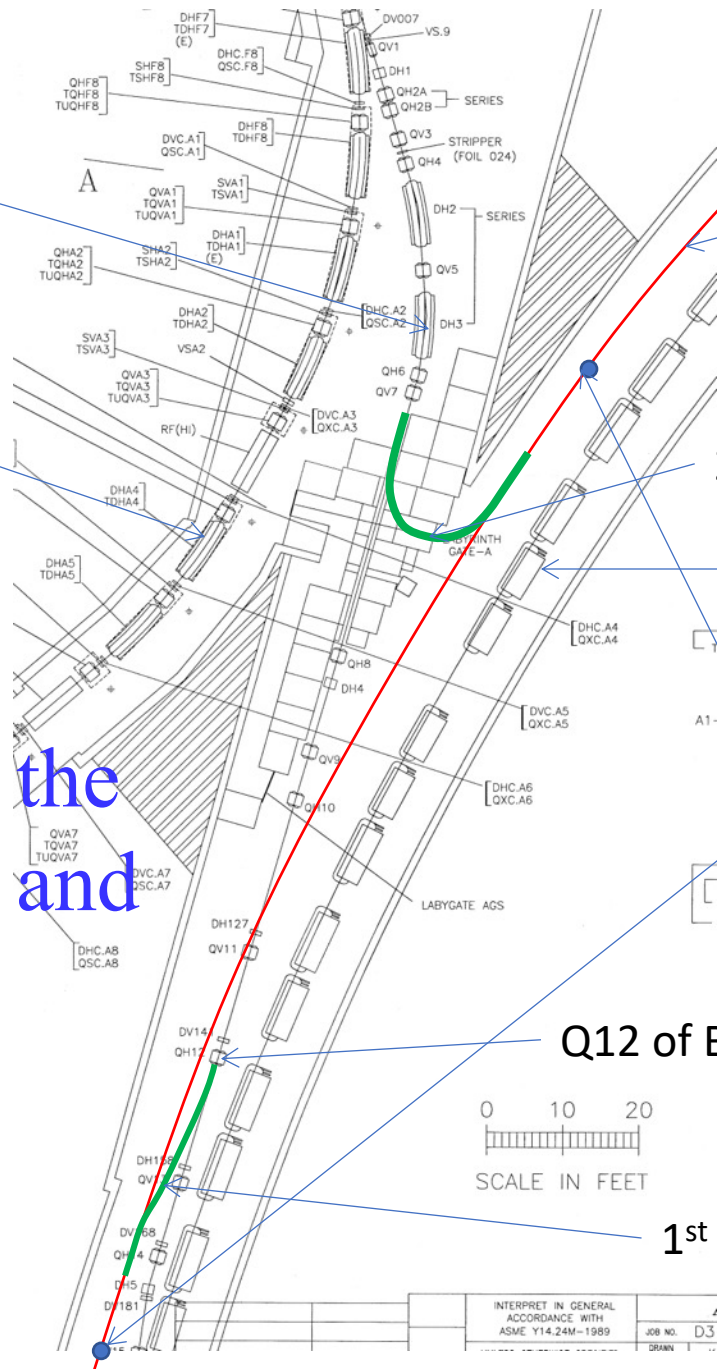

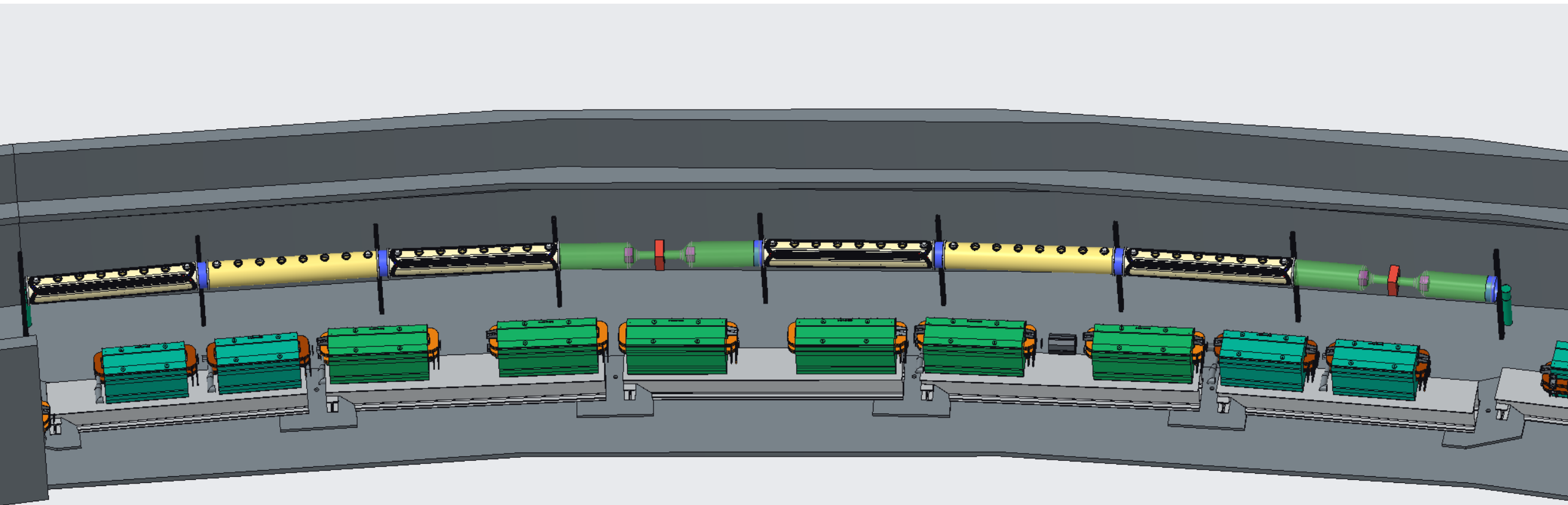

1/24 section (15°) of pEDM ring

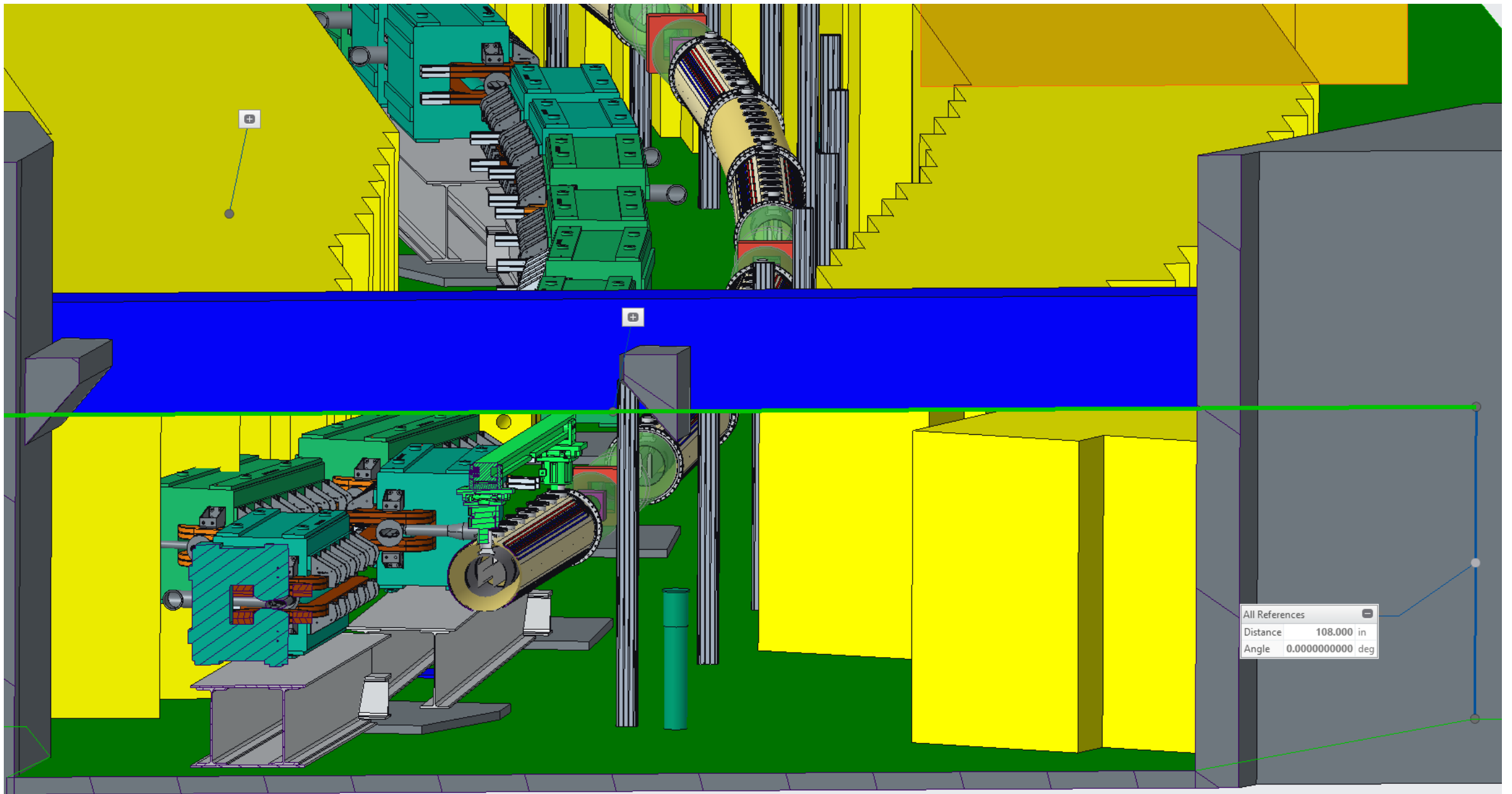

Section at F20 experimental blockhouse
Note: ceiling elevation = 108" (9'-0")

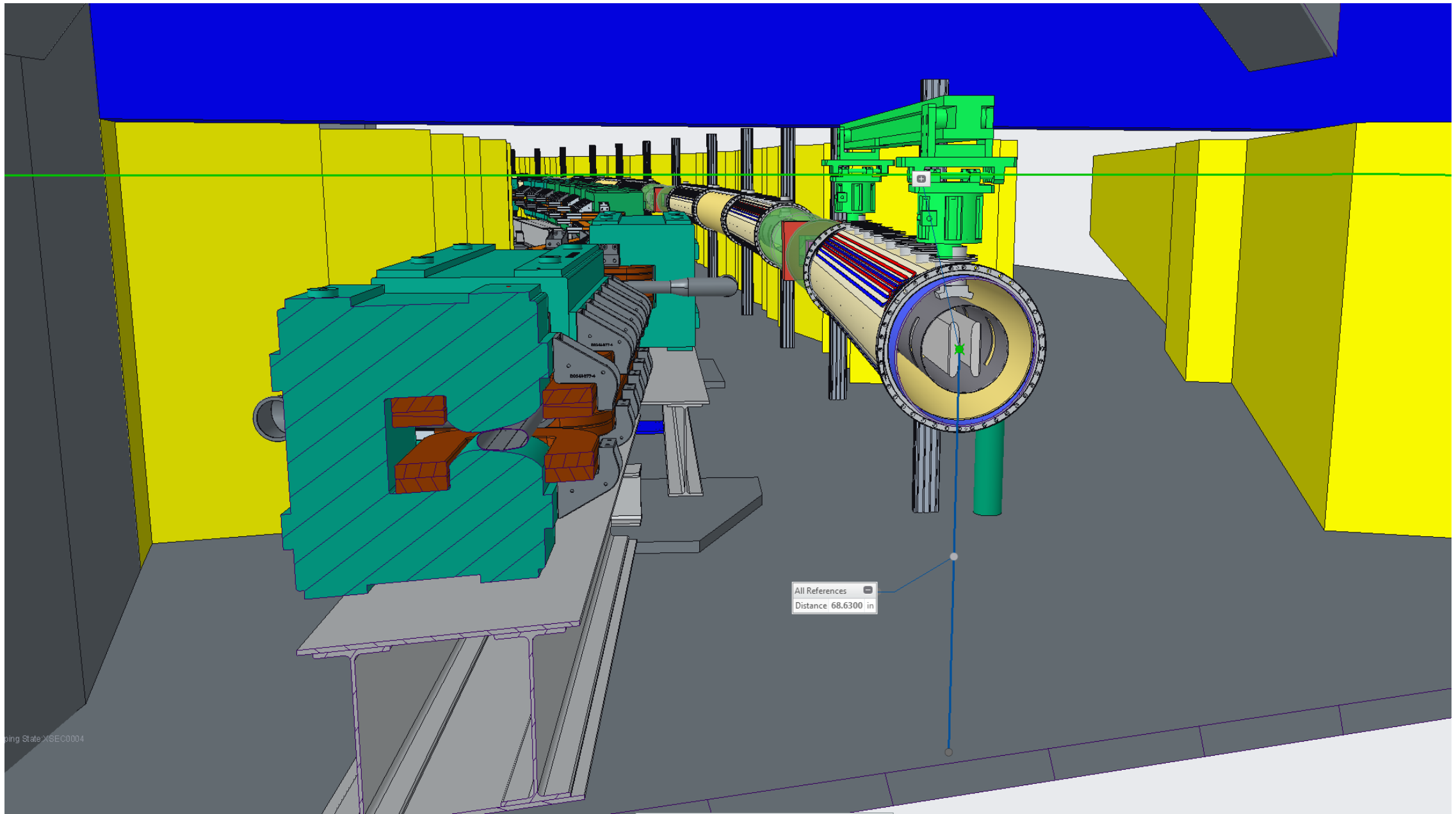

Section at F20 experimental blockhouse
Note: preliminary ring elevation (centerline) = 68.63"

Magnetic field corrections/generation

- Outside coils to generate vertical, and radial magnetic fields. Perhaps longitudinal B-fields too.
- Correction coils are used to
 - Eliminate outside B-fields
 - Probe electric field multipoles
- Our correction coils should not generate unwanted longitudinal B-fields (needs to be specked)

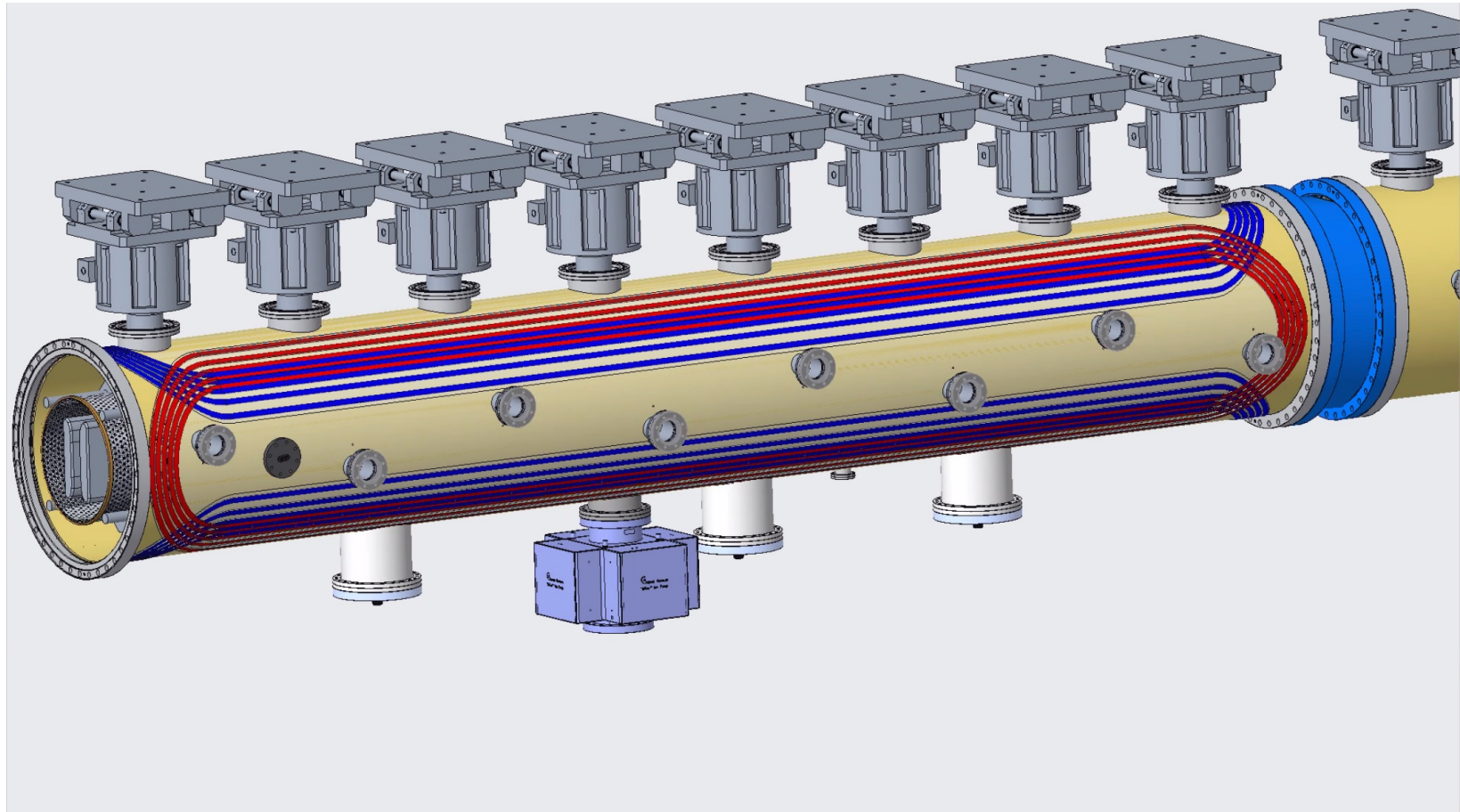

- Liverpool is designing the plates, and their support. Involved in their construction, high accuracy electric field estimations, methods to minimize them...

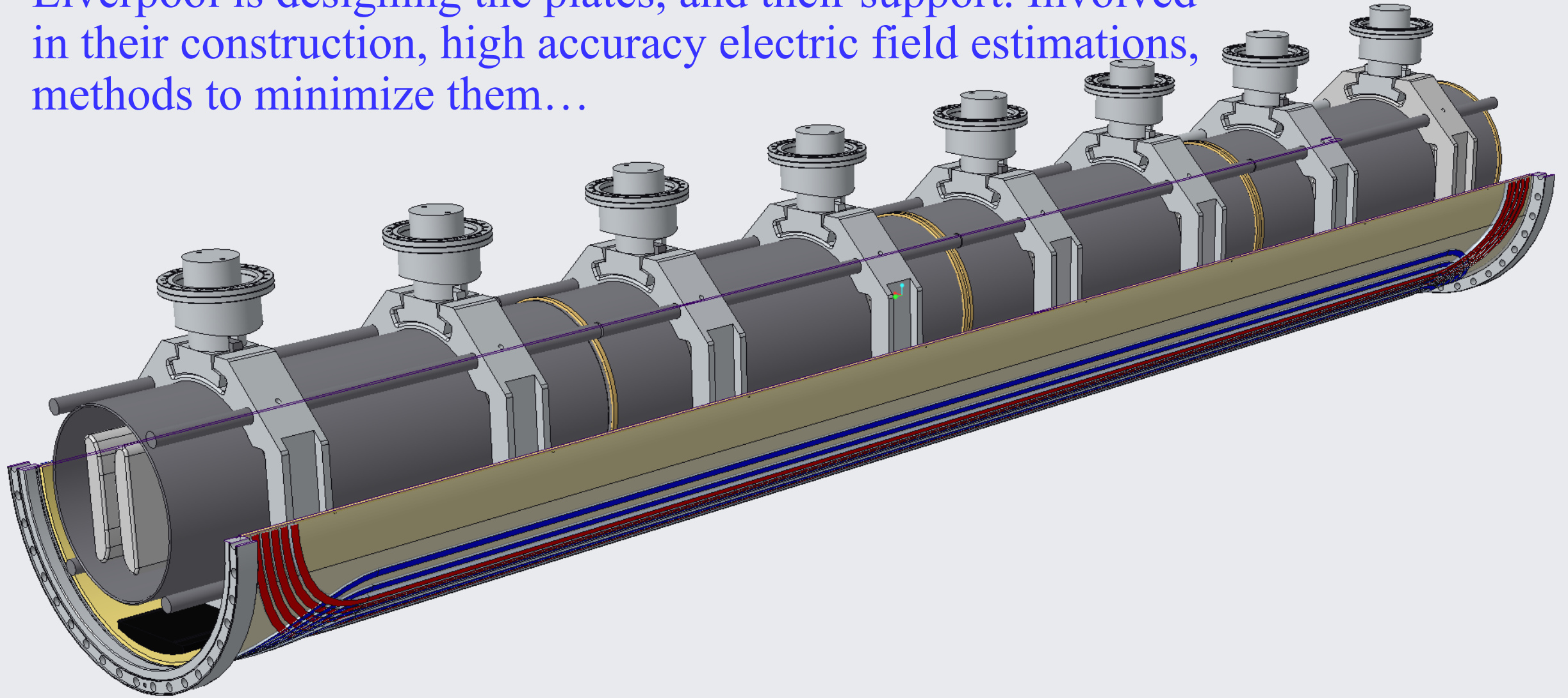

4m “Deflection” chamber partial section

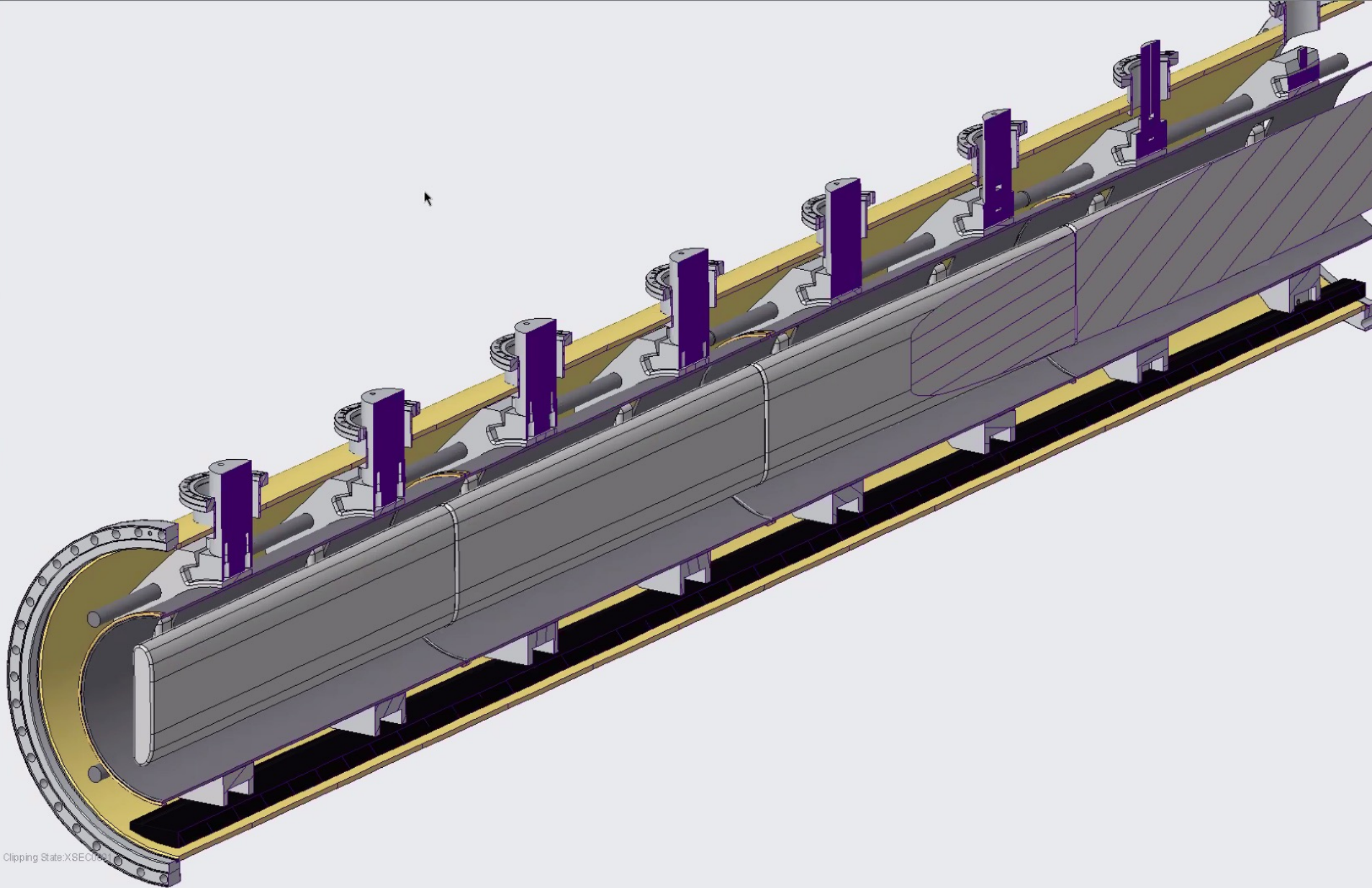

4m "Deflection" chamber partial section