



«ETTORE MAJORANA» FOUNDATION AND CENTRE FOR SCIENTIFIC CULTURE

TO PAY A PERMANENT TRIBUTE TO GALILEO GALILEI, FOUNDER OF MODERN SCIENCE,
AND TO ENRICO FERMI, THE "ITALIAN NAVIGATOR", FATHER OF THE WEAK FORCES



INFN ELOISATRON PROJECT

42nd Workshop:

INNOVATIVE DETECTORS FOR SUPERCOLLIDERS

ERICE-SICILY: 28 SEPTEMBER - 4 OCTOBER 2003

Radiation Damage and Long-term Aging in Gas Detectors

M. Titov,
Freiburg University / ITEP Moscow

Aging Phenomena in Gaseous Detectors: where are we now (I)?

A permanent degradation of operating characteristics under sustained irradiation, has been and still remains the main limitation to their use in high-rate experiments

Nuclear Instruments and Methods in Physics Research A252 (1986) 547–563
North-Holland, Amsterdam

547

REVIEW OF WIRE CHAMBER AGING *

J. VA'VRA

Stanford Linear Accelerator Center, Stanford University, Stanford, California 04305, USA

This paper makes an overview of the wire chamber aging problems as a function of various chamber design parameters. It emphasizes the chemistry point of view and many examples are drawn from the plasma chemistry field as a guidance for a possible effort in the wire chamber field. The paper emphasizes the necessity of tuning of variables, the importance of purity of the wire chamber environment as well as it provides a practical list of presently known recommendations. In addition, several models of the wire chamber aging are qualitatively discussed. The paper is based on a summary talk given at the Wire Chamber Aging Workshop held at LBL, Berkeley on January 16-17, 1986. Presented also at Wire Chamber Conference, Vienna, February 25-28, 1986.

436

Nuclear Instruments and Methods in Physics Research A300 (1991) 436–479
North-Holland

Wire chamber aging *

John A. Kadyk

Lawrence Berkeley Laboratory, 1 Cyclotron Road, Berkeley, CA 94720, USA

Received 27 June 1990

An overview of wire chamber aging is presented. A history of wire aging studies and the manifestations of wire aging are reviewed. Fundamental chemical principles relating to wire chamber operation are presented, and the dependences of wire aging on certain wire chamber operating parameters are discussed. Aging results from experimental detectors and laboratory experiments are summarized. Techniques for analysis of wire deposits and compositions of such deposits are discussed. Some effects of wire material and gas additives on wire aging are interpreted in chemical terms. A chemical model of wire aging is developed, and similarities of wire chamber plasmas to low-pressure rf-discharge plasmas are suggested. Procedures recommended for reducing wire aging effects are summarized.



ELSEVIER

Nuclear Instruments and Methods in Physics Research A 381 (1996) 289–319

NUCLEAR
INSTRUMENTS
& METHODS
IN PHYSICS
RESEARCH
Section A

Ageing of microstrip gas chambers: problems and solutions

R. Bouclier, M. Capeáns*, C. Garbatos, G. Manzin, G. Million, L. Ropelewski, F. Sauli,
L. Shekhtman, K. Silander, T. Ropelewski-Temmel

CERN, CH-1211 Geneva 23, Switzerland

Received 5 March 1996

Abstract

The experimental setup and the procedures used for studying the long-term behaviour of micro-strip gas chambers under sustained irradiation are described in detail. The most significant measurements on ageing obtained in a variety of conditions are reported, and a tentative interpretation of the results is presented. The relevance of these findings for the conception, construction and use of MSGCs trackers in high luminosity LHC detectors is discussed.

It is difficult to understand truly
any present aging measurement
and extrapolate it to other
operating conditions
!!! Reality is a complex mixture
of many processes

Aging Phenomena in Gaseous Detectors: where are we now (II)?

Proceedings of the
Workshop on Radiation Damage to
Wire Chambers

Lawrence Berkeley Laboratory, Berkeley, California

January 16-17, 1986

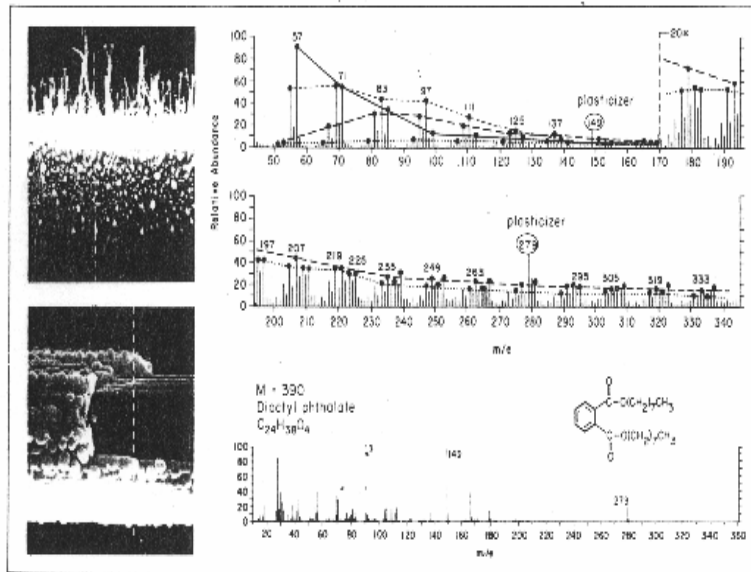

April 1986

Lawrence Berkeley Laboratory
University of California
Berkeley, California 94720

High Energy Physics Experiments are currently entering a new era which requires the operation of gaseous particle detectors at unprecedented high rates and integrated particle fluxes.

International Workshop on AGING PHENOMENA IN GASEOUS DETECTORS

DESY, Hamburg October 2-5, 2001

Topics will include:

- Coping with classical aging problems
- New aging effects
- Models and new insights from plasma chemistry
- Materials: Lessons for detectors and gas systems
- Experiences with large detector systems
- Recommendations for future detectors

Deadline for registration: August 1, 2001

Deadline for submission of abstracts: June 29, 2001

Proceedings to be published in Nuclear Instruments and Methods A

International Advisory Committee

M. Danilov (ITEP Moscow) V. Peskov (Lund)
B. Dolgoshein (MEPHI Moscow) F. Sauli (CERN)
D. Froidevaux (CERN) I. Shipsey (Purdue)
J. Kadyk (LBL) J. Va'va (SLAC)
P. Krizan (Ljubljana) A. Wagner (DESY)

Local Organizing Committee

M. Hohlmann (chair, DESY)
C. Padilla (DESY)
N. Tesch (DESY)
M. Titov (ITEP Moscow)
I. Kerkhoff, R. Matthee (secretaries)

Registration, Contact & Info

Register and submit abstracts online at
<http://www.desy.de/agingworkshop>
Contact: aging_workshop@desy.de
Tel.: +49 40 8998-4800
FAX: +49 40 8998-4900

IEEE TRANSACTIONS ON NUCLEAR SCIENCE, VOL. 49, NO. 4, AUGUST 2002

1609

Summary and Outlook of the International Workshop on Aging Phenomena in Gaseous Detectors (DESY, Hamburg, October 2001)

M. Titov, M. Hohlmann, C. Padilla, and N. Tesch

1972: Degradation of MWPC: Classical Aging

NUCLEAR INSTRUMENTS AND METHODS 99 (1972) 279-284; © NORTH-HOLLAND PUBLISHING CO.

TIME DEGENERACY OF MULTIWIRE PROPORTIONAL CHAMBERS

G. CHARPAK, H. G. FISHER, C. R. GRUHN, A. MINTEN, F. SAULI and G. PLCH

CERN, Geneva, Switzerland

and

G. FLÜGGE

II. Institut für Experimentalphysik, Hamburg, Germany

Received 28 May 1971

The deterioration with time of multiwire proportional chambers using isobutane as one component of the gas mixture is studied. It is shown that by addition of methylal among others, a long

lifetime can be obtained without changing the properties of the gas mixture. Irradiation tests of $5 \times 10^{10}/\text{cm}^2$ have not shown any alteration in the chamber performance.

'Classical Aging Effects' lead to deposition of polymers on the anode (and/or) cathode surfaces and manifest as:

- Loss of gas gain and reduction of the plateau
- Loss of energy resolution
- Electron emission (Malter currents)
 - Sparking
- Self-sustained current discharge

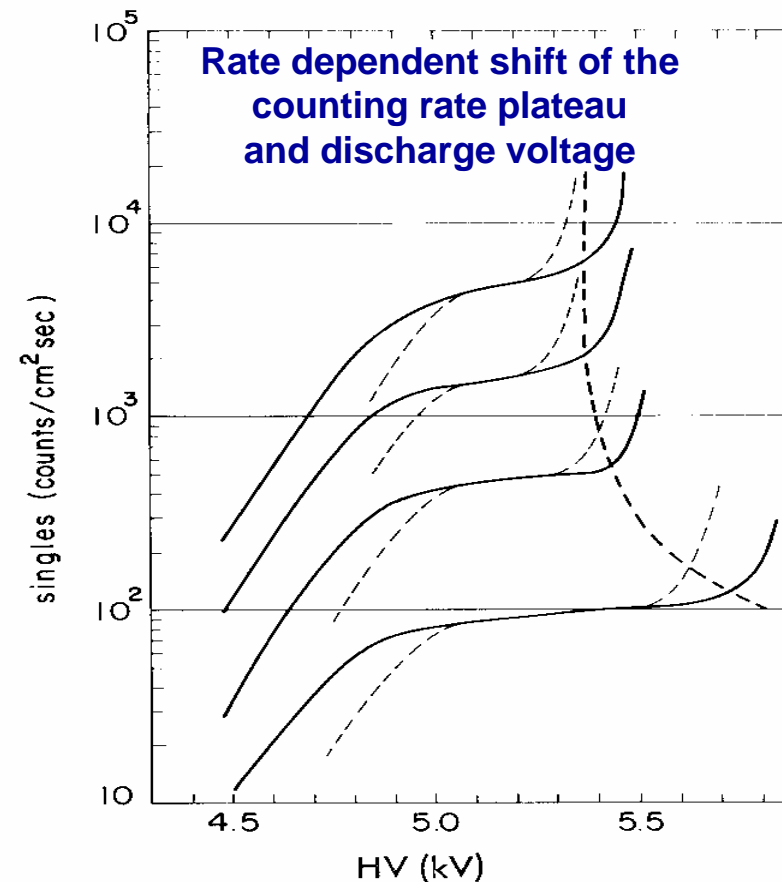

Mechanism of polymerization in wire chambers

During gaseous discharges many molecules break up due to collisions with electrons, de-excitation of atoms, and UV-absorption processes

Whereas most ionization processes require electron energies > 10 eV, the breaking of chemical bonds and formation of free radicals requires $\sim 3-4$ eV

Free-radical polymerization seems to be a dominating mechanism of the wire chamber aging

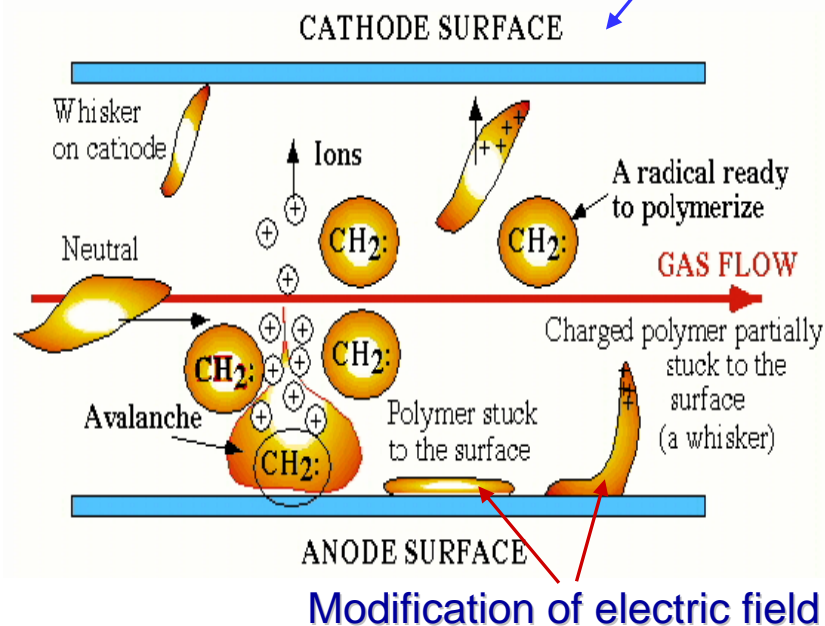

Polymer deposition mechanism (chemistry of gaseous discharges and nearby electrodes)

- Chemical reactions between polymer atoms and atoms of the electrode material
- Electrostatic attraction to the electrode (many chemical radicals are expected to have permanent or induced dipole moments)

Anode Wire Deposits

Solid whisker formation: J. Kadyk, NIMA300(1991) 436-479

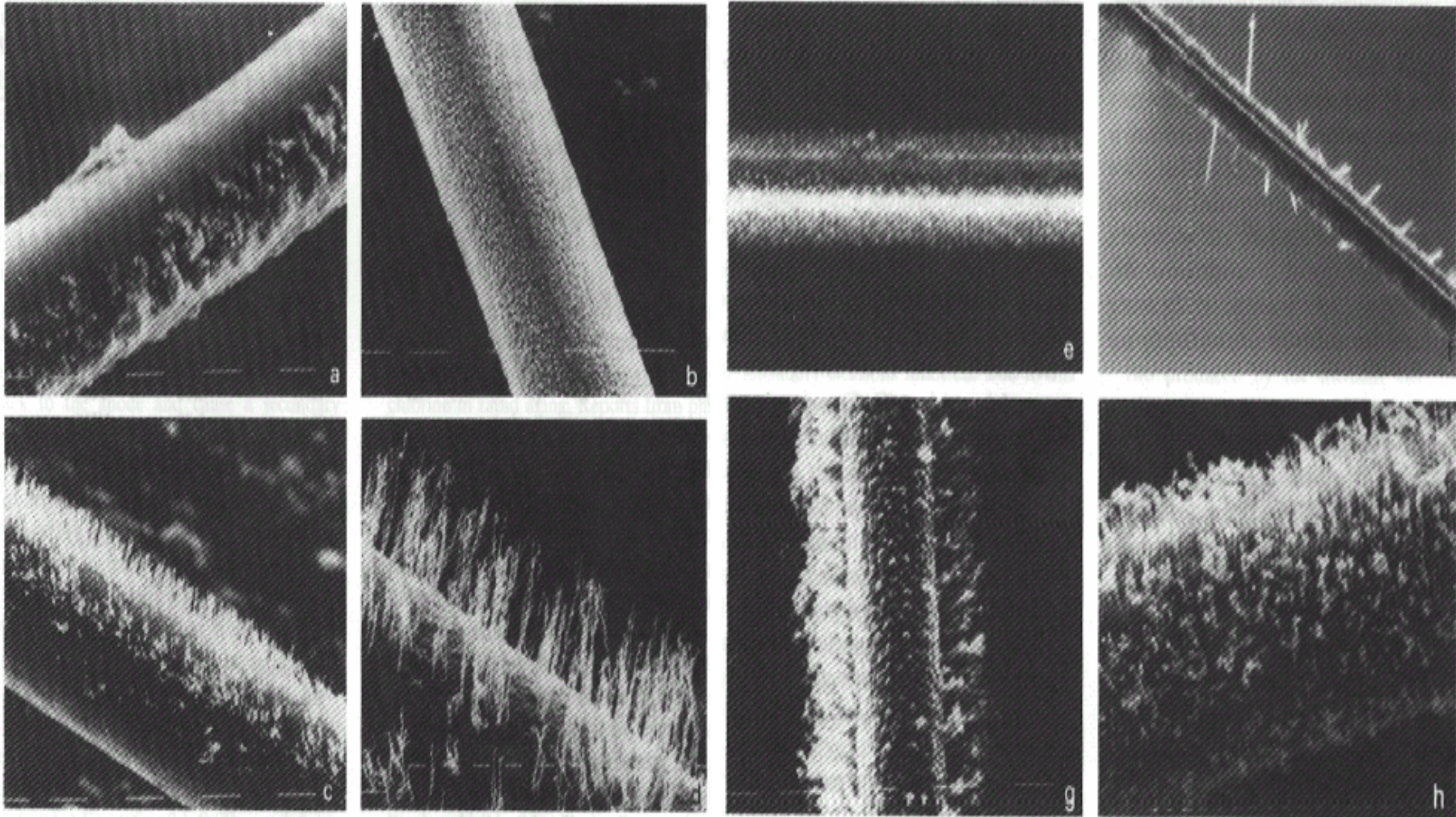

Wire Chamber vs Plasma Chemistry

There is too little overlap between plasma polymer physicists and gas detector physicists

Parameters are vastly different in two fields, BUT:

Parameter	Plasma Chemistry [1]	Wire Chambers
Average Electron Energy	1 – 10 eV	5 – 10 eV (Ar)
Effective Volume	100 – 1000 cm ³	10 ⁻¹⁰ – 10 ⁻⁸ cm ³
Typical Electron Density	10 ⁹ – 10 ¹² e/cm ³	10 ¹⁴ – 10 ¹⁷ e/cm ³ /avalanche
Typical Power Density	0.01 – 10 watts/cm ³	10 ⁸ – 10 ¹² watts/cm ³ /avalanche
Gas Pressure	0.01 – 10 Torr	≥ 760 Torr
E/p	10 – 50 V/cm·Torr	100 – 400 V/cm·Torr (on the surface of the anode)
Type of Electric Field	RF	DC
Typical Gas Flow	~ 1 Gas Volume/1-10 minutes	~ 1 Gas Volume/1-8 hours

Some qualitative conclusions from the plasma environment proved to be applicable to the wire chambers:

- Free radicals are the most likely active species involved into polymer formation
 - Most organic compounds with oxygen-containing groups (H₂O/ alcohols) are reluctant to form polymers
- CF₄-based gases can be used for both etching and deposition processes

It has to be stated, though,...

The absence of systematic studies in plasma chemistry with parameters similar to wire chambers (atmospheric pressure, power densities, gas mixtures) does not allow any quantitative comparisons between the plasma polymerization and wire chamber aging

Plasma Basics: Competitive Ablation and Polymerization

Both polymer-forming species and species that cause the ablation (etching) of materials are created in the plasma of the original monomer.

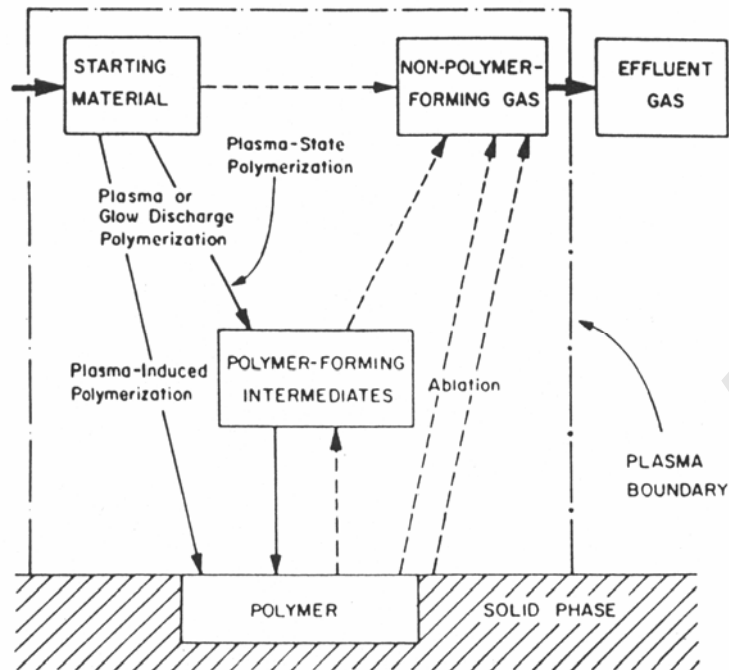

	Etching (Chemical)	Polymerization
Ar	0	-
O ₂	+++	-
H ₂ O	+	-
CO ₂	+	-
CH ₄	0	polymerize
CF ₄	+++	-
CF ₄ +H ₂	0 (HF)	polymerize
CF ₄ +CH ₄	0 (HF)	polymerize
CF ₄ +CO ₂	++	-

Perfluorocarbons represent the most extreme case of etching competing with polymer formation

Dominating mechanism vary with the types of gases and the discharge conditions

CF₄-based gases in plasmas are used for both etching and deposition processes, the distinction being made by the gas and its concentration with which CF₄ is mixed

Aging Phenomena in Gaseous Detectors

Implicit assumption: • aging rate is proportional only to the total accumulated charge

$$R = - (1/G)(dG/dQ) \quad (\% \text{ per C/cm}) \quad (\text{Kadyk'1985})$$

This model is not proven for high intensity environments

Aging phenomena depend on many highly correlated:

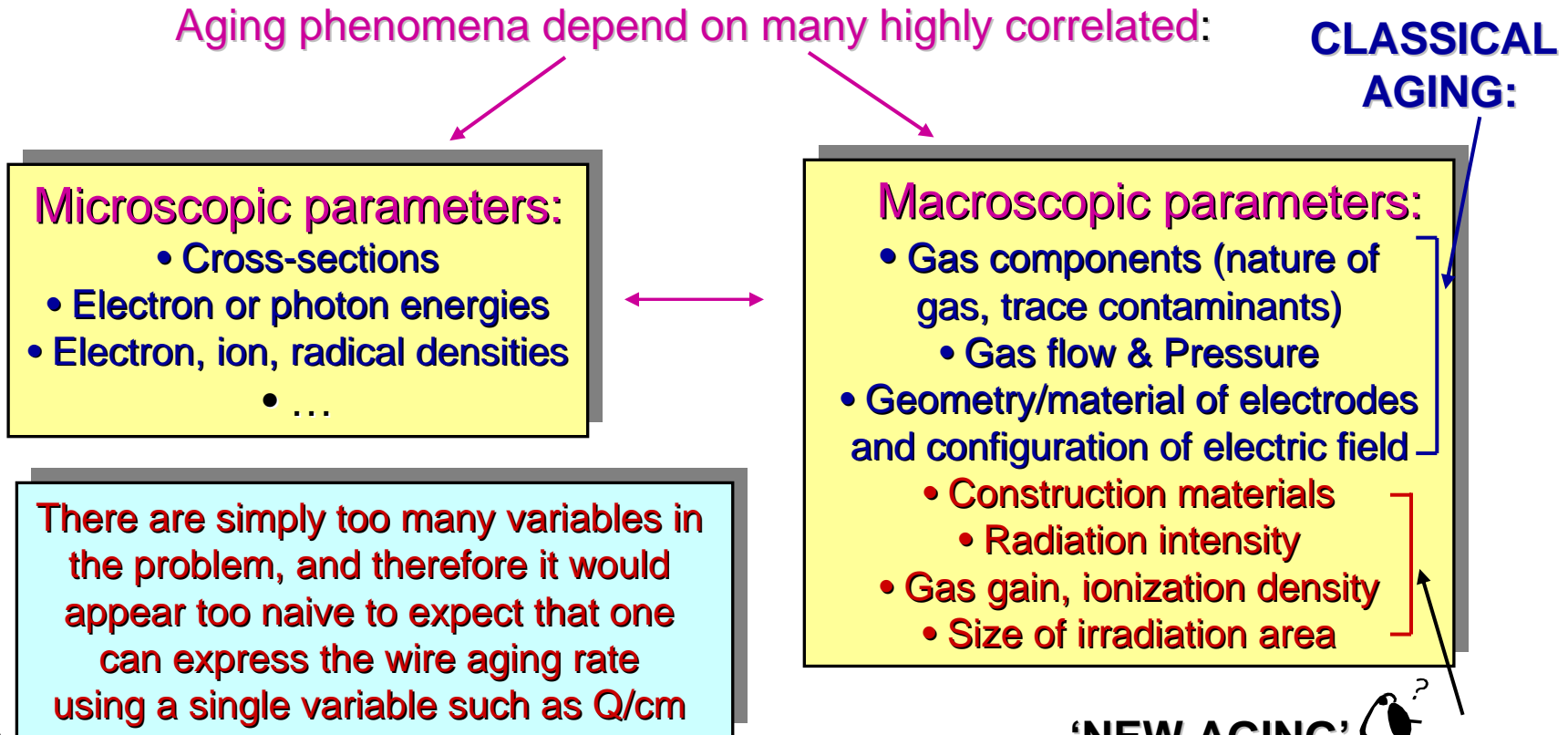

1. Classical Aging: Internal polymerization of hydrocarbons

- All hydrocarbons, including the simplest CH_4 , polymerize.
- Mechanism of CH_4 , C_2H_6 , ... polymerization is relatively well understood (hydrogen deficiency of radicals and their ability to form longer molecular chains)
- Pollutant molecules/trace contaminants may trigger and/or accelerate hydrocarbon polymerization

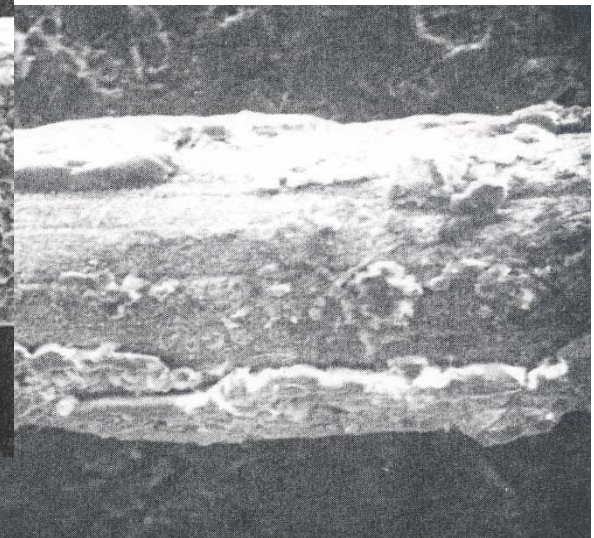
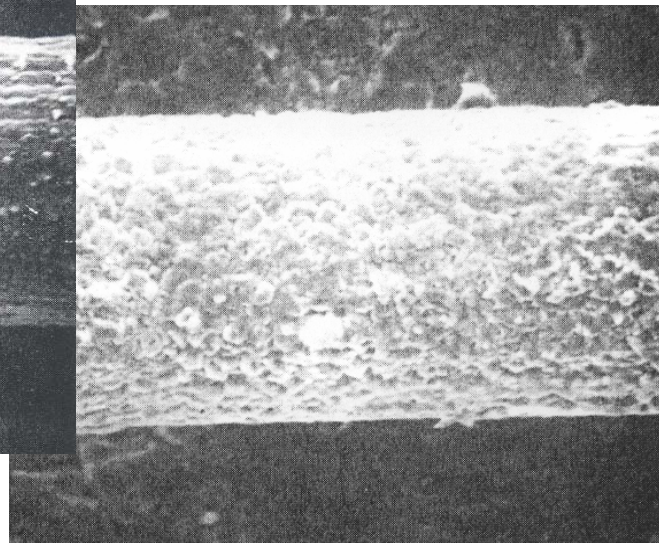
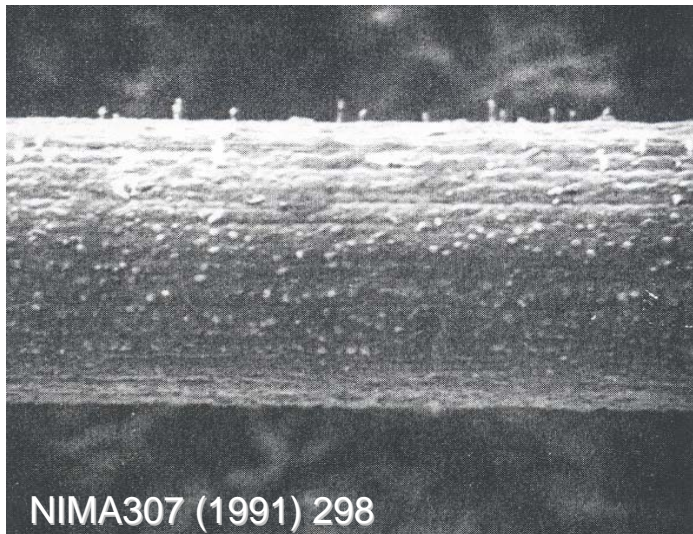
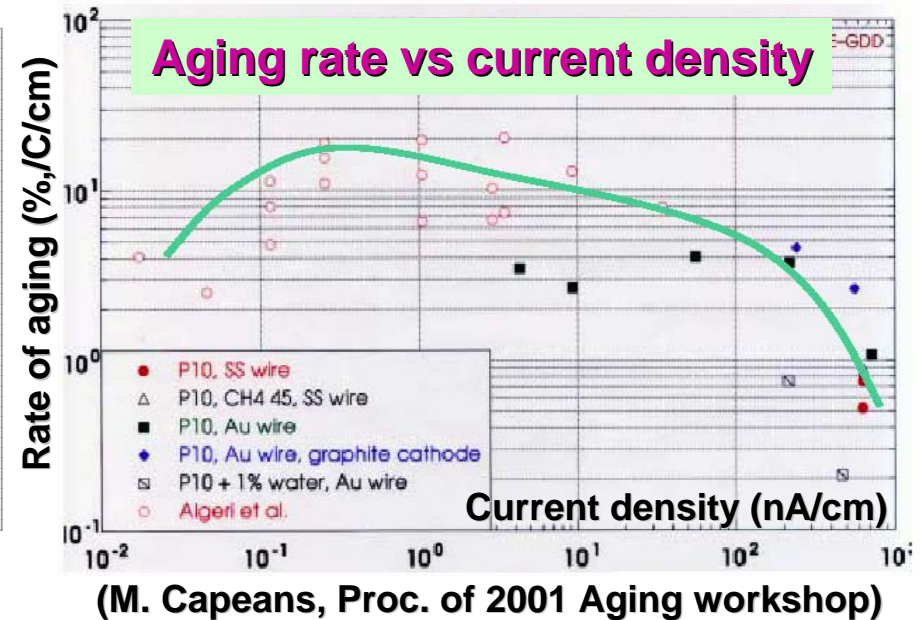

2. Classical Aging: Silicon contamination

The silicon contamination is one of the most serious problem for wire chambers

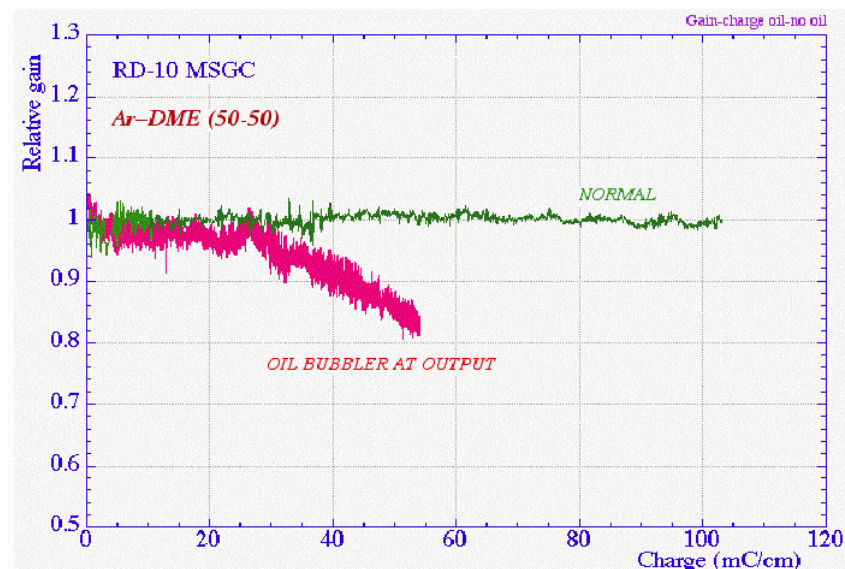

Example: "Vogtlin" flow regulator (rotameter) specially produced by company and claimed to be free from any lubricants (particularly Si-based).

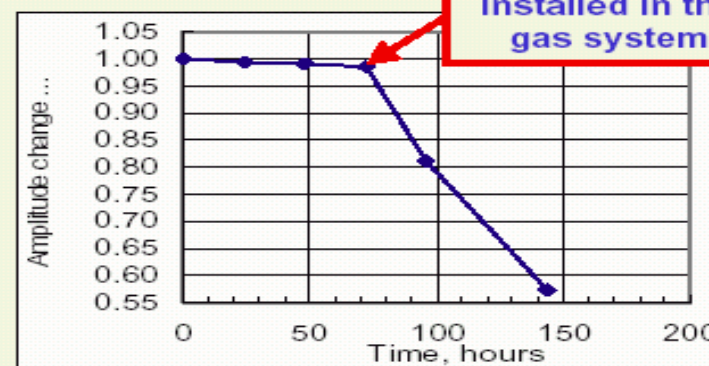

Examples of Si-based pollutants:

- Silicon rubber sealants and adhesives
- Silicon potting and encapsulation compounds
- Silicon vacuum grease (O-rings, mould-release agents) and various oils
- Detergent residues (sodium metasilicate)
- Glass and related products
- Fine dust, polluted gas cylinders, diffusion pumps, standard flow regulators, molecular sieves

If there is a question whether or not some device may incorporate Si, IT SHOULD BE SUBJECTED TO ADDITIONAL AGING TESTS

Si molecules should be avoided in the detector system at all cost

(J. Va'vra, NIMA252(1986)547; J. Kadyk NIMA300(1991) 436, M. Capeans, A. Romaniouk, F. Sauli, Proc. of 2001 Aging Workshop)



2. Classical Aging: Silicon Contamination

Silicon has been systematically detected in analysis of many wire deposits, although in many cases the source of Si-pollutant has not been clearly identified

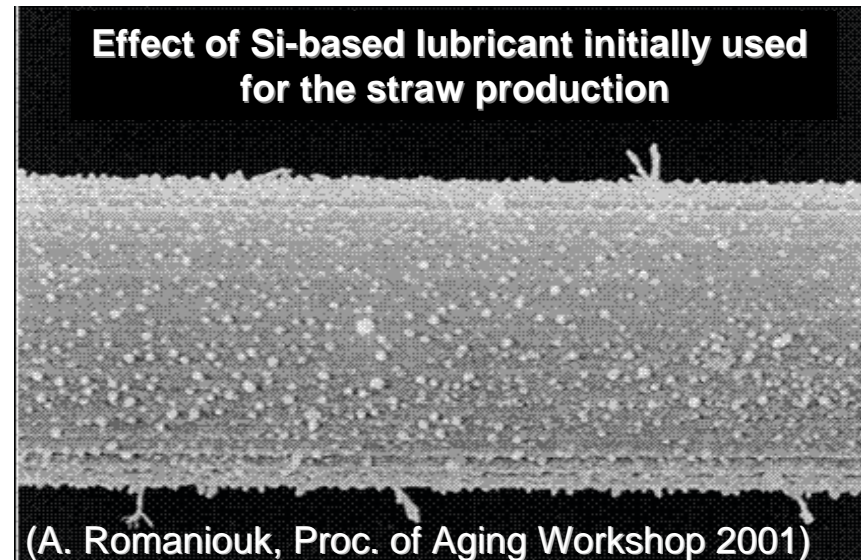
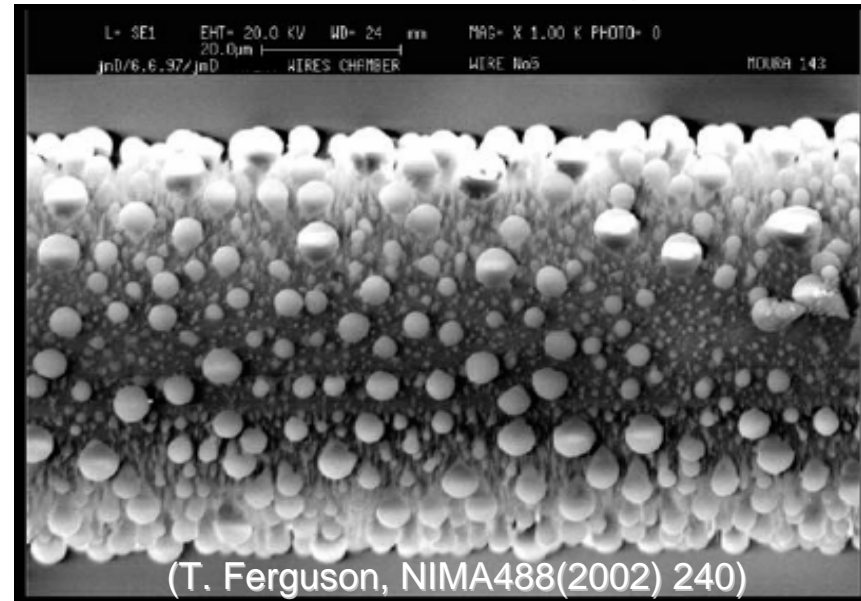
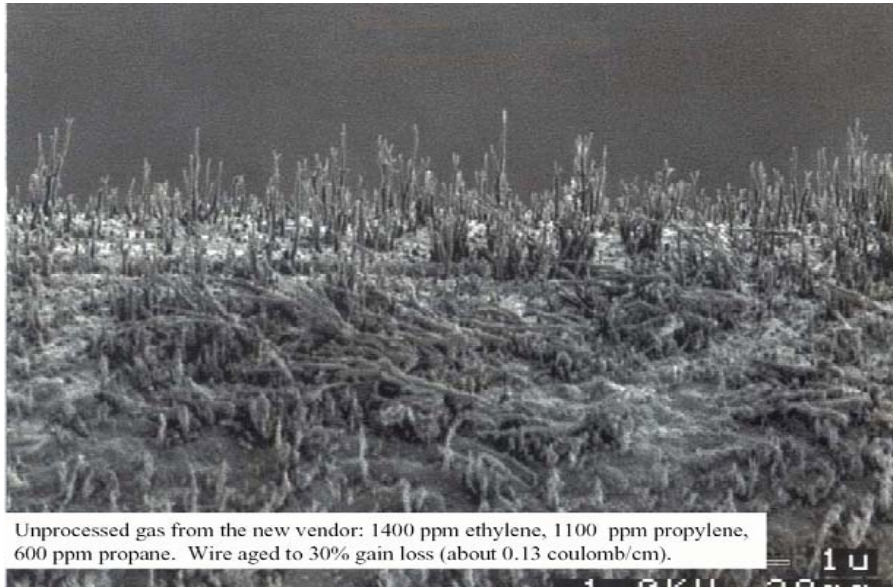

3. Classical Aging: Malter Effect

- Malter effect is induced by insulating deposits on the cathode

Ions which are not neutralized at the cathode

↓
Large electric field across the insulating layer

↓
Electrons are 'pulled out' from the cathode

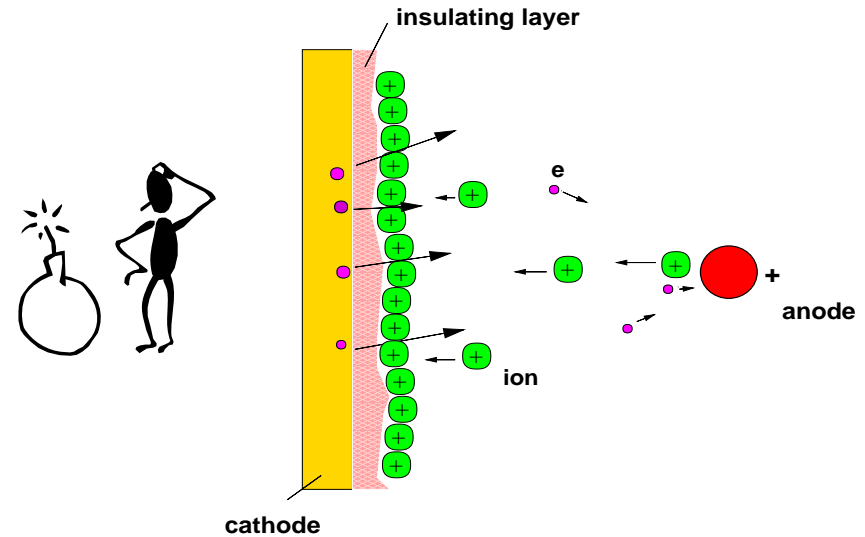

The microscopic non-conductive layer on the cathode will impede the ion flow (appearance of the dark current), in some cases it can lead to classical Malter effect (exponential current growth)

The RICH-GRID Detector
(First imaging of Malter effect):
sporadic bursts of single electrons
from a localized cathode spot.
J. Va'vra – NIMA367(1995) 353

Factors which facilitate an ignition:

- Poor cathode conductivity and/or microscopic dielectric insertions
- Highly ionizing particles, sparks, discharges

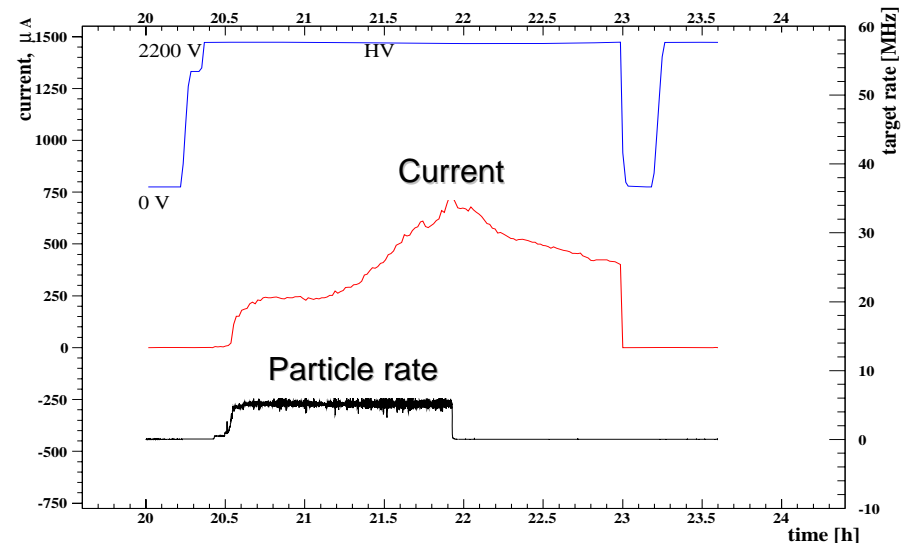

Recent experience with large area gas detectors

Radiation levels not even thought in '1980: (from mC/cm → many C/cm)

'Low & standard radiation levels' (LEP, HERA ep, BaBar, Belle, CDF, D0...)

- Basic rules for construction are known and tested
- Detectors are built and demonstrated to work
- Huge variety of gases are used
- If aging is nevertheless observed :
add oxygen-containing additives
(to suppress CH₄ polymerization/Malter effect)
(and/or) having identified the source of pollution, try to clean the gas system

'High radiation levels' (LHC, HERA-B,...)

- Enormous R&D done
(RD-10, RD-28, RD-6, HERA-B, ATLAS, CMS, LHC-b, ALICE, ...)
- Some basic rules are found
- List of clearly 'bad' materials
- Left only with a few gases
- New classes of gas detectors - MSGC, MPGD, straws, CsI, RPC with their own specific aging effects have evolved

Final proof of the large detector systems still to come

Aging Experience with High-Rate Detectors of the LHC era

(Micro-Pattern Gas Detectors, HERA-B, LHC)

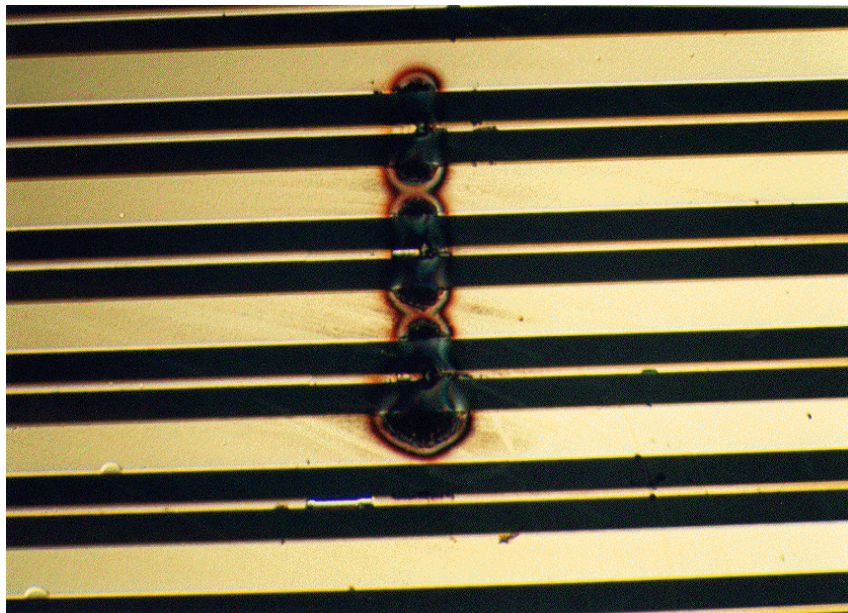

FULL BREAKDOWN in MSGC

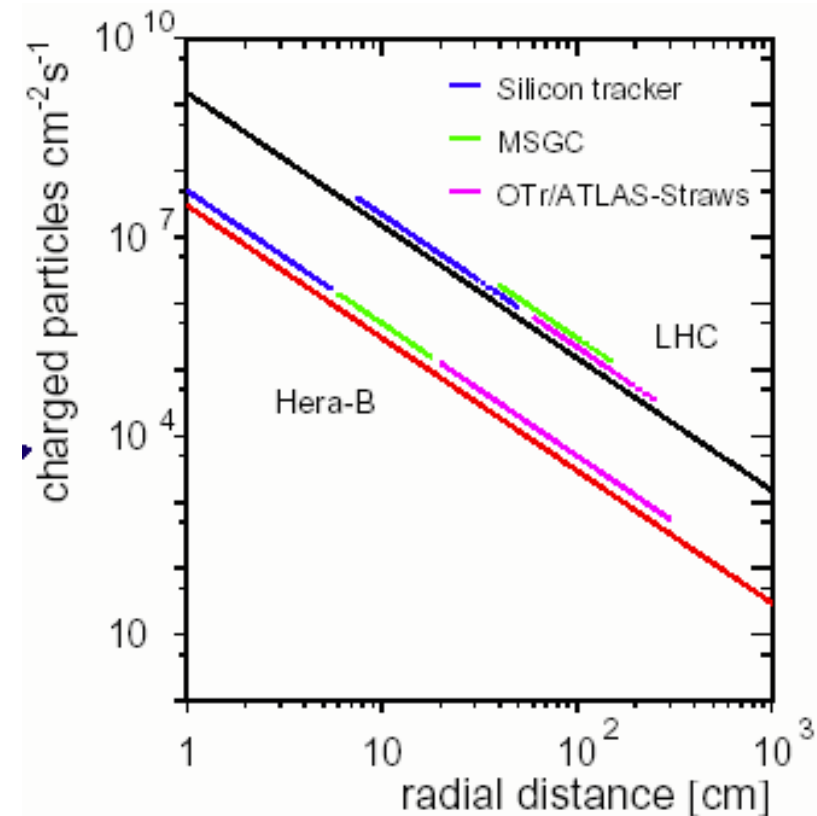

Micro-Strip Gas Chambers: findings and solutions (I)



The lifetime studies of Micro-Strip Gas Chambers (MSGC) in high intensity environments, which had also the greatest impact on the understanding of aging phenomena in all the types of gaseous detectors, demonstrate that the amount of pollutants in the gas system plays a major role in determining the aging properties of the detector; outgassing from materials, epoxies, joints, tubing has to be carefully controlled and kept at ppm level or better

MSGC has entered a new dimension of sensitivity compared to MWPC mainly due to the filigree nature of the MSGC structure and catalytic effects on the MSGC substrate

RD28: aging results from MSGC community

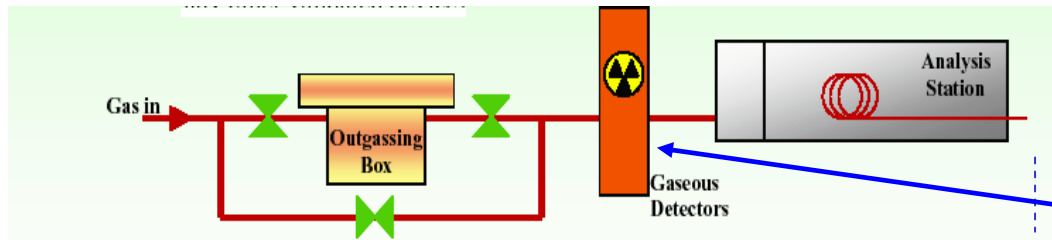

(R. Bouclier et al., NIMA381(1996) 289,
M. Capeans, ICFA Instrum. Bull.24(2002)85-109)

(NASA DATABASE - Outgassing Data for selecting
Spacecraft Materials
<http://epims.gsfc.nasa.gov/og/index.cgi>)

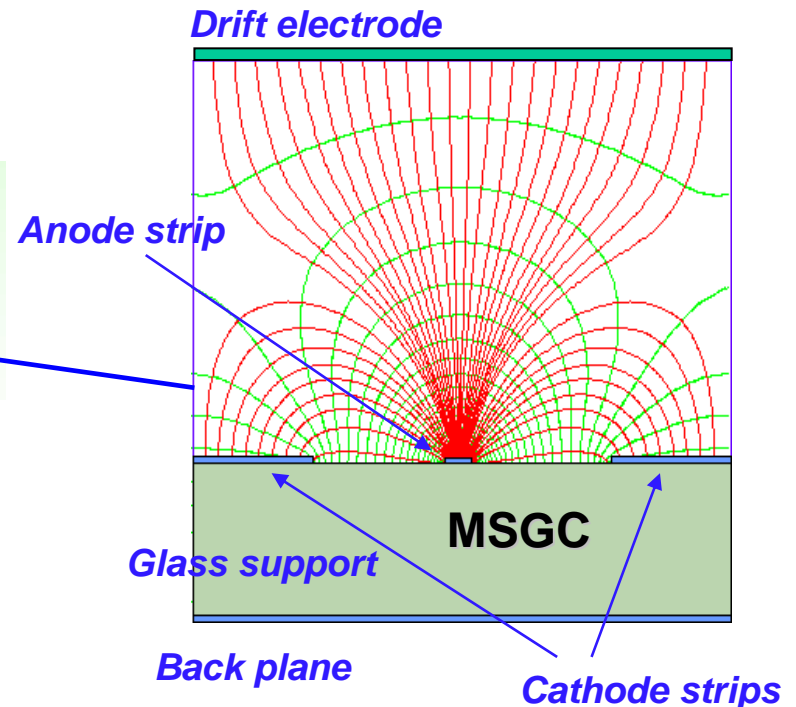

Micro-Strip Gas Chambers: findings and solutions (II)

Guidelines for construction and operation of

Classical Wire chambers at low rates:

- 'Moderate' clean environment and cleaning procedures during detector construction, use of well tested 'old good materials'
- Prior to start of operation, cleaning of the gas mixing and distribution system
 - Avoid the well known 'bad molecules' in contact with active gas (Si, halogens, plasticizers, phthalats, PVC, epoxy outgassing)
 - Huge variety of gases can be used (noble gases, hydrocarbons, CO₂, CF₄, C₂H₂F₄, H₂O, alcohol, magic gas,...)
DME is reasonably radiation hard, but aging in DME is highly sensitive to traces of pollutants, evidence of DME damaging materials

Micro-Strip Gas Chambers:

- Many non-metallic 'old good materials' might nevertheless outgas at a small level, causing fast aging under high rates
- The use of ultra clean gas systems, detector components, adequate assembly procedures and strict quality tests is mandatory
- There are clearly many 'bad' and a lot of 'usable' materials
A material is adequate or not for a very particular detector type and operating conditions test to match specific requirements
- Gas mixtures of Ar or Ne diluted with CO₂ or DME are favorite candidates
To prevent fast aging at high rates avoid the use of hydrocarbons

Micro-Strip Gas Chambers: findings and solutions (III)

Major processes leading at high rates to operating instabilities of MSGC:
 substrate charging up, surface deposition of polymers and microdischarges



• Borosilicate glass results in rate-dependent modification of gain due to a radiation induced variation of surface resistivity

Stability of the mandatory MSGC surface resistivity at high rates can be achieved with 'diamond-like coating' of the glass (no gain reduction up to 80 mC/cm irradiating with X-rays, 10 HERA-B years)

NO discharges with X-rays and electrons
Discharges with α -source and in HERA-B
 (discharge rate ~ many per min)

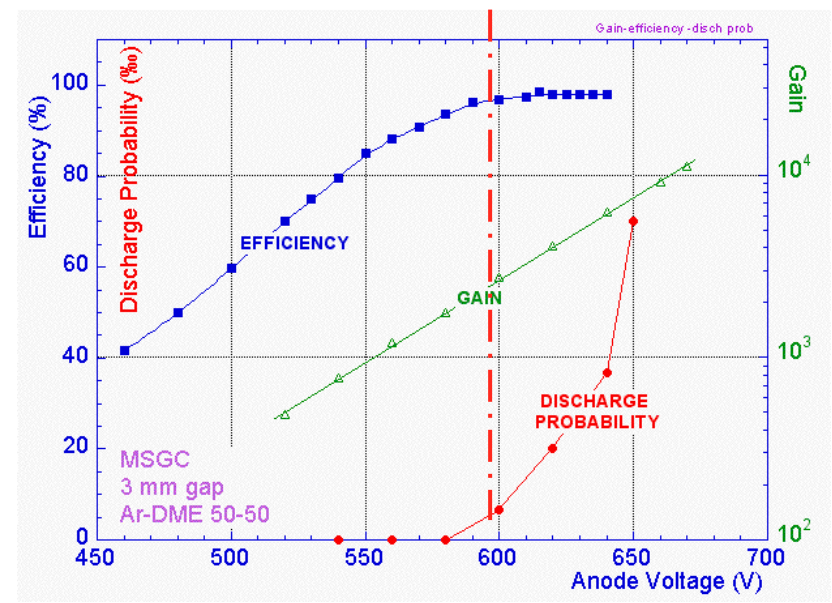
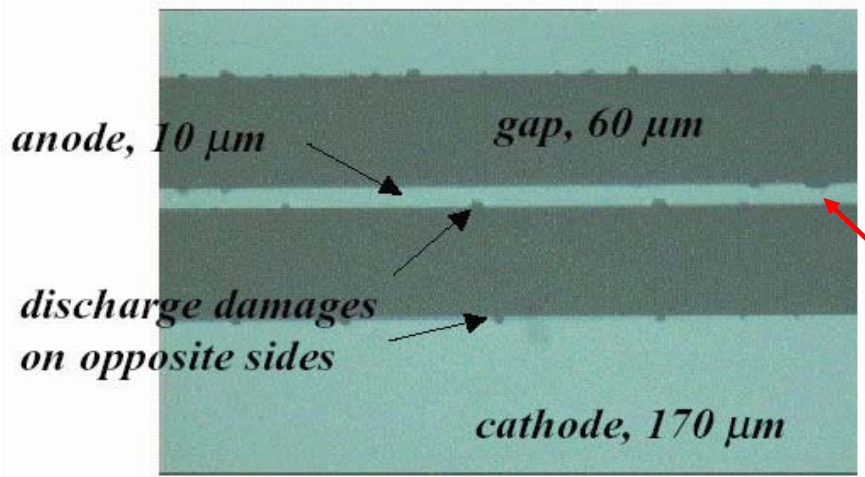

Induced discharges are intrinsic problem of the MSGC principle
 (no gains >2000 in hadronic beams)

(R. Bouclier et al., NIMA381(1996) 289, F. Sauli, NIMA477(2002) 1.)

Micro-Strip Gas Chambers: findings and solutions (IV)

The influence of the MSGC strip material:

Aluminum electrodes are more robust against gas discharges than gold

- 'Bubbles' or 'creates' on Al cathode strips
- No damage with gold strips

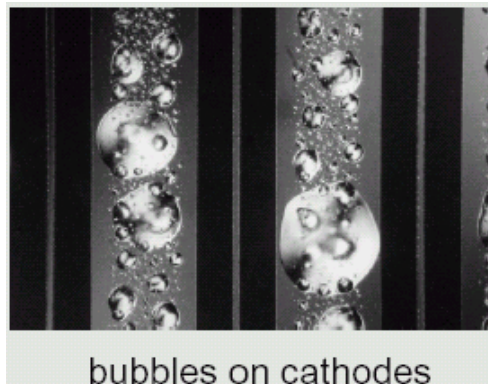

Ar/CO₂ (70:30)
2.7 mC/cm

Ar/DME(50:50)
+ 0.3% H₂O
0.8 mC/cm

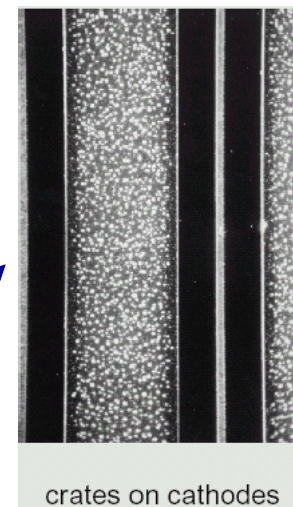

Influence of water content in MSGC:

Increased running stability but severe anode aging in Ar/CO₂ and Ar/DME (0.3% H₂O)

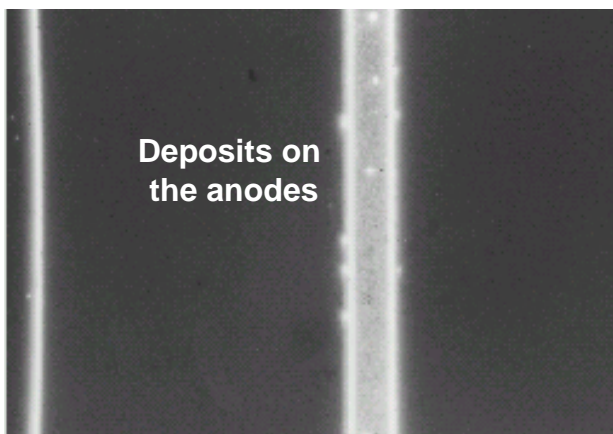

Two stage multiplication is necessary MSGC + GEM (F. Sauli)

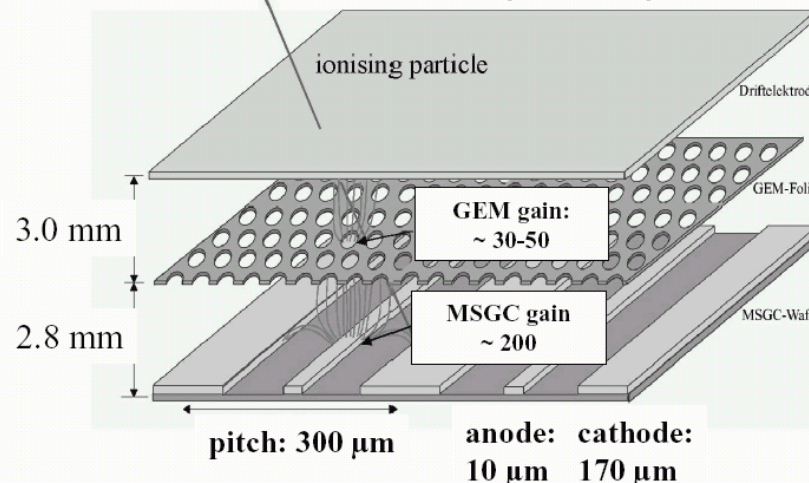

Radiation damage and long-term behavior of MSGC-GEM

Many tests with Ar/DME:

No degradation of performance in small-scale aging tests at Purdue up to 220 mC/cm

(Nucl. Phys. B 78(1999), 695-702)

MSGC+GEM prototype for HERA-B Inner Tracker:

- Fast aging under X-rays, when size of the irradiated area is large enough (deposits are not limited to the irradiated area)
- Identical chambers with Ar/CO₂ showed no aging

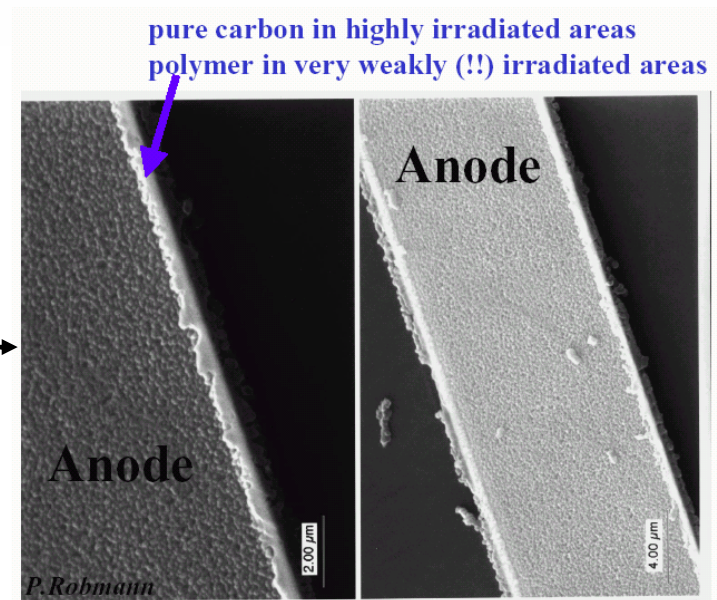
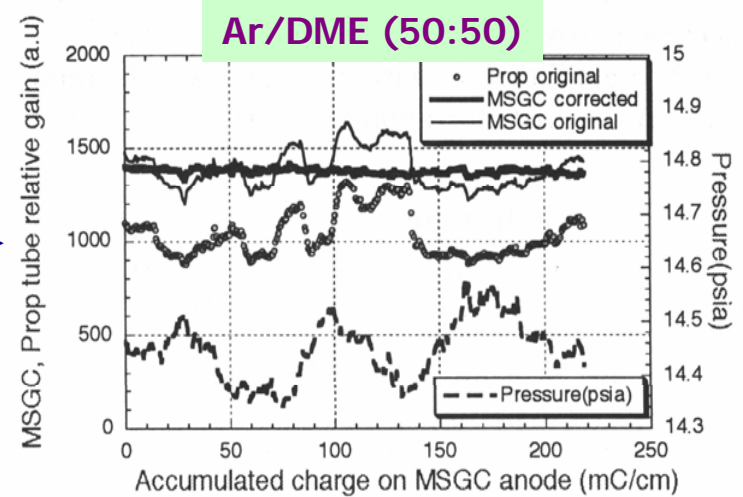
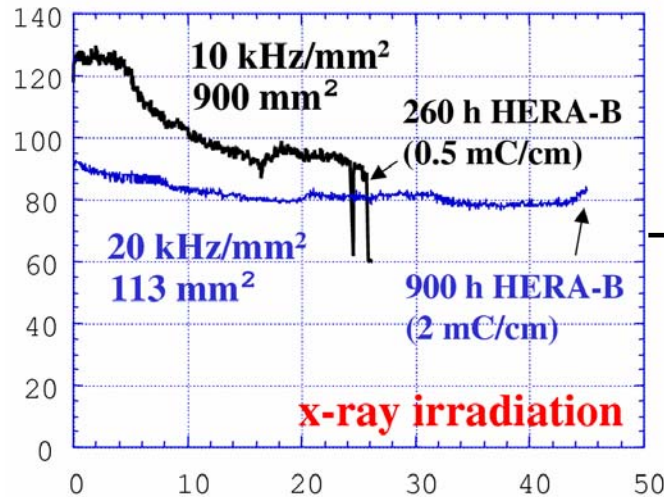

Gas Aging Effects strongly depend on the size of the irradiated area

Experience with Large MSGC-GEM Detectors at High Rates

MSGC-GEM Detector for HERA-B Inner Tracker:

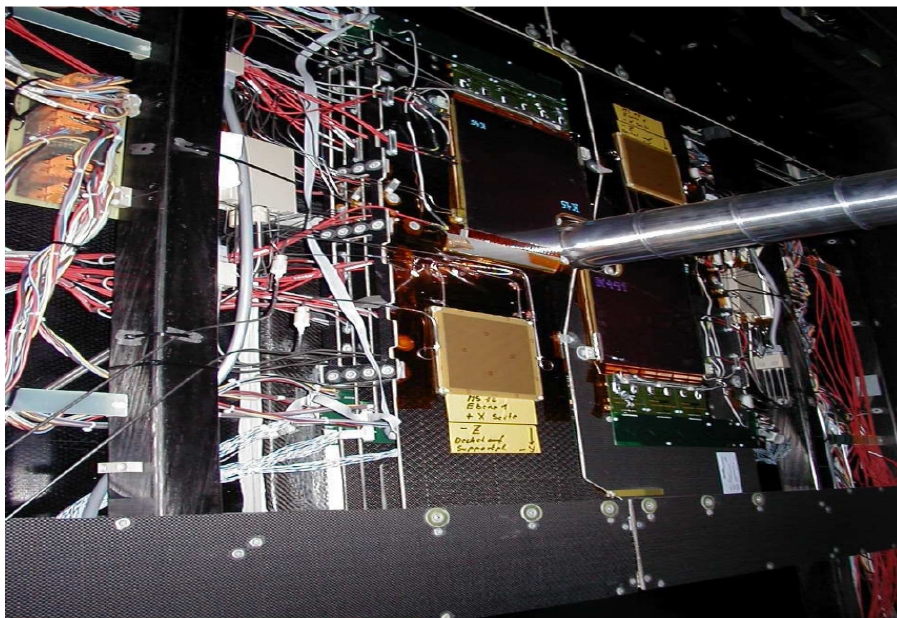

Reliable operation without major problems
Detector size: 25*25 cm²; Gas: Ar/CO₂(70:30)
Sparking rate: <~ 2 sparks/chamber/day

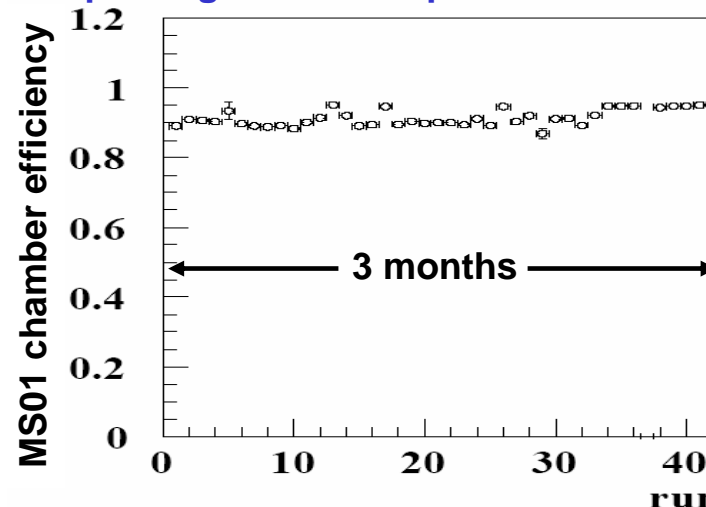

T. Zeuner, Yu. Gorbunov, private communication

MSGC-GEM Detector for DIRAC experiment at CERN:

The experiment run for 4 years at high intensities collecting in the hottest region 1 mC/cm² with efficiency decreasing from 95 to 85 % in worst case.

Substrate: DESAG D263
Detector size: 10*10 cm²; Gas: Ar/DME (60:40)
Particle flux: 3*10³ particles/mm²
Trip rate: 1-3 per day

F. Sauli, F. Gomez, private communication

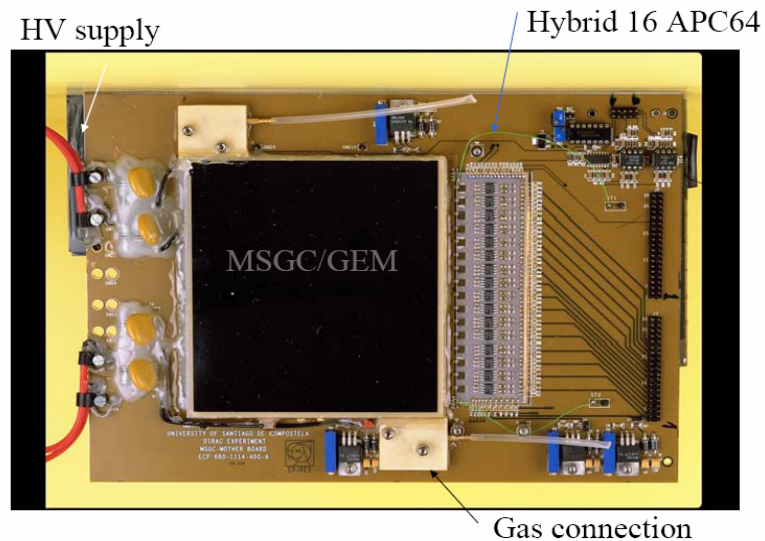

Aging studies with Micro-Pattern Gas Detectors

MICROMEAS resembles one side GEM

(parallel plate multiplication in thin gaps between a fine mesh and anode plate)

Whilst frequently discharging in harsh beam conditions, detectors have been demonstrated not to suffer permanent damages

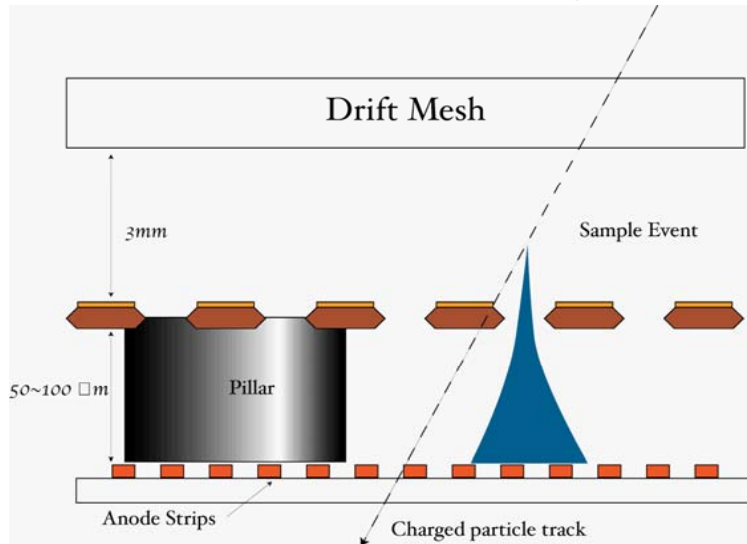

- Stable gain in MICROMEAS up to 18 mC/mm² in Ar/iC₄H₁₀ (94:6) (A. Delbart et al., NIMA478(2002) 205)
- COMPASS MICROMEAS operate with Ne/C₂H₆/CF₄ (79:10:11)

MICROMEAS + GEM

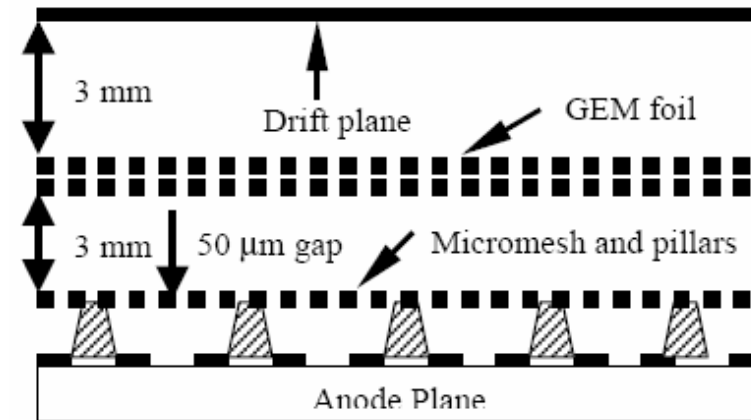

- No degradation in MICROMEAS + GEM up to 23 mC/mm² in Ar/CO₂ (70:30) (S. Kane et al., Proc. of 2001 Aging workshop)

MICROMEAS TPC for LC

- No gain deterioration after 2 mC/mm² in Ar/CF₄(95:5) (P. Colas, Saint Malo, Apr. 13 (2002))

Compatibility of CF₄ and MPGD structure:

- CF₄ etching of DLC in MSGC (ICFA Instrum. Bull. 24(2002) 54-84)
- CF₄ etching of copper surfaces (physics/0308047)

Aging of Double-GEM + PCB

Separation of amplifying device (GEM) and the charge collector (PCB) minimizes the aging

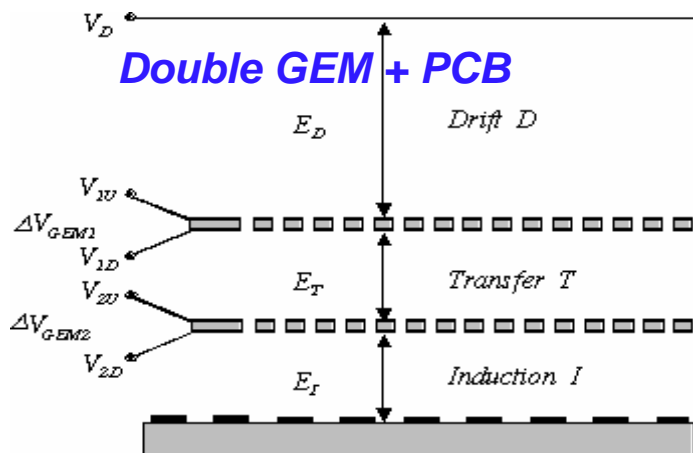

Slight gain loss in double GEM+PCB at Purdue 25 mC/mm²

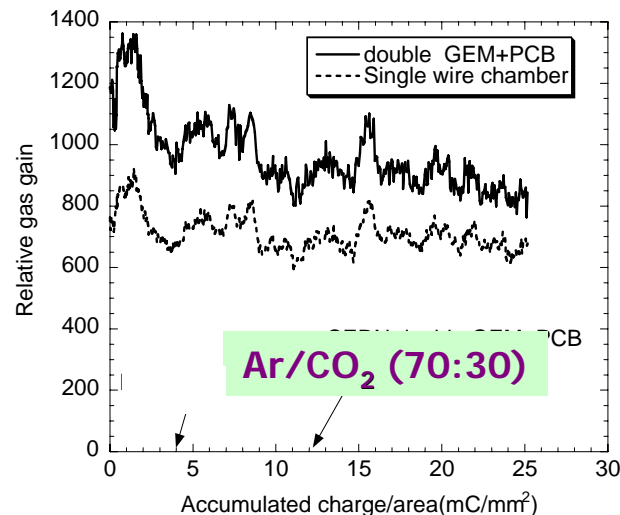

J.Miyamoto et al., 2000 IEEE NSS,Lyon

- Lower electrode of the second GEM (close to the PCB) aged more than the others (no change of PCB appearance)

- Triple GEM could circumvent the moderate aging in double GEM

No gain loss in double GEM+PCB at CERN 12 mC/mm²

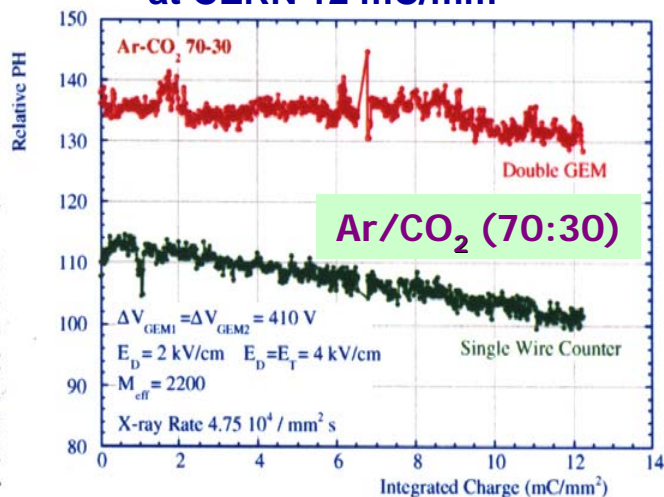

Fig. 3: Long-term gain stability under irradiation. A single-wire counter in the same gas line shows aging.

S. Bachmann et al., 1999 IEEE NSS, Seattle

C. Buttner et al, NIMA 409(1998)79, S. Bachmann et al, NIMA 443(1999)464

Aging of Triple-GEM + PCB

No gain loss in large area triple GEM+PCB for COMPASS at CERN up to 7 mC/mm²

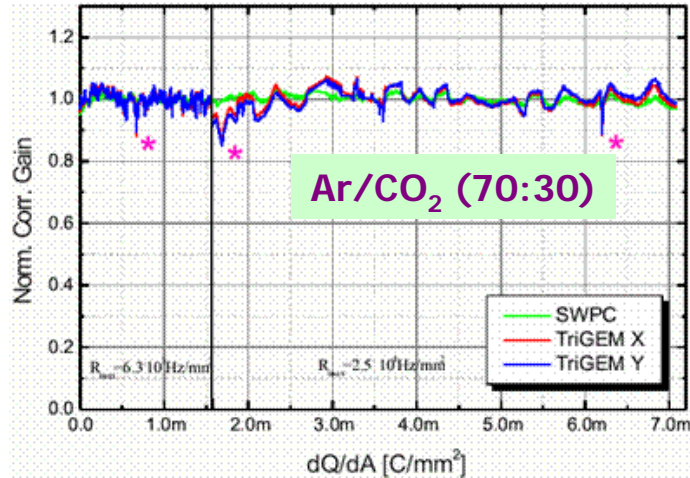

M. Altunbas et al., CERN-EP/2001-091

No visible aging effects in triple GEM+PCB at Purdue 27 mC/mm²

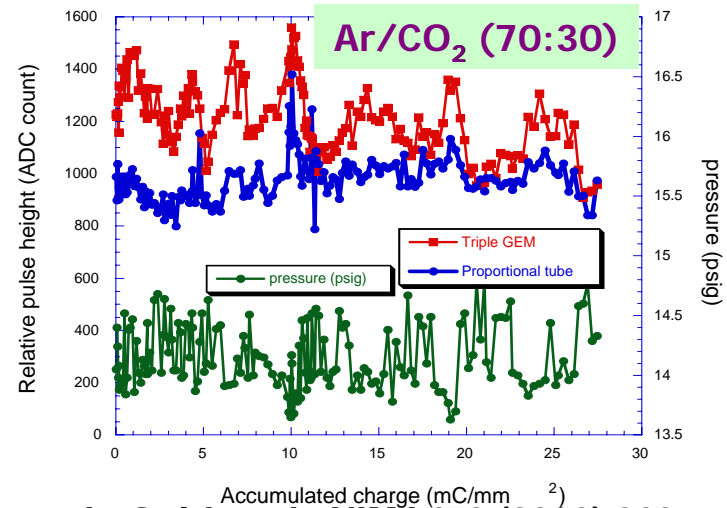

L. Guirl et al., NIMA478 (2002) 263.

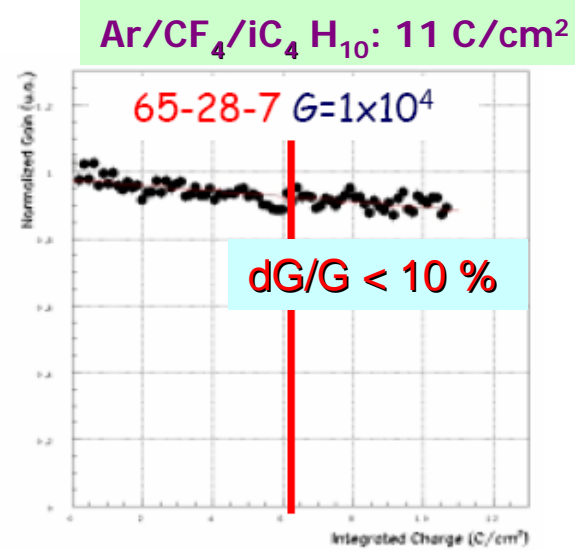
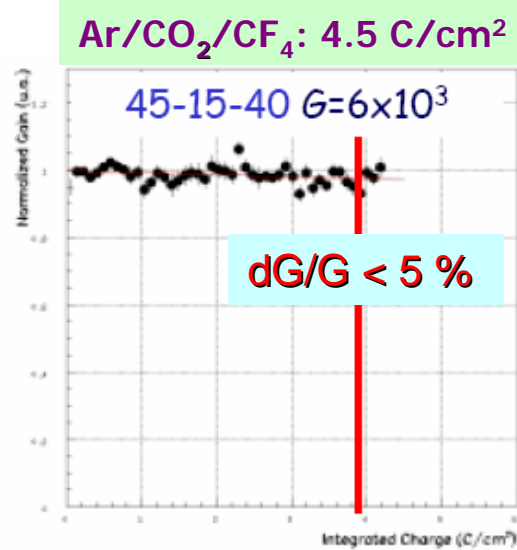
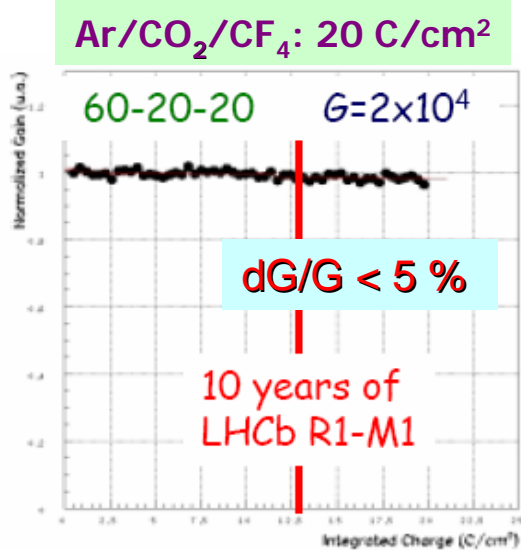

F. Murtas, Frascati, Nov. 28(2002)

Summary of Aging Experience with Micro-Pattern Gas Detectors

- Micropattern detectors filled the gap between wire chambers and solid state devices
- Induced discharges are intrinsic property of all single stage micropattern detectors in hadronic beams (MSGC turned out to be prone to irreversible damages)
- More robust devices (MICROMEGAS, multi-GEM) can tolerate certain sparking rate and better suited for the harsh environments than MSGC based systems (stable MPGD operation requires extremely low levels of water)
 - MSGC are much more susceptible to age than wire chambers (possibly because of a small effective area used for charge multiplication)
- New micro-pattern detector concepts (MICROMEGAS, GEM) are rather insensitive to aging compared to micro-strip structures (separation of multiplication and readout stages, lacking fragile thin anodes, gain being obtained by avalanche multiplication along an extended high field region)

If properly designed and constructed, these detectors can be robust and stable in presence of high rates and heavily ionizing particles

- Large area triple GEM (31*31 cm²) and MICROMEGAS (40*40 cm²) detectors are currently running successfully in the COMPASS experiment during 1 year; triple GEM were also proposed for the central region of the LHC-b muon system

CF₄-based mixtures in gaseous detectors

1979: CF₄ is proposed as the most attractive candidate for high-rate environments.

Among the currently available gases CF₄ has the largest drift velocity.

Currently used/planned in large area gas detectors: HERA-B/OTR, HERA-B Muon, COMPASS straws, ATLAS/CSC, CMS/CSC, LHC-B Tracker, LHC-B Muon,...

1990-2000: CF₄ is considered to be used as a radiator gas for the hadron blind detectors (HBD), the drift gas for the TPC, the working gas for GEM and for GEM-based gaseous photomultipliers

Attractive properties:

- 1) Very high drift velocity (>10cm/μs)
- 2) Low electron diffusion
- 3) High primary ionization
- 4) No CF₄ free mixtures are able to tolerate doses ~ 10 C/cm
- 5) CF₄ have ability to suppress strongly Si-polymerization
- 6) CF₄ dissociative products able to etch wire deposits created in Ar/C₂H₆ (50:50) and Ar/CF₄/CH₄ (74:20:6)

Disadvantages:

- 1) Large cost (implies gas recirculation for large systems)
- 2) Large electron attachment
- 3) Evidence of production of long-lived and highly electronegative F-based radicals
- 4) CF₄ avalanches produce hard photons secondary effects on nearby electrodes
- 5) Etching of detector materials
- 6) Fluorine creates non-conducting metal fluorides on non gold-plated electrodes
- 7) Anode and cathode aging effects were observed in CF₄/hydrocarbon mixtures

Aging Studies for the HERA-B Outer Tracker

Honeycomb Drift Chambers with carbon-loaded polycarbonate foil (Pokalon-C) used as a cathode:

X-rays setup:
 Small area honeycomb chambers had shown no aging effects up to 4.5 C/cm of integrated radiation dose

HERA-B high-rate environment:
 Persistent Malter currents in full size prototype honeycomb chambers after ~ 0.5 mC/cm of accumulated charge

Facility Radiation Type	Radiation Density	Radiation Density	Irradiation area	Gas Mixture	Effect seen?
Zeuthen X-Ray Mo (35 keV)	5 C/cm	1.5 μ A/cm	~1x3 cm ²	CF ₄ /CH ₄	NO*
Dubna X-Ray Cu (8 keV)	6 C/cm	5 μ A/cm	~0.5x1 cm ²	Ar/CF ₄ /CO ₂	NO*
HMI Electron 2.5 MeV	10 mC/cm	0.1-3 μ A/cm	~100x 30 cm ²	Ar/CF ₄ /CH ₄	NO*
HD X-Ray Cu (8 keV)	~ mC/cm	~0.1 μ A/cm	~46x 30 cm ²	Ar/CF ₄ /CH ₄	NO*

Very fast anode aging observed

X-rays or e⁻ can not trigger Malter effect independently of their energy or radiation intensity

Facility Radiation Type	Radiation Density	Radiation Density	Irradiation area	Gas Mixture	Effect seen?
Rossendorf Protons 13 MeV/c	5 mC/cm	0.3 μ A/cm	~9x9 cm ²	Ar/CF ₄ /CH ₄	NO
Rossendorf α -part, 28 MeV/c	3 mC/cm	0.6 μ A/cm	~1x3 cm ²	Ar/CF ₄ /CH ₄	NO
PSI p 70 MeV/c	~ mC/cm	0.2 μ A/cm	~0.5x0.5 cm ²	Ar/CF ₄ /CH ₄	NO YES*
PSI π /p 350 MeV/c	~ mC/cm	0.02 μ A/cm	~12x22 cm ²	CF ₄ /CH ₄	YES
Karlsruhe α -part, 100 MeV/c	~ mC/cm	0.02 μ A/cm	~7x7 cm ²	Ar/CF ₄ /CH ₄	YES
HERA-B P(920 GeV)-N	~ mC/cm	0.03 μ A/cm	100x30 cm ²	All gas mixtures	YES

Hadrons above certain energy produce Malter effect at ~mC/cm as in HERA-B (Irradiation area above certain limit is necessary for ignition of Malter effect)

Strong Aging dependence on particle type and energy

Aging Studies for the HERA-B Outer Tracker

Intense R&D program:

All building materials (glues, plastics, wires) and technique were tested and validated: use only 'allowed' construction materials and gases, carefully check the way detectors are built

Chamber would not operate in HERA-B longer than 10 hours

- Indications that the pokalon-C is responsible for Malter effect and impede the ion flow at high rates

- Fast anode aging is due to Ar/CF₄/CH₄ (74:20:6)

Stable gain for more than 2 HERA-B years (~ 1C/cm)

- Coat 1200 foils with 40 nm Cu (good adhesion to plastics)+ 40 nm Au (gas contact)

- Change to Ar/CF₄/CO₂(65:30:5)

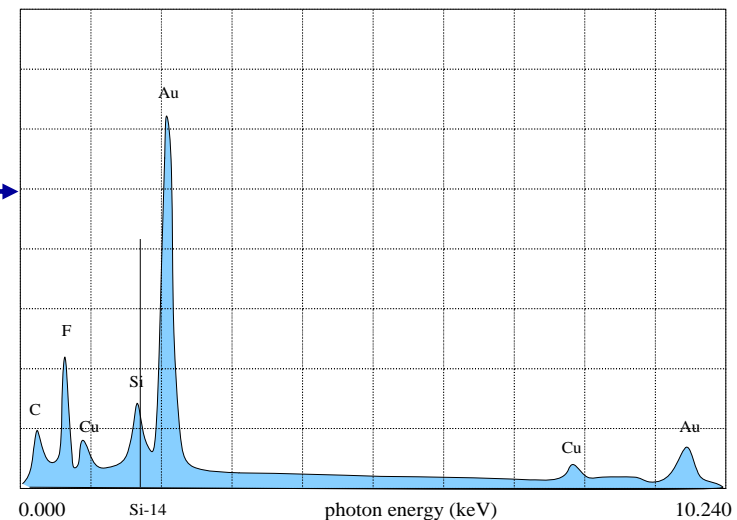
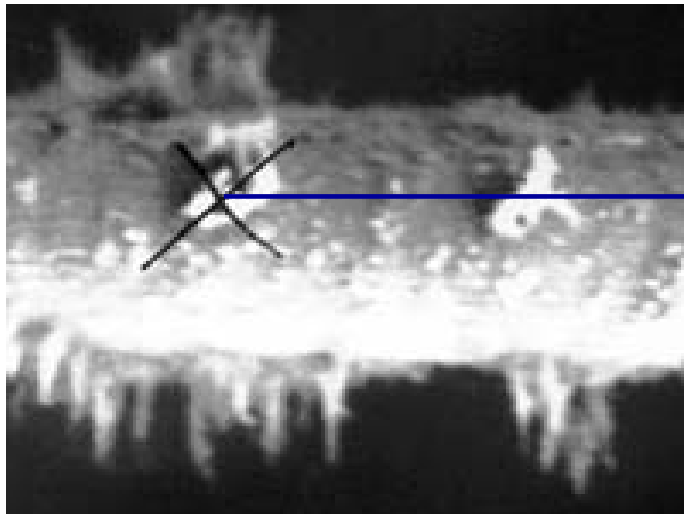

Aging Studies for the HERA-B Muon Detector

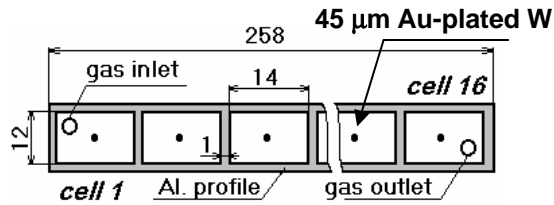

100 MeV α -beam ($8 * 8 \text{ cm}^2$)

Ar/CF₄/CH₄(74:20:6)
Gain reduction after 60 mC/cm:

Laboratory tests:
Fe⁵⁵ and Ru¹⁰⁶ sources

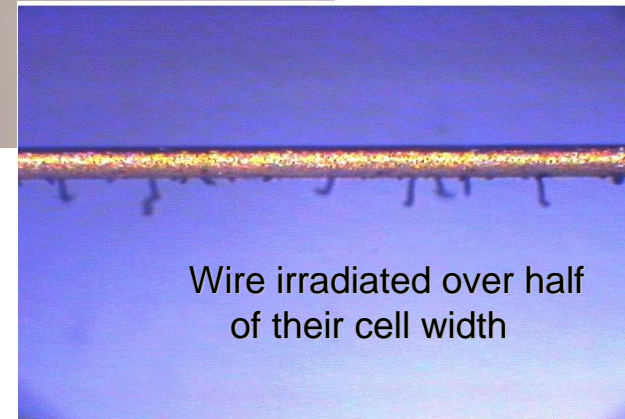
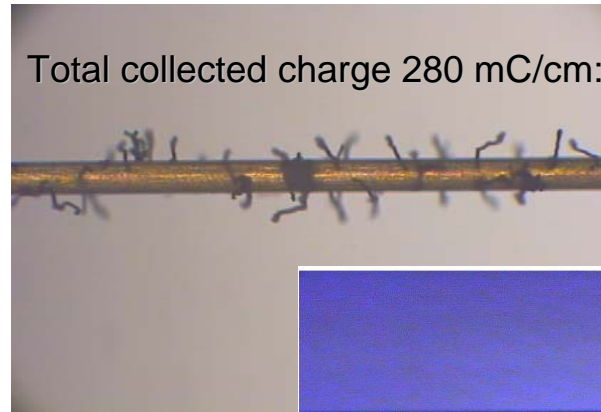
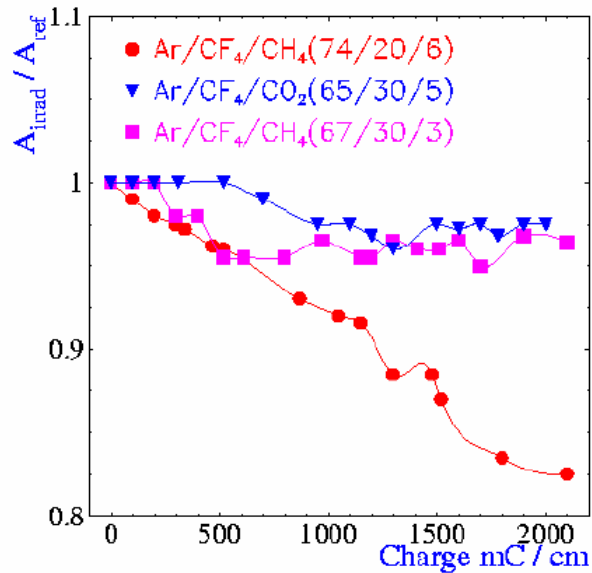

Aging Studies for the HERA-B Muon Detector

Full area (~1500 cm²) prototype chamber in the HERA-B: Ar/CF₄/CH₄ (67:30:3) + 500 ppm H₂O

Gain reduction and Malter currents for wires operated at gain >10⁵ appeared at 25 mC/cm:

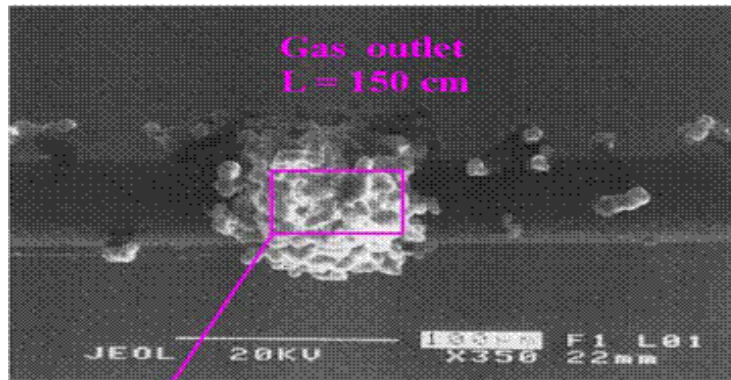

Wire deposits, containing only C and F (H is not observable)

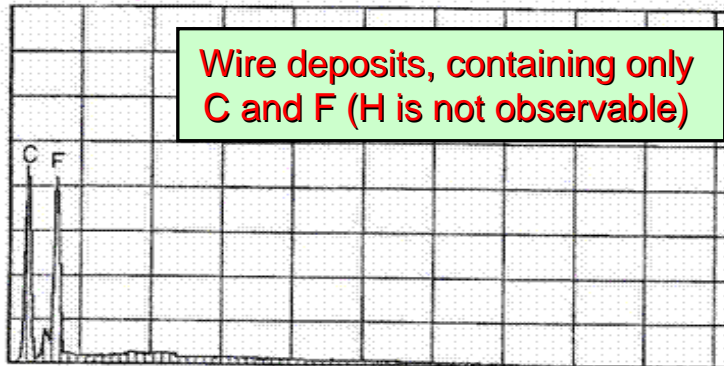

Progressive deterioration of performance in the direction of the serial gas flow

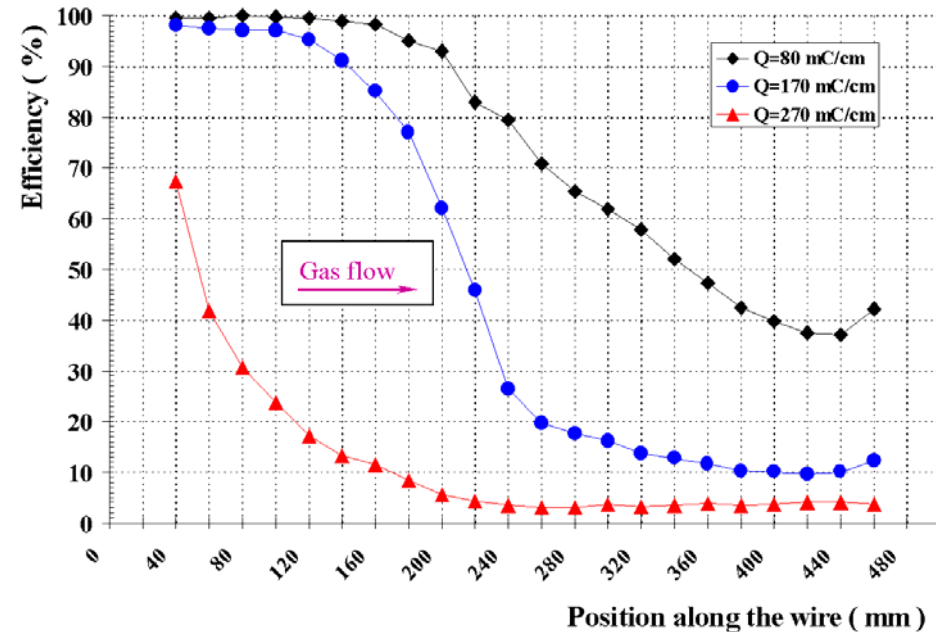

Strong Aging Dependence from:

High voltage
Area of irradiation

CF₄/Hydrocarbon mixtures: etching vs polymerization (I)

Laboratory wire chamber studies with CF₄/iC₄H₁₀: there appears 2 regions of polymerization and etching:

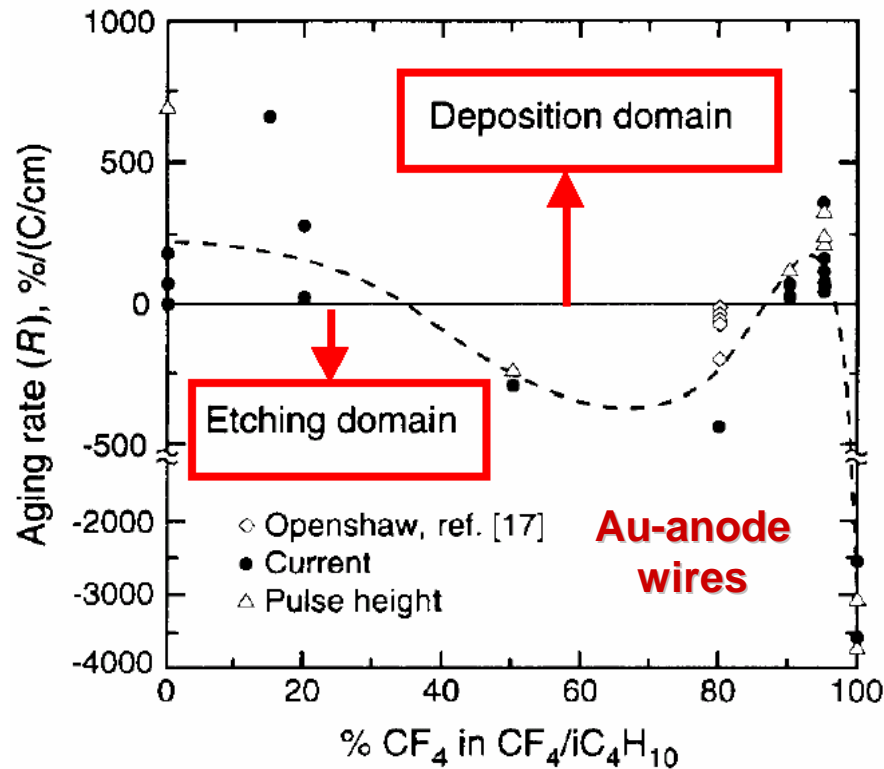

Heavy deposits are observed on the non-gold anode wires in all studied CF₄/iC₄H₁₀ mixtures regardless of whether or not that mixture lies in the etching region

J. Wise, J. App. Physics, 74(9) 5327

Several studies have demonstrated excellent aging properties of CF₄/iC₄H₁₀ (80:20) up to 10 C/cm BUT!!!

19960048116 National Lab. for High Energy Physics, Ibaraki, Japan

Enhancement of etching ability due to the addition of a trace of oxygen to the CF₄/iC₄H₁₀ (80:20)

Nakamura, Seiichi, National Lab. for High Energy Physics, Japan; Kondo, Takahiko, National Lab. for High Energy Physics, Japan; Oct. 1995, 40p; In Japanese

Report No.(s): KEK-95-11; DE96-750071; No Copyright; Avail: CASI; A03, Hardcopy; A01, Microfiche

We studied wire chamber aging for so called fast gas of CF₄/iC₄H₁₀ (80:20) under the high-radiation environment. It is clear that a trace of oxygen plays an important role. An addition of a trace of oxygen to this gas mixture is indispensable to steady operation of wire chambers in high-radiation environment. A lack of the oxygen leads to quick formation of deposits on the sense wire just after the irradiation. With a trace of oxygen, however, not only the gain stays constant for non-aged wires but also the gain recovers for aged wires. The recovery rate of the gas gain increases approximately proportionally to the oxygen concentration. It indicates that oxygen enhances the etching ability of the gas mixture. We guessed a mechanism based on the plasma chemistry of semiconductor product process.

DOE

Augmentation; Semiconductors (Materials); Quenching; Beta Particles; Plasma Chemistry; Gas Recovery; Gas Mixtures; Irradiation; Etching; Oxygen; Methane

CF₄/Hydrocarbon mixtures: etching vs polymerization (II)

Plasma chemistry:

- CF₄ is a very difficult gas to polymerize, but it does polymerize often by taking H out of material such as polymers used in the reactor
- CF₄ is an excellent etching gas for Si and Si-containing materials, because it reacts to form volatile Si-F based compounds
CF₄ is not a good etching gas for organic molecules that do not contain Si in the backbone chain and contains a lot of H.
- The addition of oxygenated species shifts the chemistry of CF₄ toward etching, while the addition of hydrogenated species shifts the chemistry of CF₄ toward polymerization:
Ar/CF₄/CH₄ would form polymers (at least at low pressure)
Ar/CF₄/CO₂ seems to be perfect for not polymerizing gases

H. Yasuda, private communication

Gas Detectors:

- 1990: The dominant role of CF₄ etching was expected for CF₄/CH₄-based gases (proved by many laboratory aging tests)
- Severe anode and/or cathode aging was observed in hadron beams with CF₄/CH₄ (80:20), Ar/CF₄/CH₄ (74:20:6) and Ar/CF₄/CH₄ (67:30:3) (HERA-B)
 - Attempts to simulate environments with large radiation doses by forcing chamber to glow discharge revealed dramatical degradation of cathode foil in Ar/CF₄/CH₄ (74:20:6) (LHCb-2001-003)



In a view of a very small safety margins, operation of a very large systems with Ar/CF₄/CH₄ or CF₄/CH₄ mixtures under severe radiation conditions seems to be of considerable risk

Aging Studies for ATLAS Muon Drift Tubes (MDT)

Ar/CH₄/N₂/CO₂ (94:3:2:1): Strong dependence of the tube lifetime from

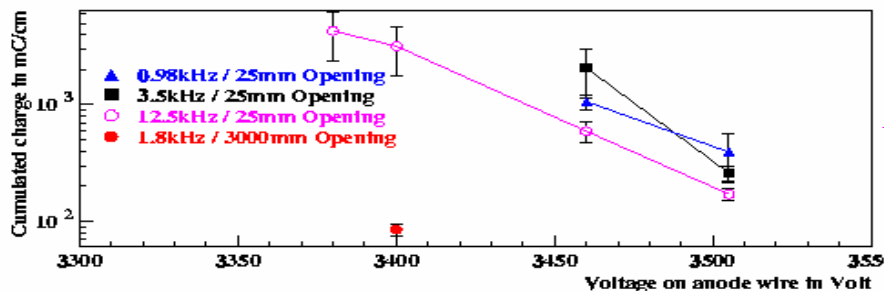

• High Voltage

Gas gain

Total charge of the avalanche

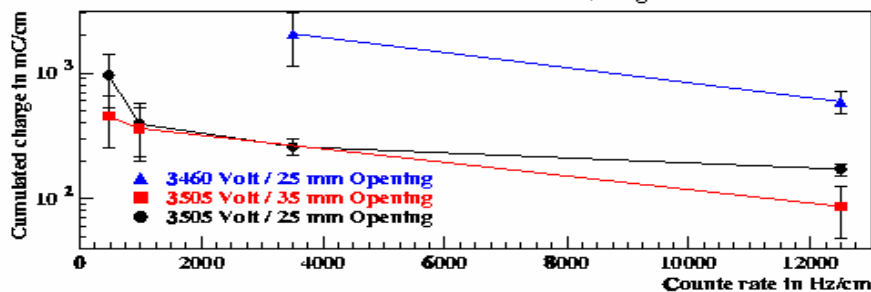

• Irradiation Rate

Concentration of reactive species

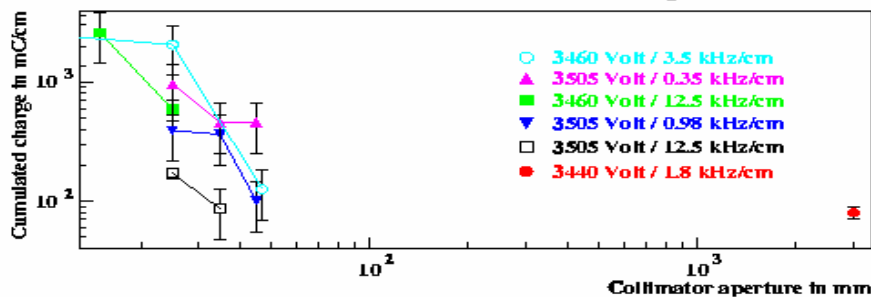

• Area of Irradiation

If long-lived species are produced in the avalanche the aging effects became non-local and intensity dependent

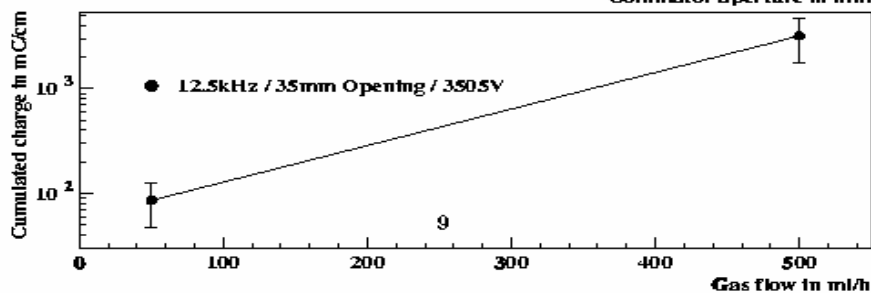

• Gas Flow Rate

M. Kollefrath et al.,
ATLAS MUON-NO-012 (2001)

Aging Studies for ATLAS Muon Drift Tubes (MDT)

Ar/CH₄/N₂/CO₂ (94:3:2:1): Most likely polymerization of hydrocarbons
(no indication that impurity/contamination caused aging effects)

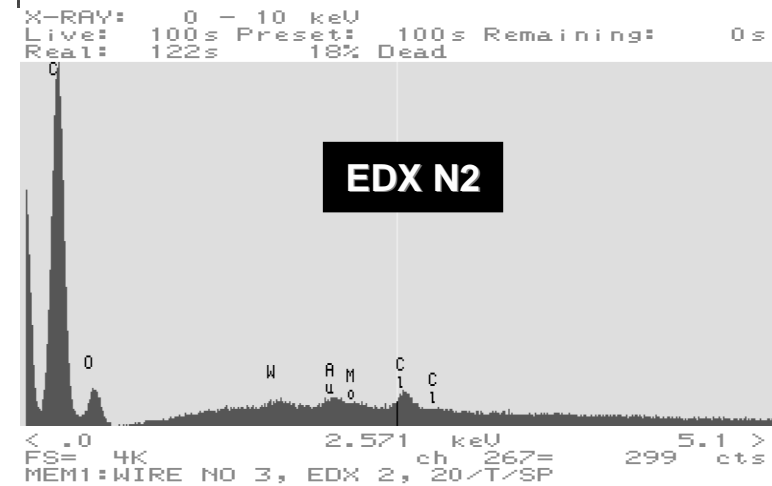
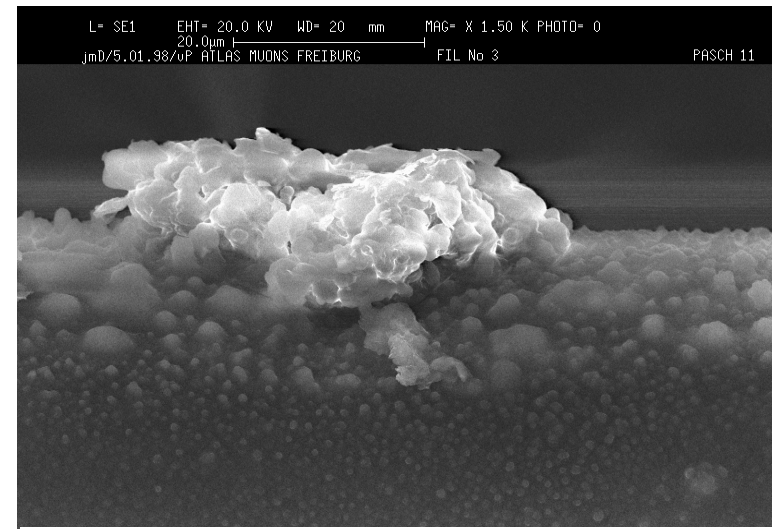
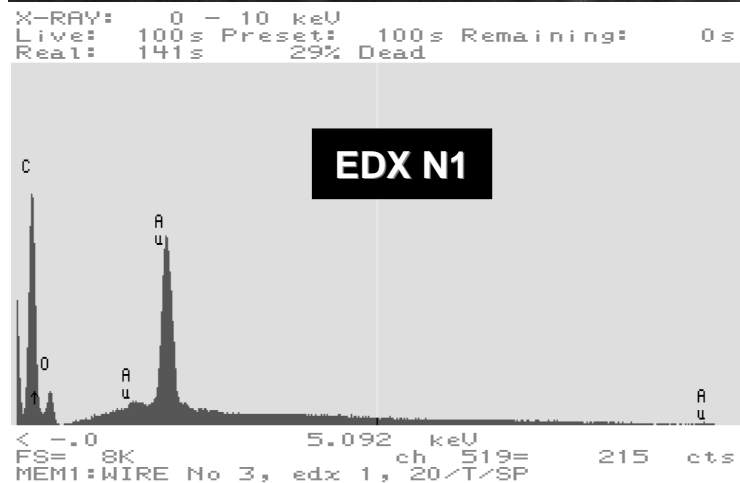
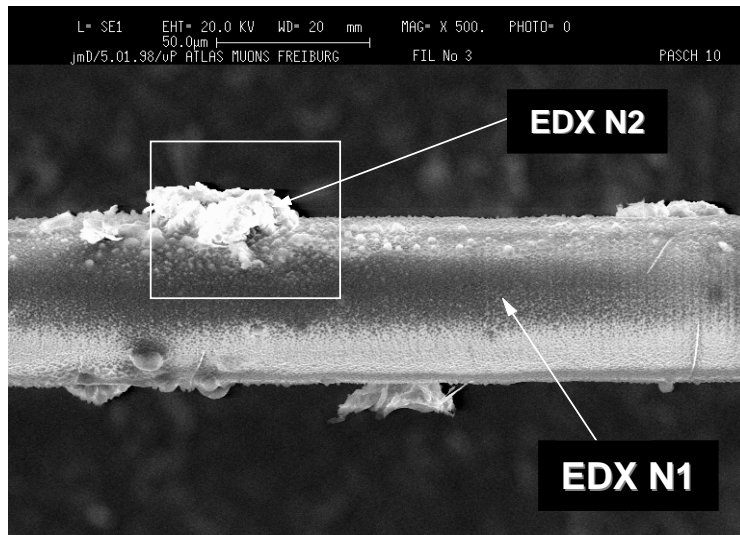

Some remarks on aging phenomena:

Description of aging rate by a single parameter: $R = -1/G(dG/dQ)$ is not adequate

Initial stage of radiation tests usually performed in the laboratory may not offer full information, needed to give an estimation about the lifetime of the real detector

Clear evidence for aging dependence on:



- size of irradiated area
- irradiation rate
- ionization density
- high voltage (gas gain)
- particle type and energy
- gas exchange rate



aging as non-local phenomena



Effect of microdischarges & Malter currents:
increase in polymer production rate or
production of new reactive species

The aging performance can not be predicted solely on the basis of atomic composition ratios of the mixture without taking into the actual discharge conditions

Choice of gases for high rate environment: Ar/CO₂

The Ar(Xe)/CO₂ gases could be in principle absolutely radiation resistant under clean conditions; there is no well-established mechanism which could lead to formation of anode deposits in these mixtures

ATLAS MDT
aging studies

To exclude statistical fluctuations of unknown nature
test set of chambers under identical conditions

Ar/CO₂ (93:7)
Number of tested tubes: **21**
Rate: 0.8-12.5 kHz/cm
Irradiation zone: 2.5-8 cm
Source: Am²⁴¹ (60keV)
All tubes are 100% efficient
after ~1.3 C/cm (avr.)

Ar/CO₂ (90:10)
Number of tested tubes: **47**
Rate: 1.8 kHz/cm
Irradiation zone: 340 cm
Source: Cs¹³⁷ (60keV)
All tubes are 100% efficient
after ~0.6 C/cm

Aging performance with Ar/CO₂ is extremely sensitive to traces of impurities:

Si-based pollutants are one of the main sources of anode aging
probably due to the production of non-volatile SiO₂

(CMS cathode strip chamber prototype – NIMA488(2002) 240;

ATLAS MDT prototype - G. Herten, R. Zimmernann, will be presented at 2003 IEEE NSS/MIC)

Choice of gases for high-rate environment: Ar/CF₄/CO₂

HERA-B MUON DETECTOR:
Ar/CF₄/CO₂ (65:30:5) +1000 ppm H₂O

No loss in performance was observed up to collected charge ~0.7 C/cm, whilst irradiating with 5 different gas gains (from 10⁴ to 3*10⁵)

LHCB full scale MWPC prototype:
Ar/CF₄/CO₂ (40:50:10)

No significant deterioration of chamber performance up to ~0.25 C/cm

CMS Cathode Strip Chamber:
Ar/CF₄/CO₂(30:50:20) & Ar/CF₄/CO₂ (40:50:10)

- No gain reduction in prototype chambers up to 13.5 C/cm, rate of accum. charge 0.3C/day
- No significant changes in large area chamber performance up to 0.4 C/cm.



Aging properties in Ar/CF₄/CO₂:

No loss in performance have been observed in clean setups, BUT !!!

- Some evidence of gold etching and wire surface damage (cracks)
- Accumulation of fluorocarbon deposits on the cathodes

Damage of the gold-plating of wires in Xe/CF₄/CO₂ (70:20:10)

- Main components responsible for anode wire damage (current densities $\sim 5\mu\text{A}/\text{cm}$) are reactive species produced in CF₄ avalanches (effect depends on type of wire)
- Neither gold wire damage nor cathode surface degradation in ATLAS TRT straws were observed for H₂O concentrations below 0.1% in Xe/CF₄/CO₂ up to 20 C/cm

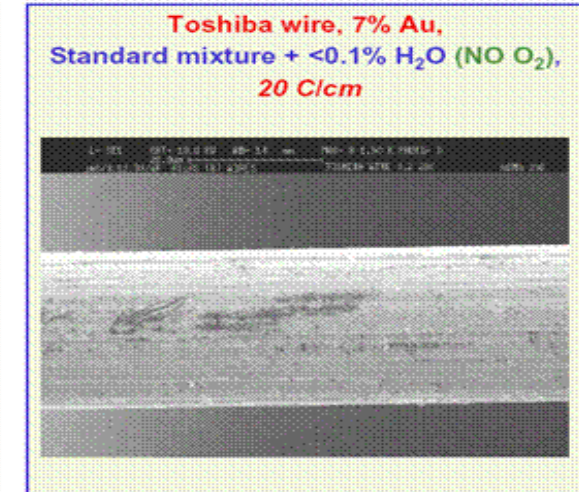
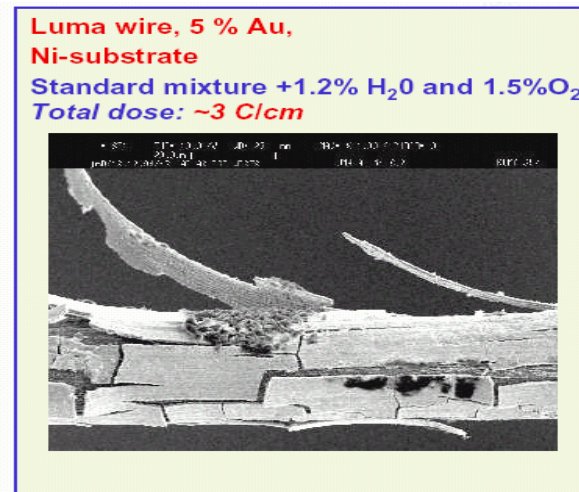
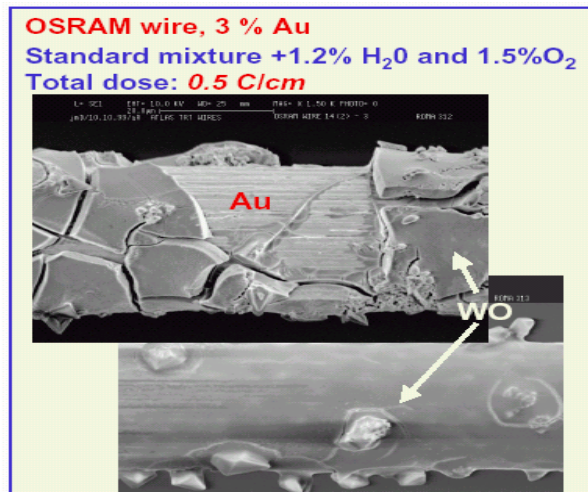
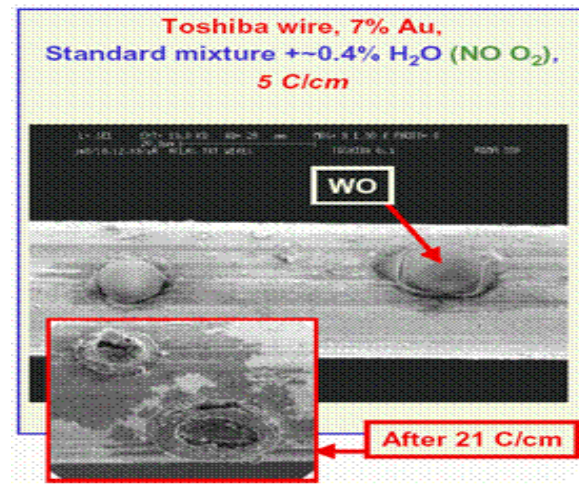
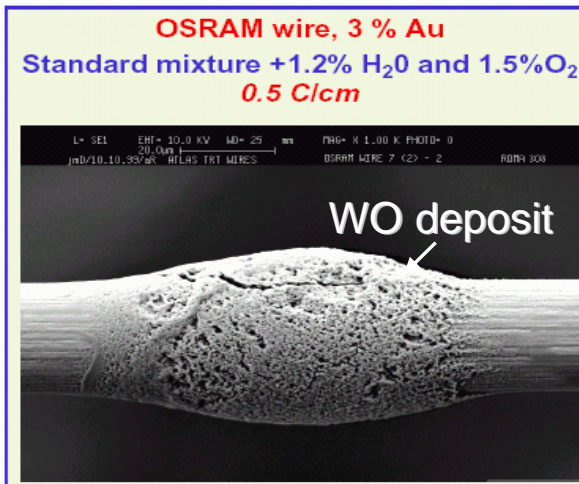
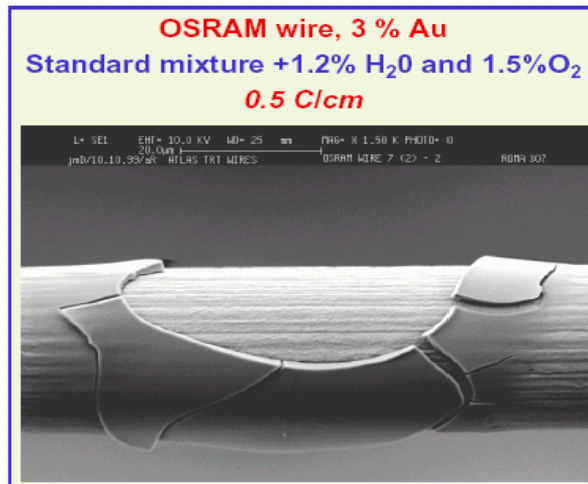

Etching of glass wires joints in Xe(Ar)/CF₄/CO₂ (70:20:10)

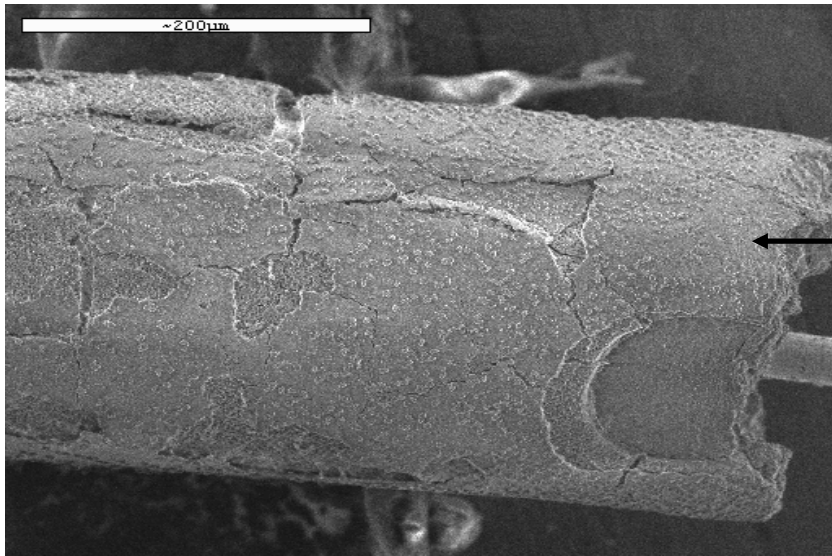

The ATLAS TRT glass wire joint separates electrically the barrel wire into two parts

- Much of the glass has been etched away and wire joints showed heavy cracks after irradiation in Xe(Ar)/CF₄/CO₂ at high dose rates
- No gain change due to Si etching from the glass wire joints (it seems that etched Si is in stable gas form and exits the system)
- Surface analysis of wire joints showed fluorine deposits while much of Si has disappeared

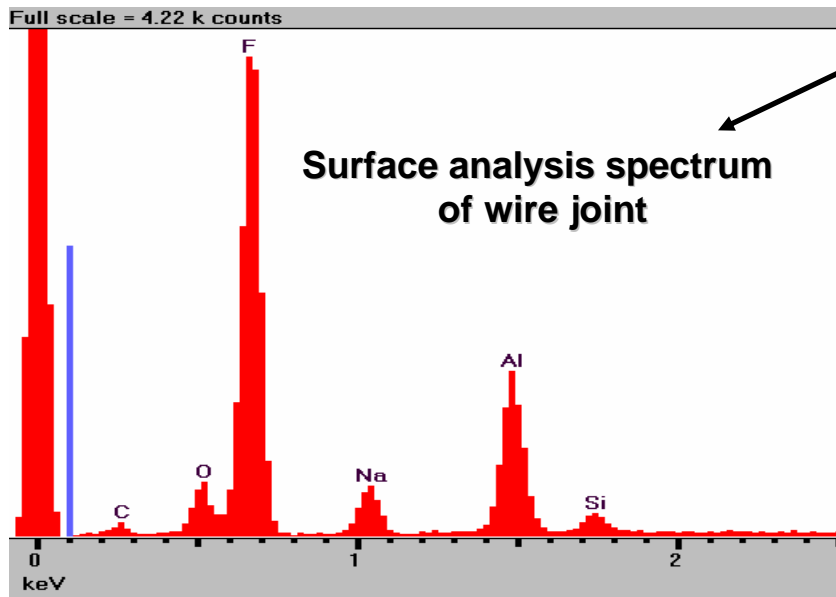

Baseline gas for the ATLAS TRT operation:
Xe/CO₂/O₂ (70:27:3)
(no indication of wire joint damage)

+

Run for short periods with CF₄-cleaning gas:
Ar/CF₄/CO₂ (70:3:27)
(Si-deposits on sense wires are of major concern)

Anode wire 'swelling' phenomena in CF₄ mixtures

Under high dose rates ($\sim 2 \mu\text{A}/\text{cm}$) in Xe/CF₄/CO₂, Ar/CF₄/CO₂ and in Ar/C₂H₂F₄/CO₂, the gold-plating of the wires was cracked, the wire diameter increased and a large amount of tungsten was observed on the tungsten in gold cracks

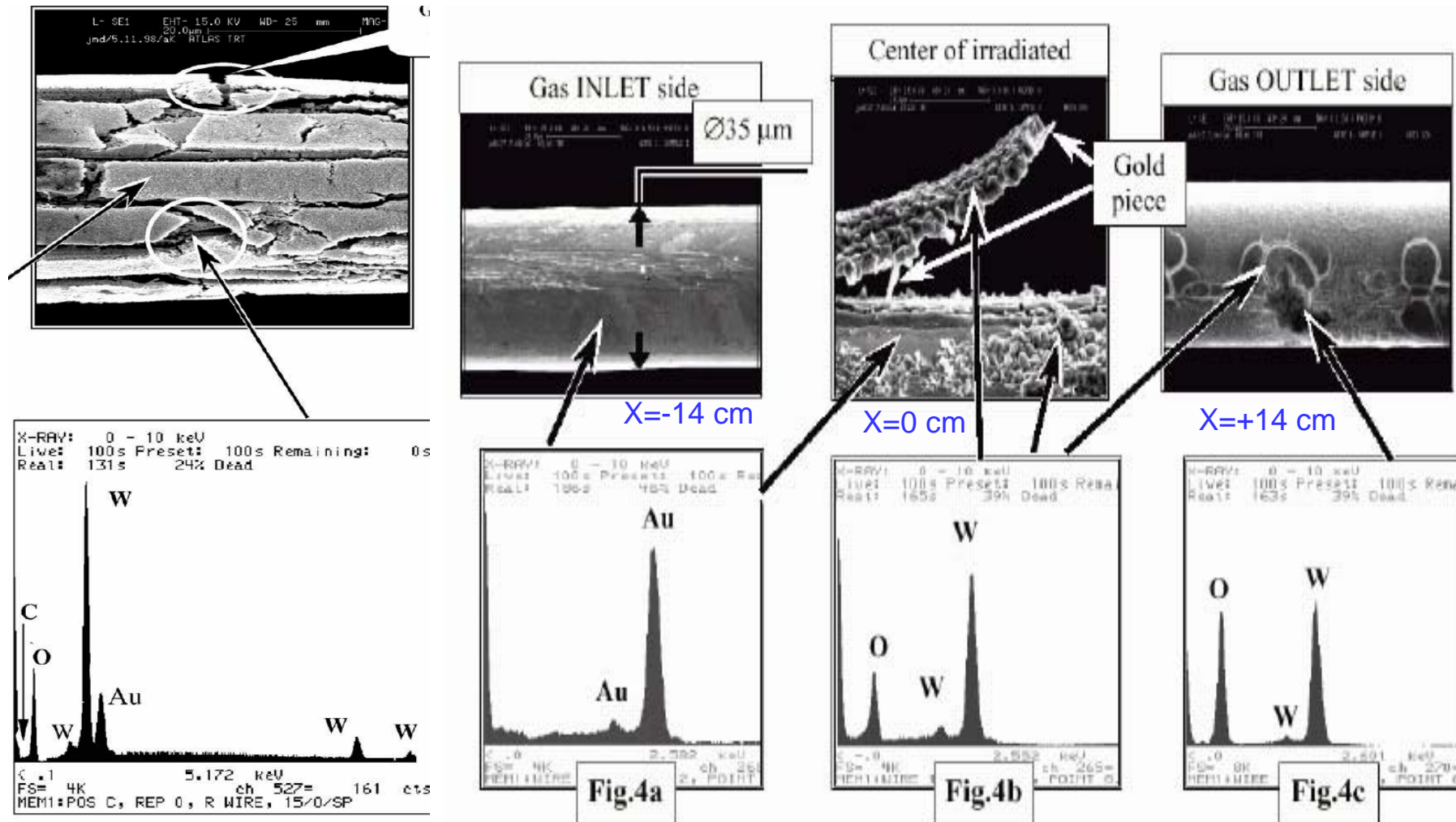

Electronegative radical production in CF₄ mixtures

Evidence of long-lived and highly electronegative radical production in the 'monitor chamber' downstream the strongly irradiated straw in Xe/CF₄/CO₂ (50:30:20):

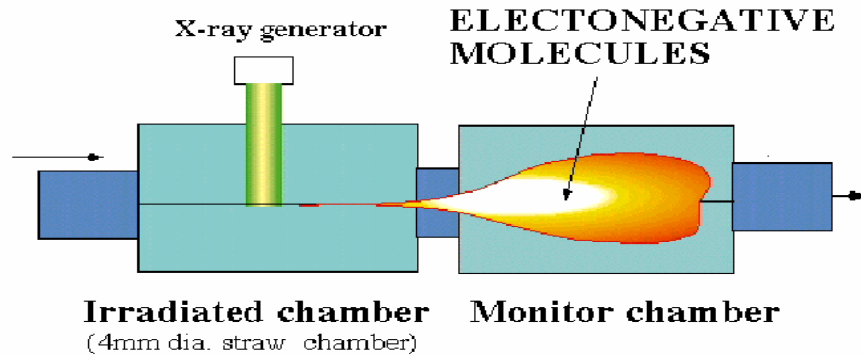

(M.Capeans et al., NIMA337 (1993)122,
V.Bondarenko et al., Nucl.Phys.B 44(1995)577)

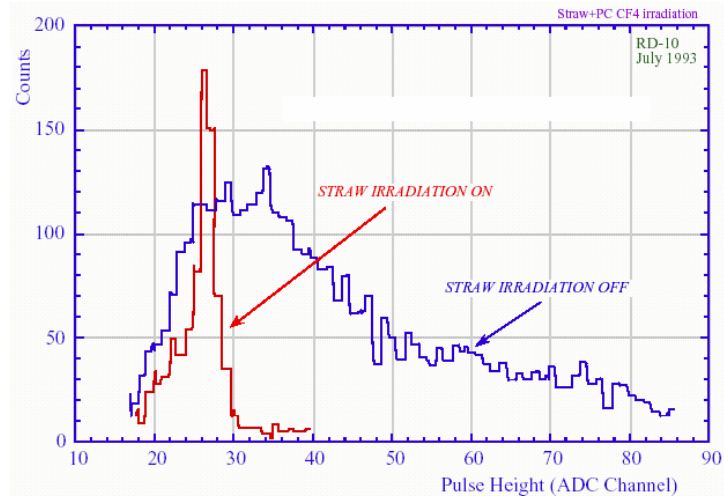

Gas flow dependence of the current for the 'partially' aged wires in Ar/CF₄/CH₄ (67:30:3):

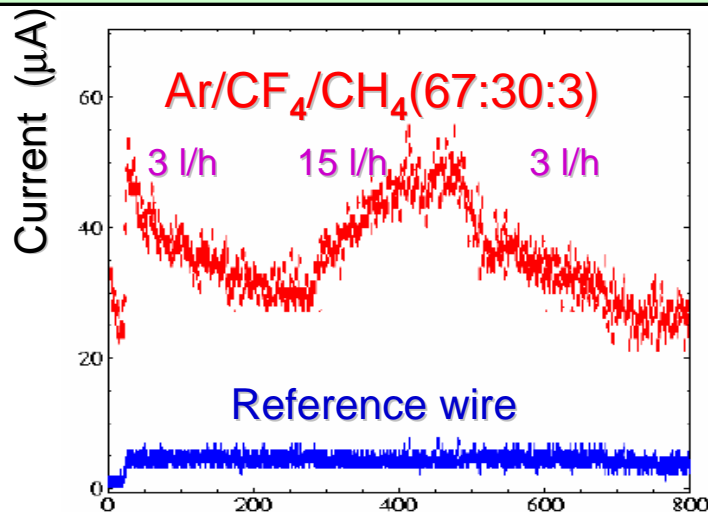

M. Titov et al., Proc. of Aging Workshop 2001

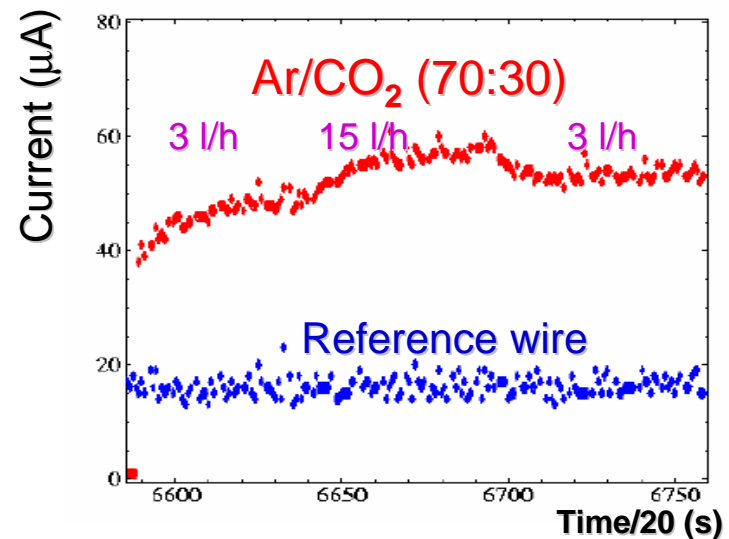

Large system aspects for the high-rate detectors of the LHC era

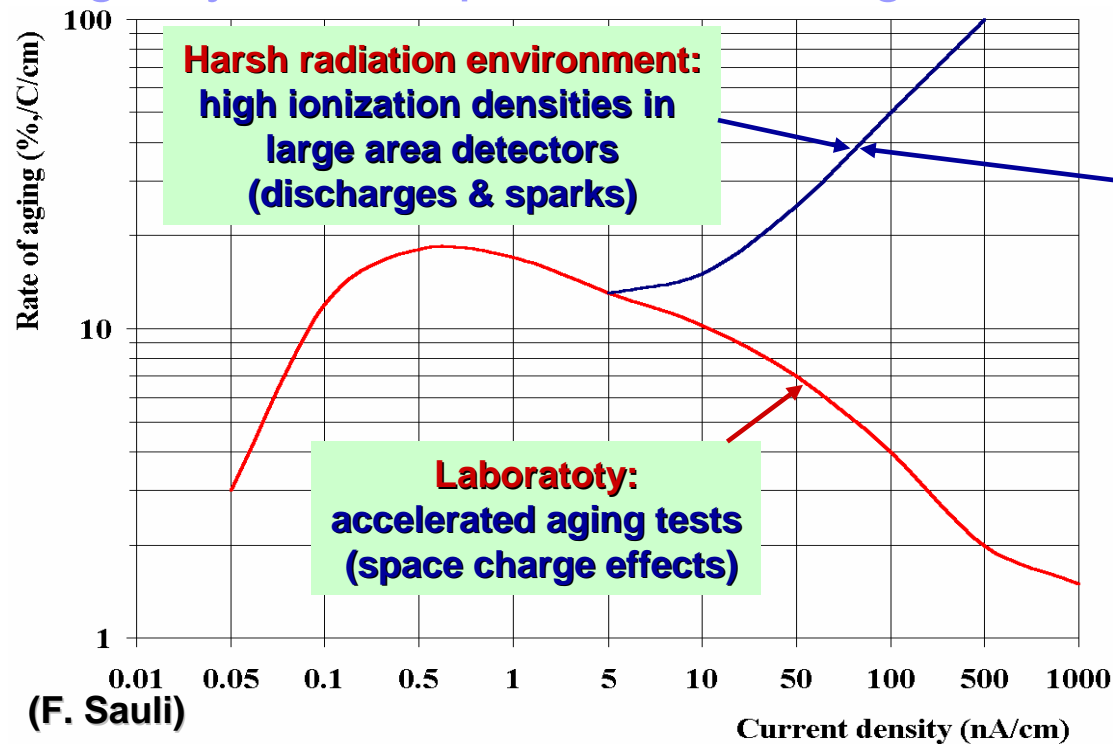

Exposure of 'large scale' detectors in the high-rate experiments:

- Discharges, sparks, breakdowns could partly simulate environments with large radiation doses
- Aging is non-local phenomena (progressive deterioration of performance along the gas flow)
 - A real large system will always contain some degree of imperfection and pollution – despite all precautions – risk of glow discharges/Malter currents (increased rate of chemistry processes)
- The counting gas under self-sustained discharge is much better conductor than many insulators

Aging Phenomena in Gaseous Photodetectors

First Generation of Photon detectors:

- At low rates the possibility to use at long-term with hydrocarbon/TMAE has been demonstrated for large 4π devices (SLD CRID, DELPHI RICH)
 - The use of gaseous photoconverters (TMAE, TEA) is excluded for high-rate applications

New Generation of Photon Detectors:

Solid photocathodes (CsI, SbCs, CsBr,...) and wire chambers or GEM

Several phenomena were suggested to cause a decay in photoemission properties of CsI:

- Exposure to H₂O or air
- Aging under photon flux
- Aging under ion bombardment
- Deposits on the photocathode surface due to hydrocarbon gas aging, which can also provoke sparking and Malter-type emission
- Gas impurities chemically reacting with photocathode surface

Mechanisms responsible for photocathode aging are not fully understood (probably due to an accumulation of several processes on the surface and in the subsurface layers, which change the electronic structure of the material)

References: J. Va'vra, NIMA387 (1997) 137-145 and 154-162; A. Breskin, NIMA371 (1996) 116-136; J. Va'vra, NIMA371(1996) 33-56; physics/0206059; A. Di Mauro, Proc. of 2001 Aging workshop

Summary of photon and ion-induced aging studies of CsI

- Large spread of decay rates, which is expected due to the different experimental conditions

Author	Thickness (Å)/substrate	Exposed to air	Flux		Detector	Gas, pressure	Gain	TPL of photocurrent ($\mu\text{C}/\text{mm}^2$)	QE consistent/ remarks	
			(photon/ $\text{mm}^2 \text{ s}$)	(pA/ mm^2)						
Dangendorf [14]	> 2000 Å/Al	1 min	10^{13} (185 nm)	2×10^5	PP	CH ₄ 20 Torr	1	2	Not provided	
			10^{11}	2×10^5		20 Torr	100	4	Same	
			10^{11}	2×10^5		100 Torr	100	8	Same	
			10^8	700		10 Torr	350	0.4	Same	
Anderson et al. [24]	5000/Al	10 min	Unknown (180 nm)	~ 70	PP	vacuum	1	~ 0.5	Not provided	
			Same	~ 70		C ₂ H ₆ 20 Torr	1	4	Same	
			Same	~ 70		CH ₄ 20 Torr	1	$\gg 4$	Same	
			Same	~ 70		i-C ₄ H ₁₀ 20 Torr	1	$\gg 4$	Same	
			Same	600		i-C ₄ H ₁₀ 20 Torr	1	27	Same	
			Same	Unknown		i-C ₄ H ₁₀ 20 Torr	3.5×10^4	$\gg 4$	Same	
Lu et al. [25]	5000/Al	Shortly	Unknown(195 nm)	Unknown	MW	Vacuum	1	0.1 (two components)	RQE, consistent	
			Same			C ₂ H ₆ 20 Torr	300	13 (190 nm)	RQE, consistent	
			Unknown(180 nm)			C ₂ H ₆ 20 Torr	10^4	30 (190 nm) two components	Only RQE	
			Same			C ₂ H ₆ 20 Torr	10^5	15 (190 nm) two components	Same	
Krizan et al. [13]	5000/Cu	Yes	10^5 (180 nm)	200	MW	CH ₄ 1 atm	10^5	100	RQE, consistent	
			Same	200		CH ₄ 1 atm	10^5	20	Same	
Va'vra et al. [27]	9000/Cu + Sn/Pb	2-5 min	Same	200	MW	CH ₄ 1 atm	10^5	100	Same	
			5000/SS + Al	1.2×10^{10} (185 nm)		300	CH ₄ 1 atm	1	20	Not provided
			5000/SS + Al	10^4 (185nm)		16	CH ₄ 1 atm	10^5	1	Abs. QE, consistent
Rabus et al. [28]	5000/Cu + Sn/Pb	Yes	Same		PP	CH ₄ 1 atm	10^5	7	Same	
			5000/Cu + Ni/Au	Same			CH ₄ 1 atm	10^5	90	Same
			5000/SS + RSG ^a	5×10^{12} (150nm)		300	Vacuum	1	8	Only abs. QE
This work	5000/SS + Al	No	5000/Cu + Ni/Au + RSG ^a	Same	PP	Vacuum	1	8	Same	
			1.2×10^6 (160 nm)	330		CH ₄ , 50 Torr	10^4	43	Abs. QE, consistent	
			Same	31		CH ₄ , 50 Torr	10^3	26 (15% loss)	Abs. QE, partial cons.	

B. Singh et al., NIMA454 (2000) 364.

Progress in GEM-based gaseous photomultipliers

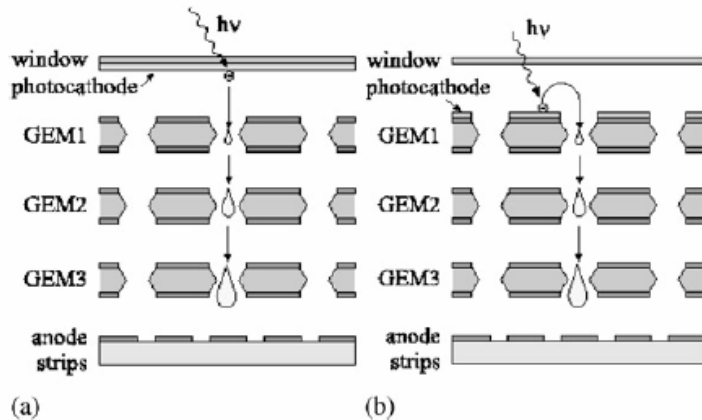

Fig. 1. The operation principle of the multi-GEM gaseous photon detector with a semitransparent (a) and a reflective (b) photocathode.

Sealed multi-GEM structure with semitransparent CsI photocathode and Ar/CH₄ (95:5) gas filling:

- Aging rate is mostly affected by the voltage drop across a single GEM and comparable to that measured in unsealed detectors
(A. Breskin et al., NIMA478 (2002) 225)

The Hadron Blind Detector for the PHENIX Experiment at RHIC:

Windowless Cherenkov detector; same radiator and detector gas - CF₄

Transmissive CsI photocathode (relatively high QE, no photon feedback)

Gas Detector: multi-GEM structure (high gain operation in purely quenched gases, reduced ion feedback)

First proof of CF₄ compatibility with CsI + Triple GEM:

- No aging effects in GEM foil up to 10 mC/cm²
- No degradation of the CsI QE for a total ion charge 7 mC/cm²

(A. Kozlov et al., physics/0309013)

Other references: I. Tserruya, BNL, Dec.19 (2002); NIMA502 (2003) 195; NIMA483(2002) 670

RPC Systems at the HEP Experiments

Mid'1990: RPC's are though to be a robust, economical and proven technology, which allows to cover large areas at low cost

Experiment	Status	Electrodes material & resistivity	Gas mixture	Operation mode; charge/track	Particle rates ; Accumulated charge
L3	Finished	Oiled bakelite $2 \cdot 10^{11} \Omega \text{cm}$	Ar/iC ₄ H ₁₀ /C ₂ H ₂ F ₄ (57:37:6)	Streamer	Consistent with cosmic rays
Belle	In progress	Float glass $10^{12} - 10^{13} \Omega \text{cm}$	Ar/iC ₄ H ₁₀ /C ₂ H ₂ F ₄ (30:8:62)	Streamer	$\sim 10\text{-}20 \text{ Hz/cm}^2$;
BaBar	In progress	Oiled bakelite $10^{11} - 10^{12} \Omega \text{cm}$	Ar/iC ₄ H ₁₀ /C ₂ H ₂ F ₄ (60.6:4.7:34.7)	Streamer 1000pC/track	$\sim 10\text{-}20 \text{ Hz/cm}^2$; $< 10 \text{ C/cm}^2$ (in 2010)
ATLAS	Planned	Oiled bakelite $2 \cdot 10^{10} \Omega \text{cm}$	C ₂ H ₂ F ₄ /iC ₄ H ₁₀ / SF ₆ (96.7:3:0.3)	Avalanche 30 pC/track	$< 0.1 \text{ kHz/cm}^2$; $< 0.3 \text{ C/cm}^2$
CMS barrel	Planned	Oiled bakelite: $10^{10} \Omega \text{cm}$	C ₂ H ₂ F ₄ /iC ₄ H ₁₀ / SF ₆ (96:3.5:0.5)	Avalanche 30 pC/track	$< 0.1 \text{ kHz/cm}^2$; $< 0.3 \text{ C/cm}^2$
ALICE	Planned	Oiled bakelite $3 \cdot 10^9 \Omega \text{cm}$	Ar/iC ₄ H ₁₀ /C ₂ H ₂ F ₄ / SF ₆ (49:40:7:1)	Streamer	$< 0.1 \text{ kHz/cm}^2$; $< 0.2 \text{ C/cm}^2$
LHC-b	Abandon	Oiled bakelite $9 \cdot 10^9 \Omega \text{cm}$	C ₂ H ₂ F ₄ /iC ₄ H ₁₀ / SF ₆ (95:4:1)	Avalanche 30 pC/track	$0.25\text{-}0.75 \text{ kHz/cm}^2$; $0.35\text{-}1.1 \text{ C/cm}^2$

Aging Experience in Belle RPC

'98: High dark currents and efficiency drop were observed in glass RPC's:
(problem was due to ~ 2000 ppm of H₂O, permeating through the walls of plastic tubing)

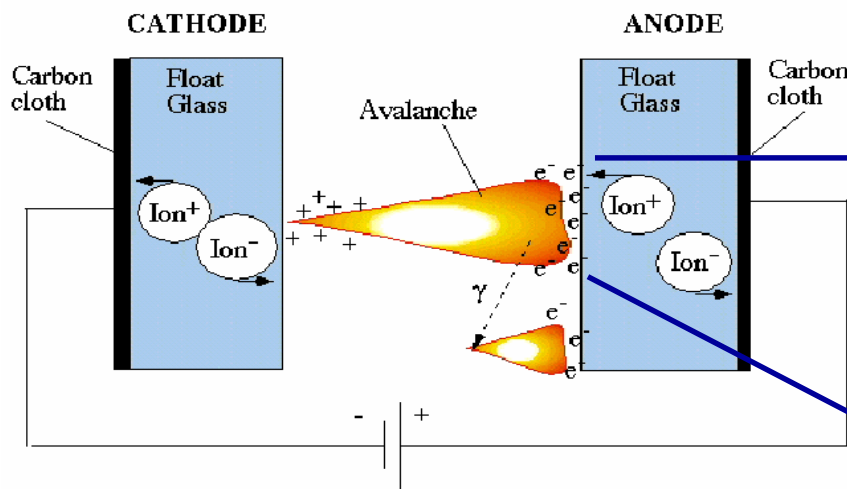

This behavior was interpreted as a result of the HF acid production, which caused etching of the glass surfaces and created emission points, triggering chamber currents

A solution emerges: replace polyethetele tubing with copper ones (<10 ppm H₂O)
Good detector performance so far

Surface of 'Good Anode':

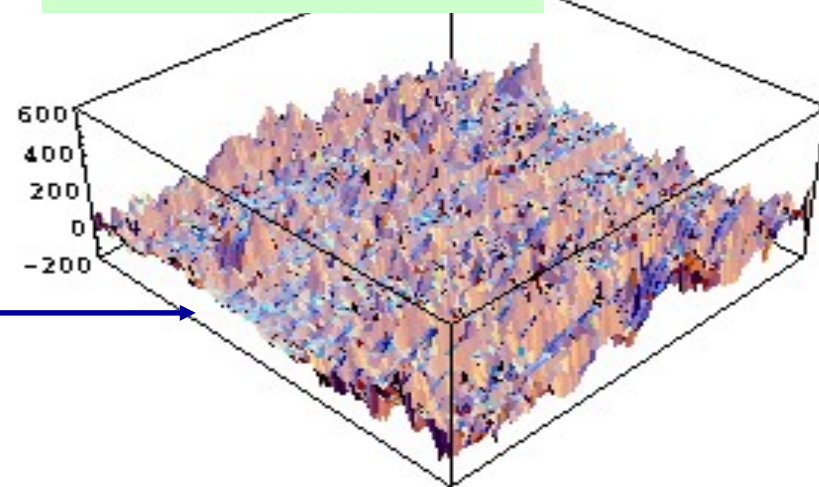

Surface of 'Bad Anode':

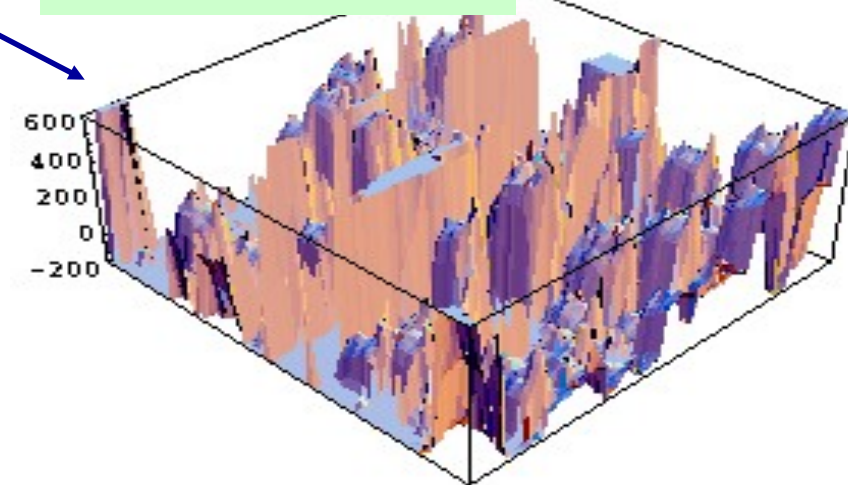

Aging Experience in BaBar RPC

Chronology of events:

July'99: Linseed oil RPC's showed large dark currents and sharp efficiency drops following operation at high temperature and currents.

This problem was related to the excess of uncured linseed oil; electrochemical change of the linseed oil resistivity ($8 \cdot 10^9 \Omega\text{cm} \rightarrow 2 \cdot 10^8 \Omega\text{cm}$) and formation of oil droplets and bridges, which effectively shorts electrodes

Nov.'00: 24/216 forward RPCs were replaced with single oil coated chambers (LHC style)

- Observe some degradation of efficiency;
- Beam tree pattern` on ~5% of the buttons on the anode; many sparking spots near the oil droplets at the cathode and along the chamber edges

Dec.'02: Replacement of all forward RPC's with new ones

better quality control, so far good behaviour
Outer FW layers are off because they are tripping during regular BaBar running

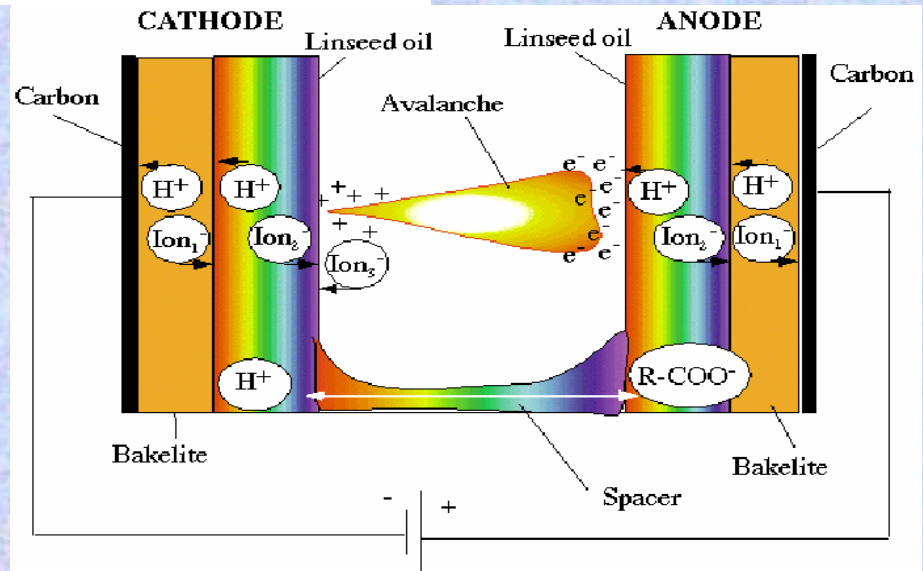

Beam Tree patterns on the anode

ATLAS RPCs

- Systematic tests have shown an increase of the total plate resistance as the only relevant aging effect

- After 12 eq. LHC years: a decrease of rate capability from 1.6 kHz/cm² to 300 Hz/cm² was observed

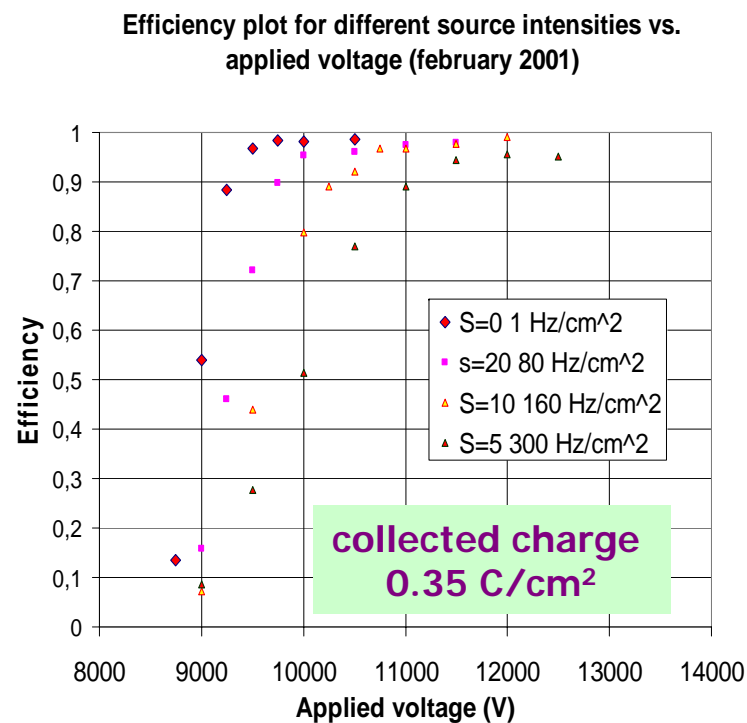

NIMA 478(2002) 271;
A.Aielli et al., Proc. of 2001 Aging Workshop

CMS RPCs

No permanent changes in both RPC efficiency and noise were observed after collected charge of 0.05 C/cm²

G. Pugliese et al., Proc. of 2001 Aging Workshop

ALICE RPCs

RPC efficient after charge 0.2 C/cm²
(80 LHC periods)

An increase of dark current and counting rate observed during the aging test can be strongly suppressed by the:

- reduced content of SF6 (1% vs 4%)
- more robust double oil coating

W/o HV: bakelite resistivity increases with dry gas, stable with humid gas

A. Ferretti, E. Vercellin (2002)

Aging Experience in LHC-b RPC

Irradiation at CERN GIF in 2001:
Steady exponential decrease of current by a factor of ~ 6

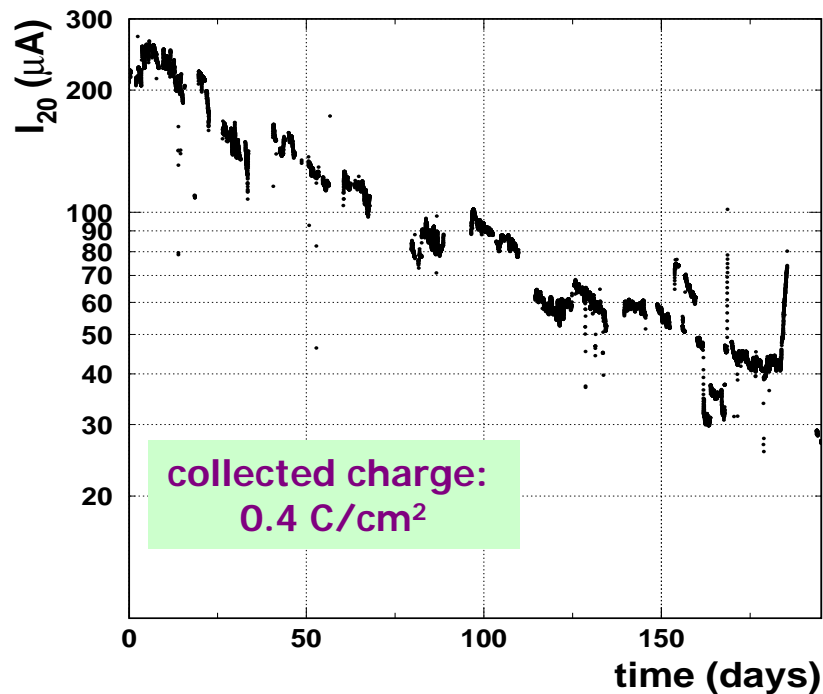

as a result of corresponding increase of the bakelite resistance due to the current flowing through the electrodes

New aging tests in 2002:
Pure spontaneous aging is the dominant effect → could be related to the decrease of water content in bakelite

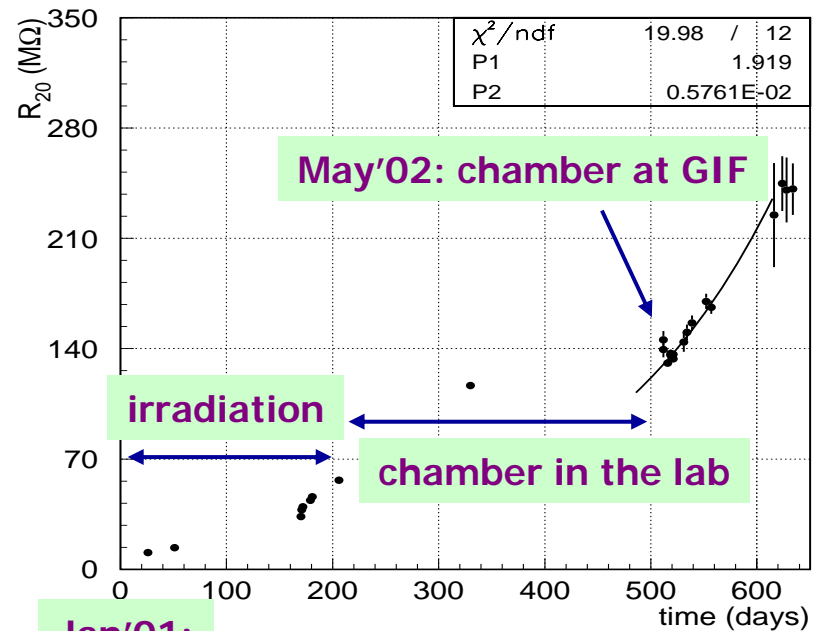

Rate capability dropped from a few kHz/cm² to less than 150 Hz/cm²
NO RPC in LHC-b

Concerns for the long-term stability of RPC's (I)

The bakelite volume resistance and linseed oil surface resistance can be altered by:
presence of water, integrated current, temperature and possible complicated fluorocarbon chemistry

Glass RPC: conductivity of glass is not stable (electron conductive glass was chosen for the MSGC substrate).

- Short exposure to Freon+streamers+H₂O leads to reversible loss of efficiency; long-term operation causes permanent RPC damage.

New Bakelite with the new Linseed oil treatment **J. Va'vra**

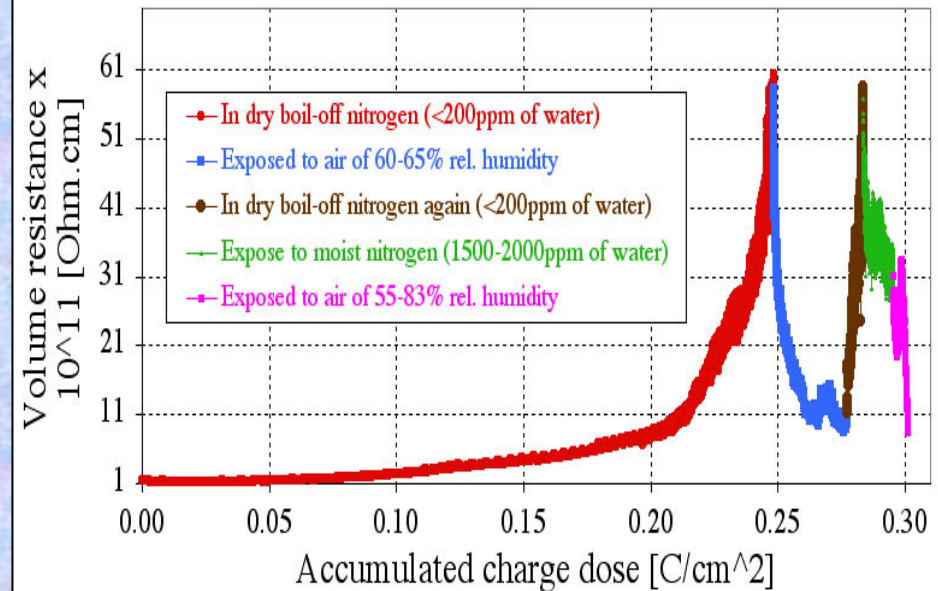

Y. Teramoto, RPC 2001, Coimbra

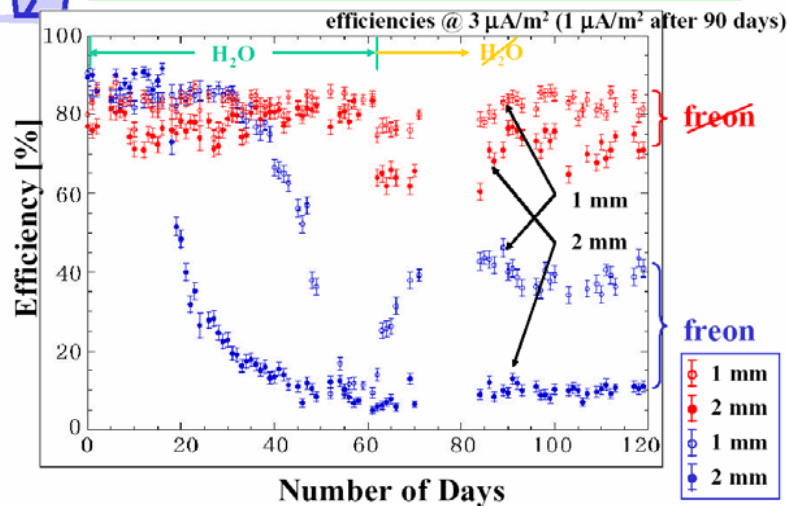

A. Tonazzo, IEEE (2002)

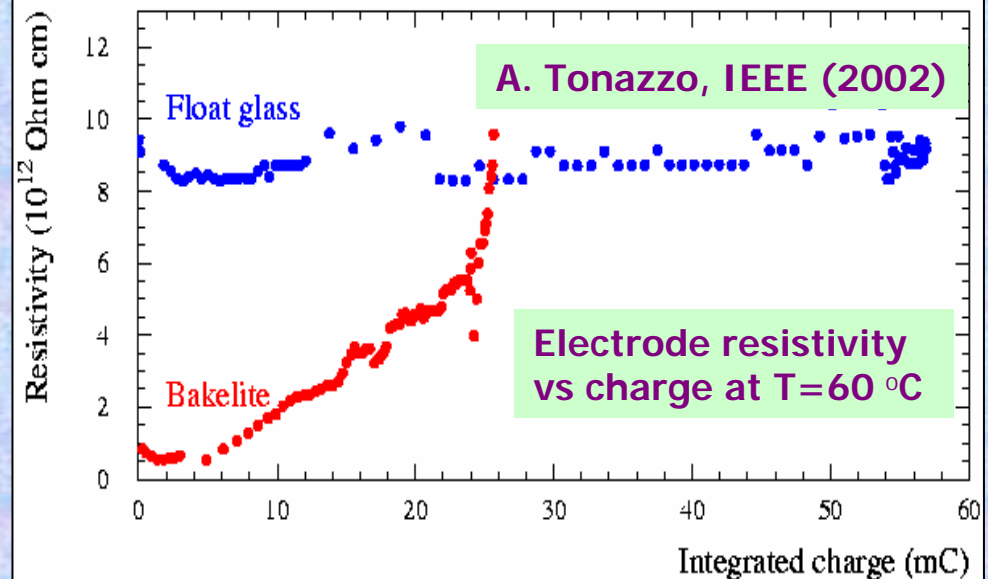

Concerns for the long-term stability of RPC's (II)

- The charge exchange mechanism has to work well between various types of ions to prevent charging effects at various boundaries: gas, the linseed oil, the Bakelite and the graphite.
(J.Va'vra, SLAC Logbook)

Long-term problems with RPC's are not classical aging effects (unpredictable surface effects)

RPC detectors are demonstrated to work; sufficient gas flow is essential for stable running

Other references:

- D. Marlow, Rice University seminar, July 9 (1999)
 - Proceedings of the `RPC2001`, Coimbra
- A. Sharma, CERN seminar, Nov.22 (2002)
- J. Va'vra, Talk at SLAC, Jan.25 (2003)



Could we expect classical aging effects in $C_2H_2F_4/iC_4H_{10}$ -based mixtures ?

Plasma chemistry says - yes !!!

Wire chamber aging observed in $Ar/CF_4/CH_4$

- Much smaller accumulated charge in RPCs
1C/cm² RPC eq. to 0.1-1 mC/cm in wire chamber
 - **BUT**, if there is a localized discharges → large charge doses could be accumulated locally

First evidence for the freon-based chemistry affecting the RPC electrode resistance (operating in streamer mode):

BaBar RPC: around every sparking spot with a `beam tree pattern` there is a film, having much lower surface resistivity than linseed oil, which is believed to be formed from freon chemistry

Glass RPC: Deposits were formed both on the anode (containing high level of fluoride) and cathode surfaces (field emission of electrons from cathode was observed) in

$Ar/iC_4H_{10}/C_2H_2F_4+H_2O$

hep-ex: 0211020 and Y. Teramoto RPC,2001

Radiation Damage and Long-term Aging can be minimized by:

1. Careful choice of construction materials: radiation hardness and outgassing properties are of a primary importance

(There are clearly many 'bad' and a lot of 'usable' materials.

A material is adequate or not for a very particular detector type and operating conditions → test to match your specific requirements)

2. Use of aging resistant gases: noble gases, CF_4 , CO_2 , O_2 , H_2O , alcohols are the most attractive candidates for the high-intensity environments;

(Hydrocarbons are not trustable for long-term high rate experiments; operational problems could be aggravated by CO_2 as a quencher and by the very high aggressiveness of dissociative products of CF_4)

3. Adequate assembly procedures, maximal cleanliness for all processes and quality checks for all system parts (personnel training, no greasy fingers, no polluted tools, no spontaneously chosen materials installed in the detector or gas system in the last moment, before the start of real operation)

4. Careful control for any anomalous activity in the detector: dark currents, variation of anode current, remnant activity in the chamber when beam goes away. (Use oxygen-based molecules to inhibit/relief/cure polymerization of hydrocarbons, operation with CF_4 decreases a risk of Si polymerization)

Radiation Damage in Gas Detectors: Summary and Outlook

Stable and reliable operation of fast gaseous detectors at large scale for high rate tracking in hostile environments has been demonstrated by many experiments

With the increasingly stringent requirements of modern experiments, geometry, configuration of electric field, construction and electrode materials and operating gases have been the subject of extensive studies and optimization efforts

In the real experiments, especially at high rates, it is impossible to fully avoid sparking, originated from heavily ionizing particles or defects in the electrodes (sharp points or microscopic dielectric insertions on cathodes)

Choice of electrode structures and gas are crucial

allow small discharges, but must avoid fundamental problems
(big discharges and self-sustained currents causing permanent damages)

Detectors, which use insulators (RPC, MPGD, CsI) may face a new domain of aging: radiation induced increase of bulk resistivity of electrodes and supporting structures due to ionic currents → decreased maximum rate capability

Since the present state of knowledge does not allow to formulate a complete set of recommendations of how to prevent aging effects in wire chambers, it is important to study the aging properties under conditions as close as possible to real ones.

Acknowledgment

I am especially thankful to

Fabio Sauli, Archana Sharma, Jerry Va'vra, Vladimir Peskov,
Mar Capeans, Gregor Herten, Anna Di Ciaccio, Hirotugu Yasuda,
for many helpful discussions during preparation of this presentation
and for the possibility to present so wide spectrum of the aging results.

Aging Workshop '2001: Recommendations how to plan aging tests...

Since the present state of knowledge does not allow to formulate a complete set of recommendations of how to prevent aging effects in wire chambers, it is important to study the aging properties under conditions as close as possible to real ones.

The fundamental problem: you can not do a 'real time test'
How is it possible to learn in a reasonable time about the long-term aging behaviour?



- Build a 'full size prototype detector'
(the smallest full size independent element of your detector)
- Expose full area of detector to real radiation profile (particle types)
 - Choose your gases and materials very carefully
- Vary all parameters systematically (gas gain, irradiation intensity, gas flow, ...) and verify your assumptions...
- If you observed unexpected result - understand the reason of it
 - Reproduce your results...

Do we need a Global Universal Aging R&D facility ???

Talks and videos from the International Workshop on Aging Phenomena in Gaseous Detectors (DESY, October 2-5) are available on the webpage:
www.desy.de/agingworkshop

Outgassing Tests of Some Materials

- Epoxy Compounds
- Adhesive Tapes
 - Leak Sealers
- Rigid materials
- Contamination:
 - User-generated
 - Silicone

Outgassing of Epoxy Compounds

- Material itself
- User-generated
 - Pollution
- Incorrect ratio of hardener to resin
- Insufficient curing time

(M. Capeans - Aging Workshop 2001, DESY)

Low Outgassing Epoxy Compounds (Room T-curing)

Source	Product	Outgas	Effect in G.D.	Note
CERN/GDD	STYCAST 1266 (A+B)	NO	NO	Long curing time
HERA-B/OTR	STYCAST 1266 (A+Catalyst 9)	NO	NO	In Use
CERN/GDD	HEXCEL EPO 93L	NO	NO	Out of production
HERA-B/ITR	ECCOBOND 285	NO	NO	In Use
CERN/GDD ATLAS/TRT	ARALDITE AW103 (Hardener HY 991)	NO	NO	In Use
ATLAS/TRT	TRABOND 2115	NO	NO	In Use

'Rejectable Epoxy Compounds' (Room T-curing)

Source	Product	Outgas	Effect in G.D.	Result
CERN/GDD ATLAS/TRT	ARALDITE AW 106 (Hardener HV 935 U)	YES		BAD
CERN/GDD	DURALCO 4525	YES	YES	BAD
CERN/GDD	DURALCO 4461	YES	YES	BAD
CERN/GDD	HEXCEL A40	YES	-	BAD
CERN/GDD	TECHNICOLL 8862 + (Hardener 8263)	YES	-	BAD
CERN/GDD	NORLAND NEA 155	YES	-	BAD
CERN/GDD	EPOTEK E905	YES	-	BAD
CERN/GDD	NORLAND NEA 123 (UV)	YES	-	BAD

Full evidence of suitability
(long-term MSGC aging test) ←

Epoxy Compounds Curing at $T > 50\text{ C}$

(in order to increase the
sensitivity of the system,
samples warmed up)

Source	Product	Curing T (°C)	Outgas	Effect in G.D.	Result
CERN/GDD	EPOTECNY E505 SIT	50	YES	NO	OK
HERA-B/ITR	EPOTEK H72	65	YES*	NO	OK*
CERN/GDD	AMICON 125	85	NO	-	OK
CERN/GDD	POLYIMIDE DUPONT 2545	65	NO	-	OK
ATLAS/TRT	RUTAPOX L20	60	NO	-	OK
CERN/GDD	ARALDITE AW 106	70	YES		BAD
CERN/GDD	LOCTITE 330		YES	YES	BAD
CERN/GDD	EPOTECNY 503	65	YES (Silicone)		BAD
CERN/GDD	NORLAND UVS 91	50	YES	-	BAD

Conductive epoxy Compounds

Source	Name	Outgas	Effect in G.D.	Result
CERN/GDD	TRADUCT 2922	NO		OK
HERA-B/OTR	SILBER LEITKLEBER 3025 (A+B)	NO	NO	OK
ATLAS/TRT	TRABOND 2902	NO	NO	OK

Adhesive Tapes

Source	Name	Outgas	Effect in G.D.	Result
HERA-B/OTR	SCOTCH 467 MP	YES	-	BAD
HERA-B/OTR	TESAFIX 4388	YES	-	BAD

(M. Capeans - Aging Workshop 2001, DESY)

Outgassing Tests of Leak Sealers

Source	Material	Type	Outgas	Effect in G.D	Global Result
CERN/GDD	VARIAN Torr-Seal	Solvent-free epoxy resin	NO	NO	OK
CERN/GDD	RHODORSIL CAF4	Caoutchouc Silicone RTV	NO	NO in very small quantities	OK ?
CERN/GDD	DOW CORNING R4-3117 RTV	Silicone based	YES	NO in very small quantities	OK ?
HERA-B /OTR	LOCTITE 5220	Polyurethane-based	YES	-	BAD

Full evidence of suitability (long-term MSGC aging test)

Rigid Materials

Source	Name	Type	Outgas	Effect in G.D.	Result
CERN/GDD	STESALIT 4411W	Fiberglass	YES	NO	OK
CERN/GDD	VECTRA 150	Liquid Crystal Polymer	YES	NO	OK
CERN/GDD	PEEK Crystalline	Polyetherether ketone	NO	NO	OK
ATLAS/TRT	ULTEM	Polyetherimide	NO	-	OK
ATLAS/TRT	C-Fiber	C-fiber	NO	-	OK
ATLAS/TRT	POLYCARBONATE	C-fiber	NO	-	OK
HERA-B/ITR	FIBROLUX G10	Fiberglass	YES	-	BAD
HERA-B/ITR	HGW 2372 EP-GF	Fiberglass	YES	YES	BAD
CERN/GDD	RYTON	Polysulphur phenylene	YES	YES	BAD
CERN/GDD	PEEK Amorphous	Polyetherether ketone	YES	-	BAD

(M. Capeans - Aging Workshop 2001, DESY)

User-generated Outgassing

NEW vs EXPIRED: NUVOVERN LW -HARDNER PUR LW (Mader Lucke AG)

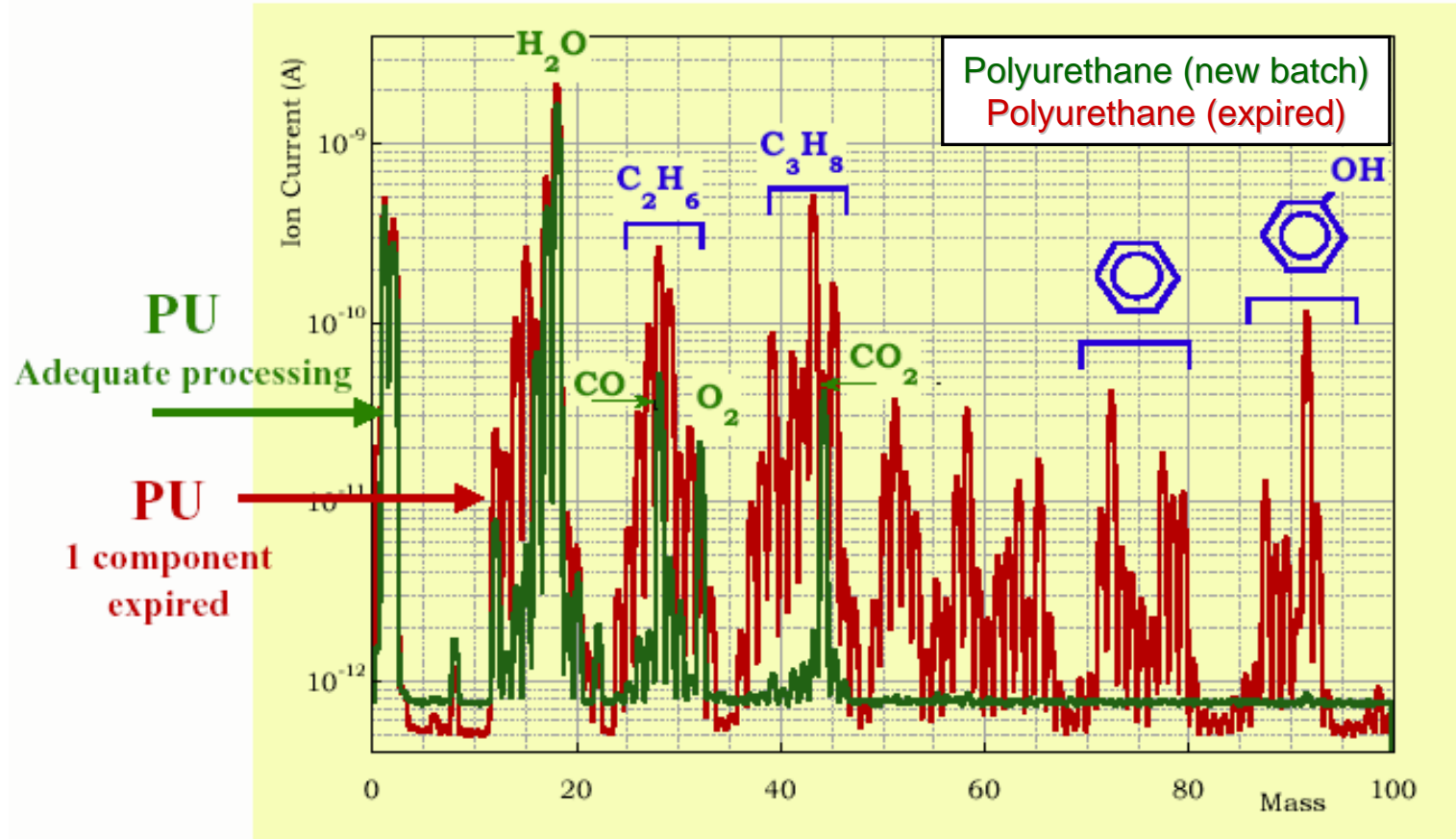

C.Bellachio, E.Broilo, P.Chiggiato, M.V.Stenis
CERN

(F. Sauli - Aging Workshop 2001, DESY)

Comparison of NASA, Chromatography and Aging Test results

SAMPLE	NASA	GC	Ageing test
Stycast 1266	BAD	OK	OK
Araldite 103	BAD	OK	OK
Araldite 106	BAD	BAD	BAD
Eccobond 285	OK	OK	OK
Nuvovern LW PUR	OK	OK	OK
ULTEM	OK	OK	OK
VECTRA 150	OK	OK	OK
Kalrez	OK	OK	OK
Epotek 905	BAD	BAD	
Dow Corning RTV	BAD	BAD	

Both used for
detector construction

Even if outgassing is detected, it might not be harmful
for the gaseous detector
!!! You have to do tests to match your specific requirements