

DataGRID

EDG TUTORIAL

HANDOUTS FOR PARTICIPANTS FOR EDG RELEASE 2.X

Document identifier:	DataGrid-08-TUT-V3.2.1
EDMS id:	
Date:	December 10, 2003
Work package:	EDG Collaboration
Partner(s):	EDG Collaboration
Lead Partner:	EDG
Document status:	Version 3.2.1
Author(s):	Flavia Donno, Leanne Guy, Mario Reale, Ricardo Rocha, Elisabetta Ronchieri, Massimo Sgaravatto, Heinz & Kurt Stockinger, Antony Wilson
File:	edg-tutorial-handout

Abstract: These handouts are provided for people to learn how to use the EDG middleware components to submit jobs on the Grid, manage data files and get information about their jobs and the testbed. It is intended for people who have a basic knowledge of the Linux/UNIX operating system and know basic text editor and shell commands.

CONTENTS

1. INTRODUCTION	5
1.1. OVERVIEW	5
1.2. EXERCISES AND DOCUMENTATION	5
1.3. GETTING A PROXY - BASICS OF GRID SECURITY	5
1.4. EXAMPLES	6
1.4.1. GRID-PROXY-INIT	6
1.4.2. GRID-PROXY-INFO	6
1.4.3. GRID-PROXY-DESTROY	6
1.5. GETTING THE EXERCISES	6
2. JOB SUBMISSION EXERCISES	8
2.1. EXERCISE JS-1: "HELLO WORLD"	8
2.2. EXERCISE JS-2: LISTING CONTENT OF CURRENT DIRECTORY ON THE WORKER NODE - GRID-MAP FILE	10
2.3. EXERCISE JS-3: A SIMPLE PAW PLOT	12
2.4. EXERCISE JS-4: PING OF A GIVEN HOST FROM THE WORKER NODE	14
2.5. EXERCISE JS-5: RENDERING OF SATELLITE IMAGES: USING DEMTOOLS	16
2.6. EXERCISE JS-6: USING POVRAY TO GENERATE VISION RAY-TRACER IMAGES	18
2.7. EXERCISE JS-7: GENERATE AN ALICE GEANT3 ALIROOT SIMULATED EVENT	20
2.8. EXERCISE JS-8: CHECKSUM ON A LARGE FILE TRANSFERRED WITH THE INPUTSANDBOX	22
2.9. EXERCISE JS-9: A SMALL CASCADE OF "HELLO WORLD" JOBS	24
2.10. EXERCISE JS-10: A SMALL CASCADE OF ALICE ALIROOT MC EVENTS JOBS	25
2.11. EXERCISE JS-11: TAKING A LOOK AT THE .BROKERINFO FILE	27
2.12. EXERCISE JS-12: A SIMPLE EXAMPLE OF AN INTERACTIVE JOB	29
2.13. EXERCISE JS-13: EXECUTION OF PARALLEL JOBS	30
2.14. EXERCISE JS-14: JOB CHECKPOINTING EXAMPLE	31
3. DATA MANAGEMENT EXERCISES	37
3.1. EXERCISE DM-1: DISCOVER GRID STORAGE	38
3.2. EXERCISE DM-2: START USING THE EDG REPLICATOR MANGER	40
3.3. EXERCISE DM-3: FILE REPLICATION WITH THE EDG REPLICATOR MANGER	42
3.3.1. ADVANCED EXERCISE - USING A STATIC CONFIGURATION FILE FOR INFORMATION SERVICE	43
3.4. EXERCISE DM-4: USING THE REPLICATOR CATALOG	45
3.5. EXERCISE DM-5: REPLICATOR OPTIMISATION WITH THE EDG REPLICATOR MANAGER	47
3.6. EXERCISE DM-6: USING THE REPLICATOR LOCATION SERVICE	50
3.7. EXERCISE DM-7: USING THE REPLICATOR METADATA CATALOG	53
3.8. EXERCISE DM-8: USING THE EDG REPLICATOR MANAGER WITHIN A JOB	55

3.9.	EXERCISE DM-9: USE CASE - READ DATA ON THE GRID	57
3.9.1.	PRE-USE CASE STEPS	57
3.9.2.	USE CASE STEPS	57
3.10.	EXERCISE DM-10: USE CASE - COPY AND REGISTER JOB OUTPUT DATA	58
3.11.	EXERCISE DM-11: USE CASE - BULK DATA REGISTRATION	59
4.	INFORMATION SERVICE EXERCISES	60
4.1.	EXERCISE IS-1: WITH THE AID OF THE COMMAND LINE TOOL DISCOVER WHAT COMPUTING ELEMENTS ARE AVAILABLE ON THE TESTBED	60
4.2.	EXERCISE IS-2: DISCOVER THE AVAILABLE STORAGE ELEMENTS	60
4.3.	EXERCISE IS-3: EMULATE THE RESOURCE BROKER	60
4.4.	EXERCISE IS-4: FIND OUT WHICH ARE THE RELATED STORAGE ELEMENTS . .	60
4.5.	EXERCISE IS-5: AVAILABLE SPACE ON THE STORAGE ELEMENT	61
4.6.	EXERCISE IS-6: JOINS	61
4.7.	EXERCISE IS-7: R-GMA BROWSER	61
4.8.	EXTRACT FROM THE USERS GUIDE - STREAMPRODUCER	62
5.	APPENDIX: ALTERNATIVE INFORMATION SERVICE: MDS	64
6.	GLOSSARY	66
6.1.	FILE NAMING CONVENTIONS	66
6.2.	ABBREVIATIONS AND EXPLANATIONS	67

Document Change Record

Issue	Date	Comment	Author
1_0	24 June 2003	start writing new DM exercises	Kurt Stockinger
1.1	25 June 2003	more exercises added for DM; job submission partly adapted to EDG release 2	Heinz & Kurt Stockinger
1.1.1	26 June 2003	more exercises added for DM	Heinz & Kurt Stockinger, Leanne Guy
1.2	7 July 2003	JS examples adapted to release 2.0; exercises 12 and 13 added	Ricardo Rocha
1.3	9 July 2003	IS exercises added	Antony Wilson
1.4	15 July 2003	JS exercise 14 added, some modifications DM exercise 8	Ricardo Rocha
3.2	24 November 2003	small corrections to JS and DM exercises; source code for JS 14 added	Heinz Stockinger
3.2.1	10 December 2003	small corrections to JS-9	Heinz Stockinger

1. INTRODUCTION

1.1. OVERVIEW

This document leads you through a number of increasingly sophisticated exercises covering aspects of job submission, data management and information systems.

It is assumed that you are familiar with the basic Linux/UNIX user environment (bash, shell etc.) and that you have obtained a security certificate providing access to the EDG testbed.

This document is designed to be accompanied by a series of presentations providing a general overview of Grids and the EDG tools.

Solutions to all the exercises are available online.

We do not give exact hostnames of machines in the testbed since they change over time. However, please refer to the EDG tutorial web-page to get the exact machine names that you require for your tutorial session.

1.2. EXERCISES AND DOCUMENTATION

In this document, you will find exercises on the following three topics: Job Submission, Data Management and Information Services. You will use several different Grid tools and you will sometimes need to consult the documentation of the tools you use. Here you find several hints how to find more detailed documentation.

- **Workload Management Software Administrator and User Guide, Job Description Language (JDL), Broker Info API/CLI):**

<http://server11.infn.it/workload-grid/documents.html>

- **EDG Replica Manager, Replica Location Service, Replica Metadata Catalog:**

<http://cern.ch/edg-wp2/replication/documentation.html>

- **Replica Optimization Service**

<http://cern.ch/edg-wp2/optimization/documentation.html>

1.3. GETTING A PROXY - BASICS OF GRID SECURITY

Once you have a certificate, you can request a ticket to be allowed to do the exercises that are given in this manual. The ticket you receive will be valid for several hours, long enough for a hands-on afternoon at least.

First, you have to get onto a machine that understands Grid commands. Such computers are called the User Interface (UI) machines and you may have one in your own home institute for which you have an account. If so, you can use this machine. Your instructor will tell you which machine and account you can use and what your password is.

Now one can get a ticket that allows you to use the testbed. The following commands are available:

- `grid-proxy-init` to get a ticket, a pass phrase will be required

- `grid-proxy-info -all` gives information of the ticket in use
- `grid-proxy-destroy` destroys the ticket for this session
- `grid-proxy-xxx -help` shows the usage of the command `grid-proxy-xxx`

1.4. EXAMPLES

1.4.1. GRID-PROXY-INIT

```
[bosk@testbed010 bosk] grid-proxy-init
Your identity: /O=dutchgrid/O=users/O=nikhef/CN=Kors Bos
Enter GRID pass phrase for this identity:
Creating proxy ..... Done
Your proxy is valid until Thu Sep  5 21:37:39 2002
```

1.4.2. GRID-PROXY-INFO

```
[bosk@testbed010 bosk] grid-proxy-info -all
subject  : /O=dutchgrid/O=users/O=nikhef/CN=Kors Bos/CN=proxy
issuer   : /O=dutchgrid/O=users/O=nikhef/CN=Kors Bos
type     : full
strength : 512 bits
<timeleft : 11:59:43
```

1.4.3. GRID-PROXY-DESTROY

```
[bosk@testbed010 bosk] grid-proxy-destroy -dryrun
```

Would remove the file `/tmp/x509up_uUID` where your proxy is stored. Note that the proxy file `/tmp/x509up_uUID` depends on your UNIX User ID (UID) and thus if your UID is 2899, the proxy file is called: `/tmp/x509up_u2899`.

1.5. GETTING THE EXERCISES

Now you are logged onto the testbed and have a ticket, you can start to run some. Some material for the exercises has been prepared in advance and you can copy it (e.g. with `wget`) to your home directory on the UI machine from:

```
http://cern.ch/hep-proj-grid-tutorials/jobsubmission-2.tar.gz
```

Example of what you may see on the screen:

```
[bosk@testbed010 temp] wget http://cern.ch/hep-proj-grid-tutorials/jobsubmission-2.tar.gz
http://cern.ch:80/hep-proj-grid-tutorials/jobsubmission-2.tar-gz
=> 'jobsubmission.tgz'
```

```
Connecting to hep-proj-grid-tutorials.web.cern.ch:80... connected!
HTTP request sent, awaiting response... 200 OK
Length: 2,031,924 [application/x-compressed]
OK -> ..... [ 2%]
```

```
50K -> ..... [ 5%]  
1900K -> ..... [ 98%]  
1950K -> ..... .. [100%]  
11:31:45 (9.55 MB/s) - `jobsubmission.tgz' saved [2031924/2031924]
```

2. JOB SUBMISSION EXERCISES

2.1. EXERCISE JS-1: "HELLO WORLD"

Goal: In this example we do the simplest job submission to the Grid. We will involve the basic components of the Workload Management System (WMS). Namely, we will submit a job which simply prints "Hello World", using the `/bin/echo` command and takes the "Hello World" string as an argument to this command.

A simplified version of the Workload Management System (WMS) and involved components is shown in Figure 1. The following main components are involved:

- User Interface (UI)
- Workload Management System (WMS) components (including. a Network Server, Resource Broker, Job Controller etc. ¹).
- Computing Element (CE) with the Globus Gatekeeper (GK) and the Local Resource Management System (LRMS),
- Worker Node (WN)
- Logging and Bookkeeping (LB) system

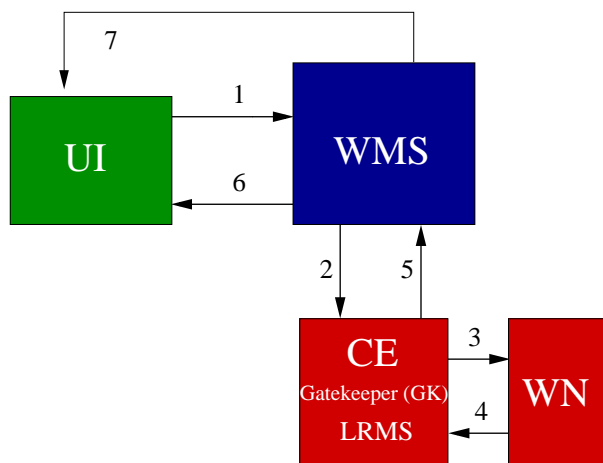

Figure 1: The main WMS components and their operation

Users access the Grid through the User Interface machine, which by means of a set of binary executables written in Python, allows us to submit a job, monitor its status and retrieve its output. The job will execute on the Worker Node but the output can be displayed and stored on the UI machine.

To do so, we write a simple JDL (Job Description Language) file and issue the command

```
edg-job-list-match <JDL-file-name>
```

to check which are the available computing elements to execute the job. We submit it to the Grid by means of the following command:

¹For architectural details please refer to the User Guide or to the slides in the Job Submission talk of the EDG Tutorial

```
edg-job-submit <JDL-file-name>
```

The system should accept our job and return a unique job identifier (*JobId*).

We verify the status of the execution of the job using

```
edg-job-status <JobId>
```

After the jobs gets into the *Done (Success)* status, we retrieve the output by issuing

```
edg-job-get-output <JobId>
```

Next, we verify that the output file is in the corresponding local temporary directory on the user interface and that no errors occurred.

Figure 1 shows the complete sequence of operations performed, after having compiled the JDL file and having verified the availability of matching computing elements. The numbers below correspond to the numbers in Figure 1:

- User submits the job from the UI to the WMS. (1)
- The WMS (in particular the Resource Broker) performs the matchmaking to find the best available CE to execute the job.
- The WMS first prepares the job which includes the creation of a RSL (Resource Specification Language) file to submit to the Local Resource Management System (LRMS or batch system such as LSF, PBS, etc). The WMS then transfers the job (and files specified in the *InputSandbox*) to the Globus Gatekeeper (GK). (2)
- The Gatekeeper sends the Job to the LRMS, which handles the job execution on the available local farm worker nodes. (3)
- After the execution on the WN, the produced output is transferred back to the WMS and to the UI, using the *OutputSandbox*. (4), (5), (6)
- Queries of the job status are addressed to the logging and bookkeeping database (part of the WMS) from the UI machine. (7)

The JDL file, we will be using, is the following one:

```
Executable      = "/bin/echo";
Arguments       = "Hello World";
StdOutput       = "message.txt";
StdError        = "stderr";
OutputSandbox   = {"message.txt", "stderr"};
```

The issued command sequence will be:

```
grid-proxy-init
edg-job-submit HellowWorld.jdl
edg-job-status JobId
edg-job-get-output JobId
```

2.2. EXERCISE JS-2: LISTING CONTENT OF CURRENT DIRECTORY ON THE WORKER NODE - GRID-MAP FILE

Goal: In this example we will list the files on the local directory of the Worker Node.

Every user is mapped onto a local user account on the various Computing Elements all over the Grid. This mapping is controlled by the `/etc/grid-security/grid-mapfile` file on the Gatekeeper machine and is known as the *grid-mapfile mechanism*: every user (identified by their personal certificate's subject) must be listed in the *grid-mapfile* file and associated to one of the pooled accounts available on the CE for the locally supported Virtual Organization he belongs to (see Figure 2).

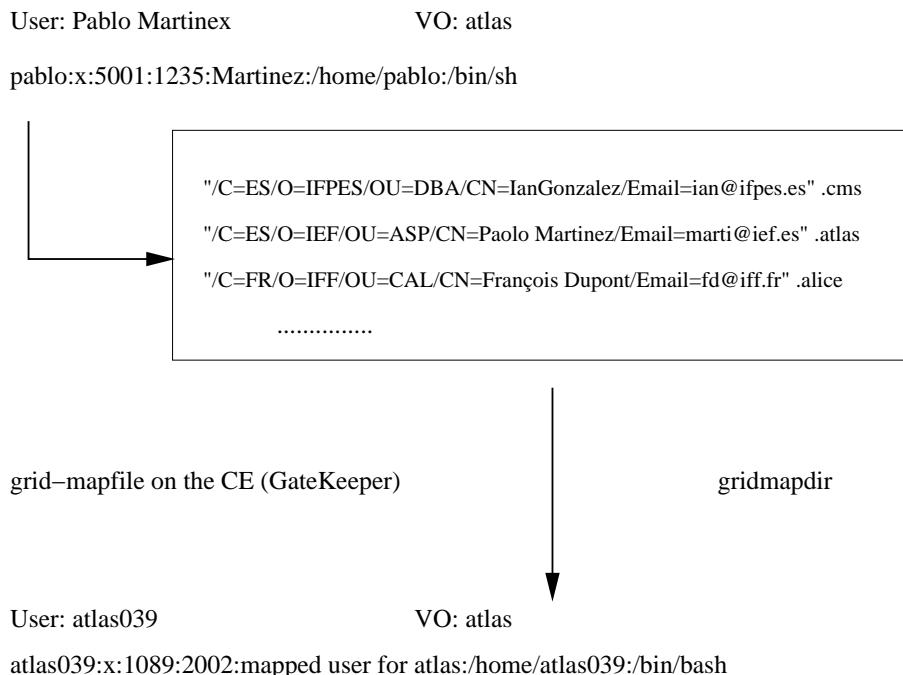

Figure 2: The grid-mapfile mechanism

The *grid-mapfile* mechanism, which is part of GSI, requires that each individual user on the Grid is assigned to a unique local User ID. The *accounts leasing* mechanism allows access to take place without the need for the system manager to create an individual user account for each potential user on each computing element.

On their first access to a Testbed site, users are given a temporary "leased" identity (similar to temporary network addresses given to PCs by the DHCP mechanism). This identity is valid for the task duration and need not to be freed afterwards. If the lease still exists when the user reenters the site, the same account will be reassigned to him.

(See <http://www.gridpp.ac.uk/gridmapdir/>)

We therefore submit here (after `grid-proxy-init`) a job using the executable `/bin/ls`, and we redirect the standard output to a file (JDL attribute: `Stdoutput = "ListOfFiles.txt"`);, which is retrieved via the *OutputSandbox* to a local directory on the User Interface machine. The result of the file listing command will be the list of files on the \$HOME directory of the local user account on the Worker Node to which we are mapped. We can issue `edg-job-submit JobId` and `edg-job-get-output JobId` (after the job is in the Done (Success) status) to get the output.

The exercise is finished at this point.

BACKGROUND INFORMATION ON SECURITY

You are not asked to print the grid-mapfile. It is mentioned here for your information and knowledge.

This very basic example shows how accessing Grid resources is guaranteed only to certified users, with a valid PKI X.509 personal certificate (issued by an officially recognized Certification Authority), whose certificate's subject is listed in the grid-mapfile of the various CE resources, distributed all over the Grid.

To store all subjects of the certificates belonging to the large community of users, each virtual Organization manages an LDAP Directory server, describing its members. Each user entry of this directory contains at least the URL of the certificate on the Certification Authority LDAP Server and the Subject of the user's certificate, in order to make the whole process faster.

Moreover, EDG must sign the Acceptable Use Policy (AUP) document in order to receive a certificate and there is another LDAP Directory ("Authorization Directory") which collects the names of people who have signed the AUP. The *grid-mapfile* file on the various Grid CEs is generated by a daemon called *mkgridmap*, which contacts these LDAP servers (the VO-Authentication server, which will at its turn contact the Certification Authority LDAP server) and the Authorization Directory server, to locally generate (normally once per day) a locally updated version of the */etc/grid-security/grid-mapfile* file. This mechanism is represented in Figure 3.

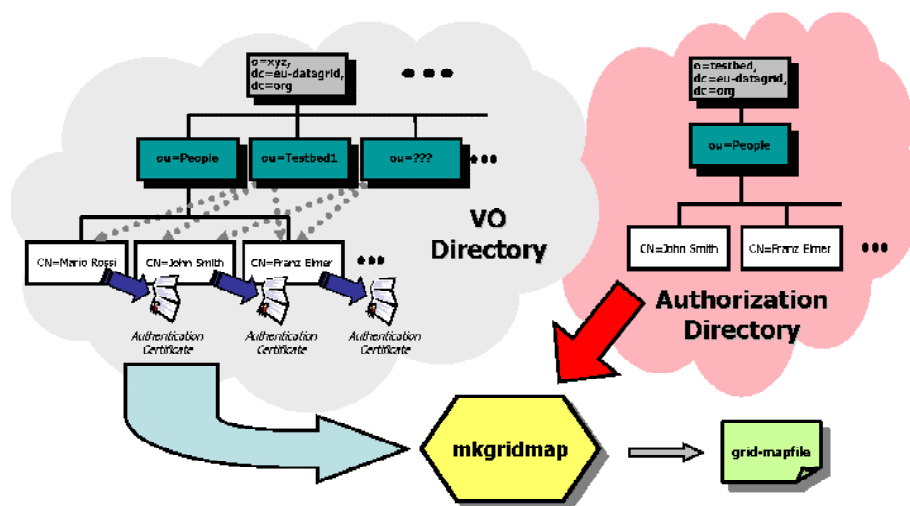

Figure 3: The mkgridmap daemon, updating the grid-mapfile file

2.3. EXERCISE JS-3: A SIMPLE PAW PLOT

Goal: In this exercise we execute a simple plot on the Grid using PAW, the Physics Analysis Workstation package belonging to the CERNLIB libraries.

The PAW executable is installed under the `/cern/pro/bin` directory. We will run PAW in its batch mode, passing as an argument to the executable the `"-b testgrid"` string, which tells PAW to execute in batch a macro of instructions called `testgrid.kumac`.

`testgrid.kumac` opens a file for output in the postscript format and stores the drawing of the components of a previously created simple vector:

```
ve/create a(10) r 1 2 3 8 3 4 5 2 10 2
ve/print a
for/file 1 testgrid.ps
metafile -1 -111
ve/draw a
close 1
```

Another macro file called `pawlogon.kumac` sets the PAW environment and options for a given user: in this case the date on the plots.

The produced output file is therefore `testgrid.ps`, which, after the Job Output retrieval, can be viewed using `ghostview`.

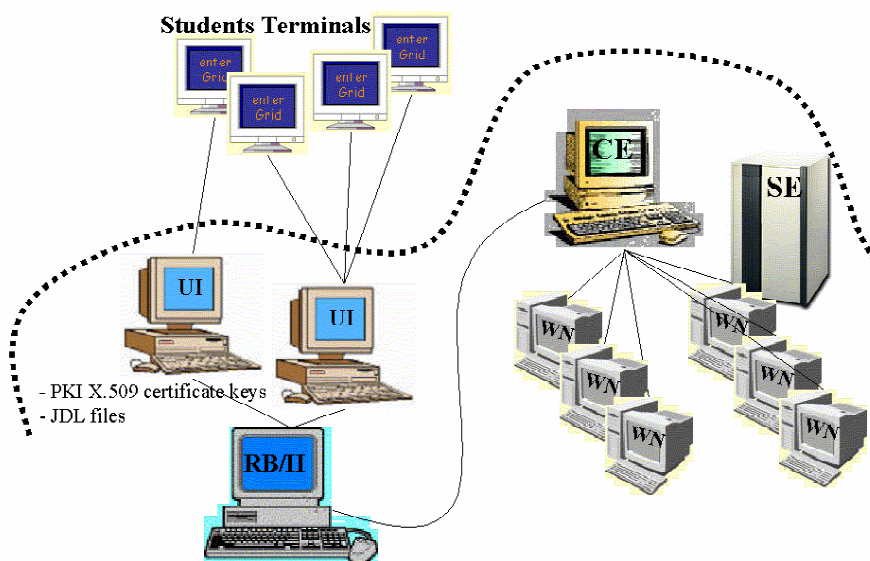

Figure 4: The main Grid components involved in the execution of a simple PAW plot

The two required `.kumac` files are stored locally on our UI machine and need to be transferred to the Worker Node via InputSandbox. When the Job has finished, we can retrieve the produced output file, together with the standard error and standard output file via the OutputSandbox.

Therefore the JDL file (`pawplot.jdl`) we are going to use looks like this:

```
Executable      = "/cern/pro/bin/paw";
Arguments       = "-b testgrid";
StdOutput       = "stdout";
StdError        = "stderr";
InputSandbox    = {"testgrid.kumac", "pawlogon.kumac"};
OutputSandbox   = {"stderr", "stdout", "testgrid.ps"};
```

We will submit this job twice: once to the Broker, leaving it the task of performing the matchmaking process to find the best matching CE, and once directly to an available CE (we get the list of available CEs using the `edg-job-list-match` command).

The sequence of commands we are going to issue is:

```
grid-proxy-init
edg-job-submit pawplot.jdl
edg-job-status JobId1
edg-job-get-output JobId1
edg-job-list-match pawplot.jdl
edg-job-submit -resource CEid pawplot.jdl
edg-job-status JobId2
edg-job-get-output JobId2
```

Figure 4 shows the main Grid elements involved in this job's execution example.

2.4. EXERCISE JS-4: PING OF A GIVEN HOST FROM THE WORKER NODE

Goal: In this example we run the simple ping of a remote host from the Worker Node, to start understand the execution of simple commands on the worker nodes. We will execute a ping to a given host from the Worker Node in two ways: directly calling the `/bin/ping` executable on the machine and writing a very simple shell script (`pinger.sh`) which does it for us, just to understand how to use shell scripts on the Grid.

We need therefore to write two different JDL files and submit them.

In the first case we directly call the ping executable (JDL file is `pinger1.jdl`):

```
Executable      = "/bin/ping";
Arguments       = "-c 5 lxshare0220.cern.ch";
RetryCount      = 7;
StdOutput       = "pingmessage1.txt";
StdError        = "stderr";
OutputSandbox   = {"pingmessage1.txt", "stderr"};
Requirements    = other.GlueHostOperatingSystemName == "Redhat";
```

Whereas in the second case we call the bash executable to run a shell script, giving as input argument both the name of the shell script and the name of the host to be pinged (as required by the shell script itself) (JDL file is `pinger2.jdl`):

```
Executable      = "/bin/bash";
Arguments       = "pinger.sh lxshare0220.cern.ch";
RetryCount      = 7;
StdOutput       = "pingmessage2.txt";
StdError        = "stderr";
InputSandbox    = "pinger.sh";
OutputSandbox   = {"pingmessage2.txt", "stderr"};
Requirements    = other.GlueHostOperatingSystemName == "Redhat";
```

where the `pinger.sh` shell script, to be executed in bash, is the following one:

```
#!/bin/bash
/bin/ping -c 5 $1
```

As a related problem, try to build similar examples for `/bin/pwd` or `/usr/bin/who`, in both ways: directly and via a shell script. As usual, the set of commands we are going to issue in both cases is the following one (of course changing the name of the JDL from `pinger1.jdl` to `pinger2.jdl` in the second case):

```
grid-proxy-init
edg-job-submit pinger1.jdl
edg-job-status JobId
edg-job-get-output JobId
```

The main difference between the two ways of operating are summarized below, and it suggests a third one:

JDL file - 1

```

Executable = "/bin/ping";
Arguments  = "-c 5 lxshare0393.cern.ch";
    
```

JDL file - 2

```

Executable   = "/bin/bash";
Arguments    = "pinger.sh lxshare0393.cern.ch";
InputSandbox = "pinger.sh";
    
```

JDL file - 3 There is a third way of executing the ping command: directly calling the pinger shell script as executable.

```

Executable   = "pinger.sh";
Arguments    = "lxshare0393.cern.ch";
InputSandbox = "pinger.sh";
    
```

2.5. EXERCISE JS-5: RENDERING OF SATELLITE IMAGES: USING DEMTOOLS

Please note that this exercise can only be executed if the DEMTOOLS software is installed on at least one available Computing Element. Since this software is not strictly related to the on going production activities, it may unfortunately happen that it occasionally will not be available.

Therefore, please check, before trying to start the exercise, that at least one CE fits the requirements of the exercise, and issue a `edg-job-list-match demtools.jdl` to make sure it can be executed, otherwise please skip this exercise.

In addition, after execution, a visualization tool called `lookat` is required to visualize the produced graphical file in output. If this tool is not installed on the UI machine you are using (usually under `/usr/local/bin/lookat`) you will not be able to look at the produced output file. Cross-check this with the available tutors during the tutorials.

We will launch the DEMTOOLS program on the Grid, which is a satellite images rendering program: starting from ASCII files in the .DEM format (Digital Elevation Model, usually acquired by high resolution remote sensing satellites), produces graphical virtual reality images, in the .wrl file format, which can then be browsed and rotated using the `lookat` command, after output retrieval.

We need to specify in input the satellite remote sensing data stored in the 2 files, referring to satellite views of Mont Saint Helens and the Grand Canyon, called `mount_sainte_helens_WA.dem` and `grand_canyon_AZ.dem`, and after the job's execution we need to specify the name of the 2 produced images we want returned to our UI machine. The data flow is shown in Figure 5.

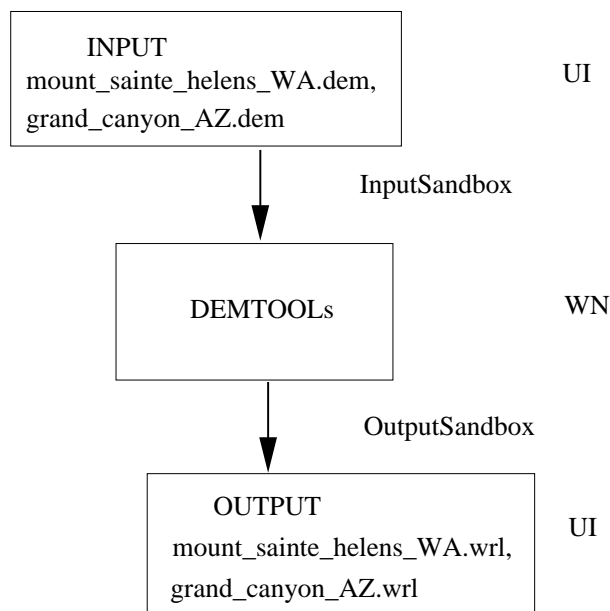

Figure 5: Data Flow for example exercise JS-5 on DEMTOOLS

The JDL file (`demtools.jdl`) is the following one:

```
Executable = "/bin/sh";
```



```

StdOutput      = "demtools.out";
StdError       = "demtools.err";
InputSandbox   = {"start_demtools.sh",
                  "mount_sainte_helens_WA.dem",
                  "grand_canyon_AZ.dem"};
OutputSandbox  = {"demtools.out",
                  "demtools.err",
                  "mount_sainte_helens_WA.ppm",
                  "mount_sainte_helens_WA.wrl",
                  "grand_canyon_AZ.ppm",
                  "grand_canyon_AZ.wrl"};
RetryCount     = 7;
Arguments      = "start_demtools.sh";
Requirements   = Member("DEMTOOLS",other.GlueHostApplicationSoftwareRunTimeEnvironment);
    
```

Note that we need to expressly require that the destination CE should have the DEMTOOLS software installed: we do so in the last line of the JDL file.

The launching shell script (*start_demtools.sh*) used is the following one:

```

/usr/local/bin/dem2ppm mount_sainte_helens_WA.dem \
    mount_sainte_helens_WA.ppm
/usr/local/bin/dem2vrml -r 2 mount_sainte_helens_WA.dem \
    mount_sainte_helens_WA.wrl}
/usr/local/bin/dem2ppm grand_canyon_AZ.dem \
    grand_canyon_AZ.ppm}
/usr/local/bin/dem2vrml -r 2 grand_canyon_AZ.dem \
    grand_canyon_AZ.wrl
    
```

To check the effective presence of available CEs for the job to be correctly executed, as usual, we can issue a `edg-job-list-match demtools.jdl`. After we checked (issuing a `edg-job-status JobId`) that the Job reached the `OutputReady` status, we can issue a `edg-job-get-output JobId` to retrieve the output locally on the User Interface machine and take a look at the produced images going in the local directory where the output has been returned using `lookat grand_canyon_AZ.wrl` and `lookat mount_sainte_helens_WA.wrl`.

Finally, to visualize the produced graphical output file, we can issue:

```
lookat grand_canyon_AZ.wrl
```

2.6. EXERCISE JS-6: USING POVRAY TO GENERATE VISION RAY-TRACER IMAGES

Please note that this exercise can only be done if the POVRAY software is installed on at least one available Computing Element. Before you start the exercise, therefore please make sure that the software is actually available (using the command `dg-job-list-match povray_pipe.jdl`)

We want to launch POVRAY (<http://povray.org>), a graphical program, which starting from ASCII files (in this specific example - the *pipeset.pov* file) in input, creates in output Vision Ray-Tracer images in the .png file format.

We will do it using the Grid, submitting a proper JDL file which executes an ad-hoc shell script file. In this example the outgoing image is the one of a pipe duct.

We need therefore to compile our JDL file, specifying in the InputSandbox all the required ASCII files to be used by the program and the corresponding shell script. Then we submit it to the WMS system.

The executable to be used in this case is the sh shell executable, giving as an input argument to it the name of the shell script we want to be executed (*start_povray_pipe.sh*):

```
#!/bin/bash
mv pipeset.pov OBJECT.POV
/usr/local/bin/x-povray /usr/local/lib/povray31/res640.ini
mv OBJECT.png pipeset.png
```

We can finally, after having retrieved the Job, examine the produced image using Netscape or Explorer or using *xv* (after having exported the \$DISPLAY variable to our current terminal).

The JDL file we are going to use is the following one (*povray_pipe.jdl*):

```
Executable      = "/bin/sh";
StdOutput       = "povray_pipe.out";
StdError        = "povray_pipe.err";
InputSandbox    = {"start_povray_pipe.sh", "pipeset.pov"};
OutputSandbox   = {"povray_pipe.out",
                  "povray_pipe.err",
                  "pipeset.png"};
RetryCount      = 7;
Arguments       = "start_povray_pipe.sh";
Requirements    = Member("POVRAY-3.1", other.GlueHostApplicationSoftwareRunTimeEnvironment);
```

Since we require a special software executable (*/usr/local/bin/x-povray/usr/local/lib/povray3/res640.ini*), which is identified by the Grid Run Time Environment tag called "POVRAY-3.1", we notice here that we need to specify it in the Requirements classAd, in order to consider (during the matchmaking done by the Broker to select the optional CE to send the job to) only those CEs which have this software installed. This is done in the last line of the JDL file.

The set of sequence commands we are going to issue is the following one:

```
grid-proxy-init
edg-job-list-match povray_pipe.jdl
edg-job-submit povray_pipe.jdl
edg-job-status JobId
edg-job-get-output JobId
```

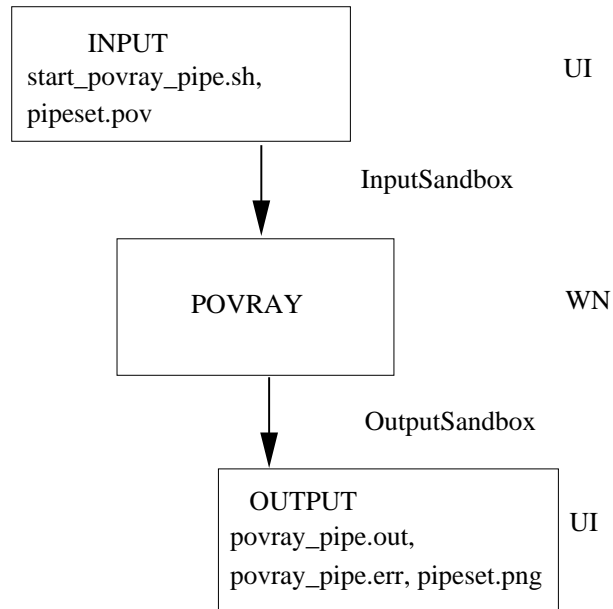

Figure 6: Data Flow for example exercise JS-6 on POV-Ray

The data flow via Input and Output Sandboxes for this exercise is shown in Figure 6. To take a look at the produced file look at *pipeset.png* using *xview* : issue `xv pipeset.png` or `xview pipeset.png` .

2.7. EXERCISE JS-7: GENERATE AN ALICE GEANT3 ALIROOT SIMULATED EVENT

Goal: We are going to generate an ALICE (<http://alice.web.cern.ch/Alice>) simulated event on the Grid.

The event is a reduced track number Lead-Lead collision, and it is generated by Aliroot⁽²⁾, which is a GEANT 3 based generator for MonteCarlo simulated events.

We write therefore a JDL file using the `/bin/bash` executable passing as argument the name of the script we want to execute. This script basically sets some environmental variables and then launches Aliroot with an appropriate configuration file. We will need to transfer all required files to the WN, therefore filling them in the InputSandbox. We will then retrieve the output and check the correct presence of the files in output, and take a look at the produced event running Aliroot in the Display mode. The required shell script to be used sets some relevant environment variables and renames one file (`rootrc`) for Aliroot; then it starts the Aliroot programs, “compiling on the flight” the file `grun.C` and initially generating the event, in the `galice.root` file.

```
#!/bin/sh
mv rootrc $HOME/.rootrc
echo "ALICE_ROOT_DIR is set to $ALICE_ROOT_DIR"
export ROOTSYS=$ALICE_ROOT_DIR/root/$1
export PATH=$PATH:$ROOTSYS/bin
export LD_LIBRARY_PATH=
    $ROOTSYS/lib:$LD_LIBRARY_PATH
export ALICE=$ALICE_ROOT_DIR/aliroot
export ALICE_LEVEL=$2
export ALICE_ROOT=$ALICE$ALICE_LEVEL
export ALICE_TARGET=`uname`
export LD_LIBRARY_PATH=
    $ALICE_ROOT/lib/tgt_$ALICE_TARGET:$LD_LIBRARY_PATH
export PATH=
    $PATH:$ALICE_ROOT/bin/tgt_$ALICE_TARGET:$ALICE_ROOT/share
export MANPATH=$MANPATH:$ALICE_ROOT/man
$ALICE_ROOT/bin/tgt_$ALICE_TARGET/aliroot -q -b grun.C
```

The JDL file we need is the following one:

```
Executable      = "/bin/sh";
StdOutput       = "aliroot.out";
StdError        = "aliroot.err";
InputSandbox    = {"start_aliroot.sh",
                  "rootrc",
                  "grun.C",
                  "Config.C"};
OutputSandbox  = {"aliroot.out",
                  "aliroot.err",
                  "galice.root"};
RetryCount      = 7;
Arguments       = "start_aliroot.sh 3.02.04 3.07.01";
Requirements    = Member("ALICE-3.07.01",other.GlueHostApplicationSoftwareRunTimeEnvironment);
```

²<http://alisoft.cern.ch/offline/aliroot-new/howtorun.html>

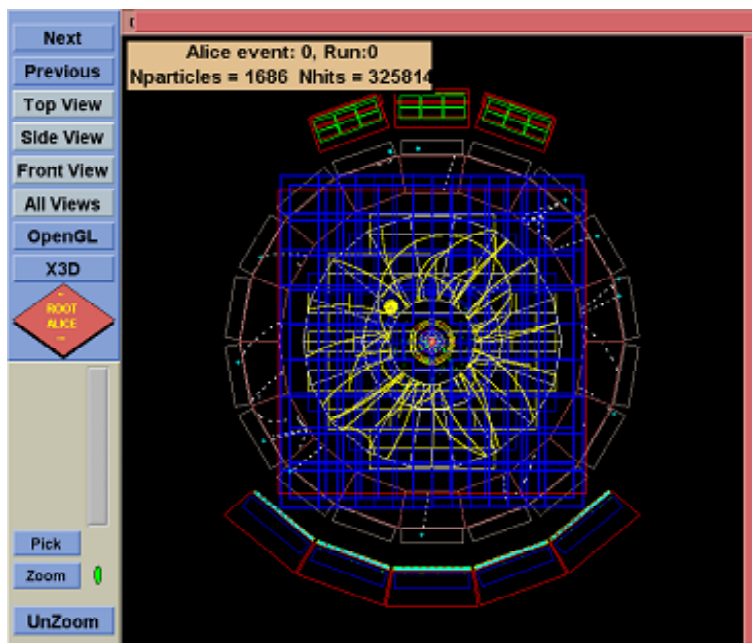

Figure 7: The ALICE Aliroot GEANT 3 simulated event

Note that the following part of the exercise (displaying the event) can only be executed if aliroot is installed locally on your User Interface machine (UI). Please check that or ask your tutor for help.

After output retrieval, we can take a look at the event launching Aliroot in the Display mode by issuing *aliroot display.C*, after having copied the *rootrc* file to our home directory, having renamed it to *.rootrc* and having sourced the *aliroot.sh* file. The generated event looks like the one reported in Figure 7.

Figure 8 reports the data flow (Input/Output) for this aliroot example run.

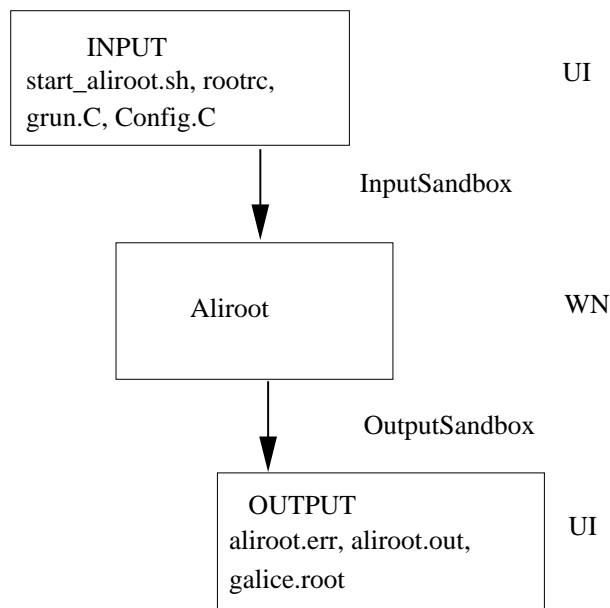

Figure 8: Input/Output data flow to the Worker Node for the generation of an ALICE simulated event

2.8. EXERCISE JS-8: CHECKSUM ON A LARGE FILE TRANSFERRED WITH THE INPUTSANDBOX

Goal: In this example exercise we transfer via InputSandbox a large file (file size about 200 MB), whose bit wise checksum is known, and check that the file transfer did not corrupt by any mean the file by performing again the checksum on the Worker Node and comparing the two results.

We will use a shell script (*ChecksumShort.sh*), which exports in an environmental variable (`$CSTRUE`) the value of the CheckSum for the file before file transfer, and then performs again the check locally on the Worker Node issuing the `cksum` command on the file *short.dat* and exporting the result in the `$CSTRUE` environmental variable. The test result is correct if the two values are equal:

```

#!/bin/sh
# The true value of the checksum
export CSTRUE="2933094182 1048576 short.dat"
# Create a 20MB file with the given seed
echo "True checksum: '${CSTRUE}'"
export CTEST="`cksum short.dat`"
echo "Test checksum: '${CTEST}'"
echo "Done checking"
if ["${CSTRUE}" = "${CTEST}"]; then
    export STATUS=OK;
else
    export STATUS=FAIL;
fi
# Finished
echo "Goodbye. [${STATUS}]"
  
```

The JDL file we are going to use is the following one (*ChecksumShort.jdl*):

```

Executable      = "ChecksumShort.sh";
StdOutput       = "std.out";
StdError        = "std.err";
InputSandbox    = {"ChecksumShort.sh", "short.dat"};
OutputSandbox  = {"std.out", "std.err"};
Arguments       = "none";
    
```

If everything works fine (and the GridFTP InputSandbox transfer was OK) in the *std.out* file we should find this content:

```

True checksum:'2933094182 1048576 short.dat'
Test checksum:'2933094182 1048576 short.dat'
Done checking.
Goodbye. [OK]
    
```

The data flow for this exercise is shown in Figure 9.

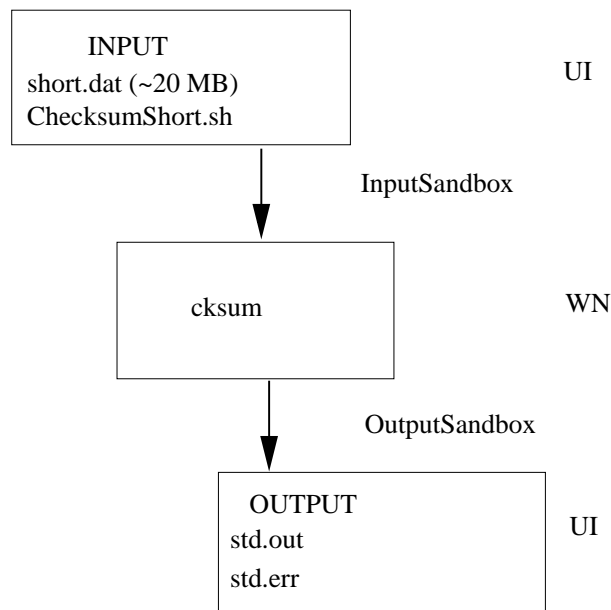

Figure 9: Checksum example data flow

As usual, the sequence of commands we are going to issue is the following one:

```

grid-proxy-init
edg-job-submit ChecksumShort.jdl
edg-job-status JobId
edg-job-get-output JobId
    
```

We finally need to change directory to the local directory where files have been retrieved and examine the *std.out* to check the result of the checksum test.

2.9. EXERCISE JS-9: A SMALL CASCADE OF "HELLO WORLD" JOBS

Goal: Goal of this exercise is to submit a small cascade of elementary "Hello World" jobs, to explore the tools provided to handle numerous JobIds during the parallel execution of a large set of Jobs.

For our purpose we can log in twice on the User Interface, in order to have at our disposal two simultaneous sessions from which to submit jobs.

We then use a shell script that loops a given amount of times submitting a single job each occasion (*submitter.sh*):

```
#!/bin/bash
i=0
while [ $i -lt $1 ]
do edg-job-submit -o $2 HelloWorld.jdl
  i=`expr $i +1`
done
```

From each UI session, after `grid-proxy-init`, we can issue the command:

```
./submitter.sh 4 HelloWorld.jobids}.
```

The ".jobids" file is a file containing all JobIds for the 4 submitted Jobs. This can be done using the "-o filename" option in the `edg-job-submit` command to submit jobs.

We can then use the provided shell script called *analysis.sh* (which requires in input the name of the .jobids file) to issue the `edg-job-status` for all jobs and extract in a formatted way some relevant information, storing it in the file *analizza.txt*. Otherwise we can also issue directly a `edg-job-status -i HelloWorld.jobids` to get info on the Job's status. To collectively retrieve the output we can issue a `edg-job-get-output -i HelloWorld.jobids` and then examine the content of the files on the local temporary directories on the UI, where files are retrieved. The JDL file we use is the simplest one of all:

```
Executable      = "/bin/echo";
StdOutput       = "message.txt";
StdError        = "stderr";
OutputSandbox  = {"message.txt", "stderr"};
Arguments       = "Hello World";
```

2.10. EXERCISE JS-10: A SMALL CASCADE OF ALICE ALIROOT MC EVENTS JOBS

Goal: The aim of this exercise is to submit a small cascade of Aliroot jobs to represent a mini production of ALICE simulated events on the Grid.

We will therefore use a submitter shell script, which will produce a loop in which the submission of the *aliroot.jdl* (see exercise JS-7) is performed.

Like in the previous exercise (JS-9), we will store all JobIds in a file (*aliroot.jobids*), and use this file to handle the jobs (getting their status and retrieving the output).

We run the *alirootSubmitter.sh* shell script, that will issue the `edg-job-submit -o aliroot.jobids` commands. We then monitor the status of the jobs using the *analysis.sh* script. After all jobs have been executed, we will issue a `edg-job-get-output -i aliroot.jobids` to retrieve the output of all the executed jobs. We require the presence of the ALICE Experiment Software installed on the Computing Element's Worker Nodes: this is done in the last line of the following JDL file (*aliroot.jdl*):

```
Executable      = "/bin/sh";
StdOutput       = "aliroot.out";
StdError        = "aliroot.err";
InputSandbox    = {"start_aliroot.sh",
                  "rootrc",
                  "grun.C",
                  "Config.C"};
OutputSandbox   = {"aliroot.out",
                  "aliroot.err",
                  "galice.root"};
RetryCount      = 7;
Arguments       = "start_aliroot.sh 3.02.04 3.07.01";
Requirements    = Member("ALICE-3.07.01",other.GlueHostApplicationSoftwareRunTimeEnvironment);
```

The corresponding shell script (*start_aliroot.sh*) is (like in exercise JS-7):

```
#!/bin/sh
mv rootrc $HOME/.rootrc
echo "ALICE_ROOT_DIR is set to $ALICE_ROOT_DIR"
export ROOTSYS=$ALICE_ROOT_DIR/root/$1
export PATH=$PATH:$ROOTSYS/bin
export LD_LIBRARY_PATH=
  $ROOTSYS/lib:$LD_LIBRARY_PATH
export ALICE=$ALICE_ROOT_DIR/aliroot
export ALICE_LEVEL=$2
export ALICE_ROOT=$ALICE/$ALICE_LEVEL
export ALICE_TARGET='uname`
export LD_LIBRARY_PATH=
  $ALICE_ROOT/lib/tgt_$ALICE_TARGET:$LD_LIBRARY_PATH
export PATH=
  $PATH:$ALICE_ROOT/bin/tgt_$ALICE_TARGET:$ALICE_ROOT/share
export MANPATH=$MANPATH:$ALICE_ROOT/man
$ALICE_ROOT/bin/tgt_$ALICE_TARGET/aliroot -q -b grun.C
```

and the *alirootSubmitter.sh* shell script is the following one:

```
#!/bin/bash
i=0
while [ $i -lt $1 ]
do edg-job-submit -o $2 aliroot.jdl
  i=`expr $i +1`
done
```

Finally, we need to issue from the User Interface machine the following commands to start the production:

```
grid-proxy-init
./alirootSubmitter.sh 5 aliroot.jobids
./analysis.sh aliroot.jobids
edg-job-get-output -i aliroot.jobids
```

2.11. EXERCISE JS-11: TAKING A LOOK AT THE .BROKERINFO FILE

Goal: In this exercise we learn how to use the `.BrokerInfo` file and corresponding tools to retrieve information about a job on a Worker Node.

When a Job is submitted to the Grid, we do not know a-priori its destination Computing Element.

There are reciprocal "closeness" relationships among Computing Elements and Storage Elements which are taken into account during the match making phase by the Resource Broker and affect the choice of the destination CE according to where required input data are stored.

For jobs which require accessing input data normally resident on a given Grid SE, the first part of the matchmaking is a query to the Replica Catalog to resolve each required LFN into a set of corresponding SURLS or physical locations. Once a set of job-accessible SEs is available, the matchmaking process selects the optimal destination CE - i.e. the "closest" to the most accessed Storage Element.

In general, we need a way to inform the Job of the choice made by the Resource Broker during the matchmaking so that the Job itself knows which are the physical files actually to be opened. Therefore, according to the actual location of the chosen CE, there must be a way to inform the job how to access the data.

This is achieved using a file called the `.BrokerInfo` file, which is written at the end of the matchmaking process by the Resource Broker and it is sent to the worker node as part of the `InputSandbox`.

The `.BrokerInfo` file contains all information relevant for the Job, like the destination CEId, the required data access protocol for each of the SEs needed to access the input data ("file" - if the file can be opened locally, "rfio" or "gridftp" - if it has to be accessed remotely, etc), the corresponding port numbers to be used and the physical file names (SURLS) corresponding to the accessible input files from the CE where the job is running.

The `.BrokerInfo` file provides to the application a set of methods to resolve the LFN into a set of possible corresponding SURLS (`getLFN2SFN`). **Note that by definition the SFN corresponds to an SURL but it does not contain the prefix "srm:". Neither the BrokerInfo API nor CLI distinguishes between SFN and SURL and thus they are identical here.**

In addition, there exists a Command Line Interface (CLI) called `edg-brokerinfo` that is equivalent to the C++ API. It can be used to get information on how to access data, compliant with the chosen CE. The CLI methods can be invoked directly on the Worker Node (where the `.BrokerInfo` file actually is held), and - similarly to the C++ API - do not actually re-perform the matchmaking, but just read the `.BrokerInfo` file to get the result of the matchmaking process. **Note that the CLI and the API can only be successfully used on the WN where the .BrokerInfo file exists. You will not be able to use the tool on the UI.**

In this example exercise we take a look at the `.BrokerInfo` file on the Worker Node of the destination CE, and examine its various fields.

The very basic JDL we are going to use is the following one (`brokerinfo.jdl`):

```
Executable      = "/bin/more";
StdOutput       = "message.txt";
StdError        = "stderr.log";
OutputSandbox  = {"message.txt", "stderr.log"};
Arguments       = " .BrokerInfo";
```

The corresponding set of commands we have to issue are as follows:

```
grid-proxy-init  
edg-job-submit brokerinfo.jdl  
edg-job-get-output JobId
```

2.12. EXERCISE JS-12: A SIMPLE EXAMPLE OF AN INTERACTIVE JOB

Goal: This exercise will show you how to submit jobs to the grid which require input from the user.

We can specify an interactive job by setting *JobType* on the JDL to “Interactive”. By doing this, our job submission will involve some additional steps: A shadow process will be launched in the background of the console. This process will listen for job standard streams on some port chosen by the OS. A new window is opened where the job streams are forwarded. As this is a X window, we have to make sure that we either connect to the UI via ssh -X or manually set the DISPLAY environment variable to the correct value.

The JDL we will use for this example is the following (*interactive.jdl*):

```
[
  JobType = "Interactive" ;
  Executable = "scriptint.sh" ;
  InputSandbox = {"scriptint.sh"} ;
  OutputSandbox = {"err" , "out" } ;
  StdOutput = "out";
  StdError = "err";
]
```

As the job starts running, a new window will show on the screen with three main areas: Standard Output, Error and Input. In this example we will see the result of *scriptint.sh* on Standard Output. We should provide the necessary input by writing on the window and after the job ends simply close it.

The script executed on the WN is the following one:

```
#!/bin/sh
echo "Welcome !"
sleep 1;
echo "What's your name ?"
read A
echo ``Bye Bye \A``
exit 0
```

The command sequence for this example is this one: `grid-proxy-init`
`edg-job-submit interactive.jdl`
`edg-job-status JobId`

As StdOut and StdError are being redirected to the X window, there are no files coming from these. If we had some additional data being generated on the WN, we could get it as usually using *edg-job-get-output*.

2.13. EXERCISE JS-13: EXECUTION OF PARALLEL JOBS

Goal: The goal of this exercise is to give an example of parallel job submission on the grid.

In DataGrid, parallel job support is currently achieved using the *MPI* library, in this case a portable implementation of *MPI* called *MPICH*.

Currently, execution of parallel jobs is supported only on single CE's but in the future it may be possible to have parallel execution of jobs in different CE's.

From a user point of view, the submission of a parallel job is very similar to the ones we have been trying before ("*single jobs*"). All we need is to give *JobType* the value *MpiCh* and specify the number of nodes we want to use in our job execution.

The JDL for this example is the following one (*parallel.jdl*):

```
[
  JobType = "MpiCh";
  NodeNumber = 4;
  Executable = "cpi";
  InputSandbox = {"cpi"};
  OutputSandbox = {"err", "out"};
  StdOutput = "out";
  StdError = "err";
]
```

Note that an additional Requirement will be added to the JDL specifying that the MPICH software should be installed on all WNs of the selected CE. If none has it currently installed, we will not be able to run this example.

The job consists on the execution of a PI calculation application - *cpi* - which is provided on the exercise's files.

We'll have to issue the following sequence of commands for this example: `grid-proxy-init`

```
edg-job-submit parallel.jdl
```

```
edg-job-status JobId
```

```
edg-job-get-output JobId
```

In the out file retrieved we will have the value for PI as well as other information concerning the job execution.

2.14. EXERCISE JS-14: JOB CHECKPOINTING EXAMPLE

Goal: In this exercise we'll learn how to define and create checkpoints for a job, saving its state and allowing it to be resumed later.

There are two main new features that Job Checkpointing brings to EDG.

At first, it gives the user the ability to save intermediate states for the jobs, allowing them to be resumed in case of a system failure. A job simply restarts from the last saved state, which is an important feature in particular for long-running jobs.

At another level, it gives the ResourceBroker the possibility to stop the execution of a job without necessarily losing what had been done till that point. This is important in several situations: a new job with higher priority just arrived and should be run immediately; during execution it is decided that the job is not suitable for that resource and should be moved elsewhere - in this case, the job will restart in the new resource from the last saved state; etc...

In EDG's checkpointing implementation, a user's application can save its state at any time. This state is defined by the user as a list of `ivar, value;` pairs. Typical cases where this is important and can be easily implemented is inside applications composed by a sequence of steps/iterations. The state of the job could be saved after each one of these steps.

In this example, we're going to submit a job where checkpointing will be performed. The several states of the job will be saved and after its execution, we'll resubmit the job specifying a state from where it should start.

We'll use this JDL (*checkpoint.jdl*):

```
[
JobType = "checkpointable";
Executable = "hsum";
Arguments = " 2000000 200000 gsiftp://lxshare0236.cern.ch/tmp/";
Inputsandbox = {"hsum"};
Outputsandbox = {"err", "out"};
StdOutput = "out";
StdError = "err";
Requirements = member("ROOT", other.GlueHostApplicationSoftwareRunTimeEnvironment);
]
```

Notice the special *JobType*.

`hsum` needs `ROOT` to be installed in the WN, so we'll have to make sure it is available. Also, the arguments passed to the application represent the following: . first argument: 2000000 - the total number of events . second argument: 200000 - the number of events between 2 state saving . third argument: `gsiftp://lxshare0236.cern.ch/tmp/` - the gridftp server directory where the histogram files should be saved

Here is the sequence of actions we should perform:

Submit the job issuing the command: `edg-job-submit checkpoint.jdl`.

Wait for the job to get into *Done (Success)* status. Check it using `edg-job-status jobId`.

After it finishes, we can check that the states were successfully saved. At first, list the directory where we saved the intermediate states: `edg-gridftp-ls -verbose gsiftp://lxshare0236.cern.ch/tmp/`. Some files corresponding to the saved states should be in it. After that, retrieve the output of the job with `edg-job-get-output jobId` and check the contents of the output file. There should be something close to this:

```
CHECKPOINTING at Event = 200000 Waiting 10 seconds... ... ( some more lines here ) ... CHECK-
POINTING at Event = 1800000 Waiting 10 seconds...
```

As we can see, we have the states successfully stored, so although the job was completed, we'll restart it just to show how checkpoint works. The first thing to do is to retrieve an intermediate state of the job. We can do this by issuing `edg-job-get-chkpt -cs 1 -o state-file edg-jobid`. We're simply retrieving the last but one saved state, storing it in the file specified in `state-file`. The `edg-jobid` is the regular job identifier. Check other options available for this command with the `-help` option.

All that's left is to submit the job again, but this time passing it the file with the retrieved state. After the job is finished we can do the normal procedure of returning the output and notice that only the last part of the job was executed. We can also check the gridftp server directory where the files were stored and see how only the file corresponding to the last step in the job was modified.

The complete sequence of commands for this exercise is the following: `grid-proxy-init`

```
edg-job-submit checkpoint.jdl
edg-job-status JobId
edg-job-get-output JobId
edg-job-get-chkpt --cs 1 -o state-file JobId
edg-job-submit -chkpt state-file checkpoint.jdl
edg-job-status JobId
edg-job-get-output JobId
```

The source code for the C++ application is as follows:

```
#include <TCanvas.h>
#include <TH1.h>
#include <TF1.h>
#include <TH2.h>
#include <TProfile.h>
#include <TNTuple.h>
#include <TFile.h>
#include <TROOT.h>
#include <TFrame.h>
#include <TRandom.h>
#include <TSystem.h>
#include <TBenchmark.h>
#include <TApplication.h>
#include <TSlider.h>
#include <unistd.h>
#include <netdb.h>
#include <sys/types.h>
#include <sys/wait.h>
// checkpointing library
#include "edg/workload/checkpointing/client/checkpointing.h"

/*
 * MACRO meaning:
 * WITH_IT => use the iterator
 * WITH_X  => use graphical interface
 * WITH_IMG => take a snapshot of the last chekpointing event
 *          (needs WITH_X set to true)
 */

using namespace edg::workload::checkpointing;

#define BUF_SIZE 1000

TROOT mRoot( "Tracking", "Tracking Root Interface" );
```



```

int main( int argc, char *argv[] ) {

    std::string file;
    bool        first;

    // temporary file
    char *OutFile = "hsum.root";
    std::string OutFileCkpt;
    int  CkptEv, EndEv;
    int  err;
    char *echostr, *hostname, *wd, *tmp;

#ifdef WITH_IT
    int BegEv;
#endif

    if (argc != 4) {
        printf ("Usage: %s <Last_ev> <Ckpt_ev> <SE_path> \n", argv[0]);
        exit(-1);
    } else {
        EndEv = atoi(argv[1]);
        CkptEv = atoi(argv[2]);
        OutFileCkpt = argv[3];
    }

    OutFileCkpt.append("hsum_CHKPT");

    echostr = (char *) malloc(BUF_SIZE);
    tmp = (char *) malloc(BUF_SIZE);
    hostname = (char *) malloc(BUF_SIZE);
    wd = (char *) malloc(BUF_SIZE);
    if ((echostr == NULL) || (tmp == NULL) || (hostname == NULL) || (wd == NULL)) {
        printf("Not enough memory\n");
        exit(-1);
    }

    if ( !getcwd(wd, 255)) wd = "/tmp/";
    gethostname(hostname, 255);

#ifdef WITH_X
    TApplication  tApp( "Buuu", &argc, argv );
#endif

    // Create a new canvas.
    TCanvas *c1 = new TCanvas("c1", "The HSUM example", 200, 10, 600, 400);
    c1->SetFillColor(42);
    c1->GetFrame()->SetFillColor(21);
    c1->GetFrame()->SetBorderSize(6);
    c1->GetFrame()->SetBorderMode(-1);

    TFile    *hsumfile;
    TH1F     *total, *main, *s1, *s2;
    TSlider  *slider = 0;

    try { // initialize a state quering the LB
        JobState state(JobState::job);

```

```

try {
    // take the name of the chkpt_file from the State if it exists
    file = state.getStringValue("hsum_filename")[0];
    printf ("Restarting the Job from the last saved state...\n");
    fflush(NULL);
    // copy the last chkpted file from the SE
    sprintf(echostr, "globus-url-copy %s file://s/%s", file.c_str(), wd, OutFile);
    err = system(echostr);
    if ( WIFSIGNALED(err) || ( WIFEXITED(err) && ( WEXITSTATUS(err) != 0 ) ) ) exit(2);
    hsumfile = new TFile(OutFile, "UPDATE");
    total = (TH1F*)gROOT->FindObject("total");
    main = (TH1F*)gROOT->FindObject("main");
    s1 = (TH1F*)gROOT->FindObject("s1");
    s2 = (TH1F*)gROOT->FindObject("s2");
} catch ( ULEException ) { // the attribute has not been set => first run
    hsumfile = new TFile(OutFile,"RECREATE","Demo ROOT file with sum histogram");
    total = new TH1F("total","This is the total distribution",100,-4,4);
    main = new TH1F("main","Main contributor",100,-4,4);
    s1 = new TH1F("s1","This is the first signal",100,-4,4);
    s2 = new TH1F("s2","This is the second signal",100,-4,4);
    total->Sumw2(); // this makes sure that the sum of squares of weights will be stored
    total->SetMarkerStyle(21);
    total->SetMarkerSize(0.7);
    main->SetFillColor(16);
    s1->SetFillColor(36);
    s2->SetFillColor(46);
}
#endif

#ifdef WITH_IT
try {
    // take the number of the first event from the State if it exists
    BegEv = state.getIntValue("first_event")[0];
    printf ("Start from event %d\n", BegEv);
    fflush(NULL);
} catch ( ULEException ) { // the attribute has not been set
    BegEv = 0;
}
#endif

try {
    // take the boolean variable to decide which distribution must be plotted
    first = state.getBoolValue("distribution")[0];
} catch ( ULEException ) { // the attribute has not been set
    first = true;
}

// Fill histograms randomly
gRandom->SetSeed();
Int_t i;
const Int_t kUPDATE = 500;
Float_t xs1, xs2, xmain;

#ifdef WITH_IT
try {
// Step st = state.getCurrentStep();
while ( Step st = state.getCurrentStep() ) {
    i = st.getInteger();

```

```

        st = state.getNextStep();
#else
    for ( i=BegEv; i < EndEv; i++ ) {
#endif
    if ( first ) {
        xmain = gRandom->Gaus(-1,1.5);
        xs1   = gRandom->Gaus(-0.5,0.5);
        xs2   = gRandom->Landau(1,0.15);
    } else {
        xmain = gRandom->Gaus(3,0.75);
        xs1   = gRandom->Gaus(-1.75,0.25);
        xs2   = gRandom->Landau(-3,0.20);
    }

    main->Fill(xmain);
    s1->Fill(xs1,0.3);
    s2->Fill(xs2,0.2);
    total->Fill(xmain);
    total->Fill(xs1,0.3);
    total->Fill(xs2,0.2);
    if ( i && (i%kUPDATE) == 0 ) {
        if ( i == kUPDATE ) {
            total->Draw("elp");
            main->Draw("same");
            s1->Draw("same");
            s2->Draw("same");
            c1->Update();
            slider = new TSlider("slider","test",4.2,0,4.6,total->GetMaximum(),38);
            slider->SetFillColor(46);
        }
        if (slider) slider->SetRange(0,Float_t(i)/10000.);
        c1->Modified();
        c1->Update();
        if (gSystem->ProcessEvents())
            break;
    }

    // checkpointing...
    if ( i && (i%kCkptEv) == 0 ) {
        if ( ((i/CkptEv)%2) == 0 ) first = !first; // change the distribution definitions
#ifdef WITH_IMG
        c1->SaveAs("sumshot.gif");
#endif
        printf ("CHECKPOINTING at Event = %d\n", i);
        fflush(NULL);
        hsumfile->Write();

#ifdef WITH_IT
        // store the BegEv
        state.saveValue("first_event", i+1); // the next first event should be i+1, right?
#endif
        // copy the OutFile to the SE
        sprintf(tmp, "%s_%s_%d.root", OutFileCkpt.c_str(), gethostbyname(hostname)->h_name, i);
        sprintf(echostr, "globus-url-copy file://%s/%s %s", wd, OutFile, tmp);
        err = system(echostr);
        if ( WIFSIGNALED(err) || ( WIFEXITED(err) && ( WEXITSTATUS(err) != 0 ) ) ) exit(2);
        // store the name of the file in the State object

```

```
state.saveValue("hsum_filename", (std::string)tmp);
state.saveValue("distribution", first);

try {
    err = state.saveState();
    if ( err ) {
        printf ("Save State failed!!! Error: %d \n", err);
        // exit(1); // don't exit if a save failed
    }
} catch ( ChkptException &exc ) {
    printf ("CHECKPOINTING failed!!! Exception message: %s\n", exc.dbgMessage().c_str());
    //exit(1); // don't exit if a save failed
}
printf( "%s\n", "Waiting 10 seconds..." );
sleep(10);
}
} // close while or for
#ifdef WITH_IT
} catch (EoSException) {}
#endif

//Save all objects in this file
total->Draw("sameaxis"); // to redraw axis hidden by the fill area
c1->Modified();

} catch (ChkptException &exc) { // failed to retrieve the first state --> abort
printf ("CHECKPOINTING failed!!! Exception message: %s\n", exc.dbgMessage().c_str());
exit(1);
}

// Note that the file is automatically close when application terminates
// or when the file destructor is called.

free(hostname);
free(tmp);
free(echostr);
free(wd);

exit(0);

#ifdef WITH_X
tApp.Run( kTRUE );
#endif
}
```

3. DATA MANAGEMENT EXERCISES

In the exercises JS-1 to JS-11 we have seen how to submit jobs, query the job's status, retrieve the output and packaging everything needed by our job into the Input and Output sandboxes. However, one does not use Input and Output Sandboxes for Data Management on the Grid.

On the contrary, the idea of using sandboxes is more thought as for providing small auxiliary files to the jobs, like data cards for the various Monte Carlo events generating programs, or small required libraries for the executables.

We still have to discover and understand how to handle large files, distributed all over the Grid, how to make other users aware of the availability of files owned by us on our Storage Elements and how to be able to find out where to find useful replicas for us to be used in our jobs.

For this purpose there is a set of tools that allows users to replicate files from one Storage Element to another, to register files with a Replica Catalog, etc. The main tool for this purpose is the **EDG Replica Manager** that uses a set of services (**Replica Location Service**, **Replica Metadata Catalog**, **Replica Optimization Service** etc. In this set of exercises you will learn how to use the replica manager as well as the associated services. In more details, the EDG Replica Manager has a complete set of tools to create replicas of files between Storage Elements, Computing Elements (Worker Nodes) etc. and register files in the Replica Catalogs.

For the exercises we assume that you use the following **User Guides** for the relevant tools and services:

- EDG Replica Manager, Replica Location Service, Replica Metadata Catalog:

<http://cern.ch/edg-wp2/replication/documentation.html>

- Replica Optimization Service

<http://cern.ch/edg-wp2/optimization/documentation.html>

For more background on the overall set of data management services provided by EDG, refer to the web following web sites:

<http://cern.ch/edg-wp2/publications.html>

<http://web01.esc.rl.ac.uk/projects/DataGrid/wp5/documentation.html>

In following examples you will use several files names (Logical File Name, SURL, etc.) which require a specific syntax. For more information, please refer to the Glossary in Section 6.1..

NOTE

Filenames used in these examples are to be taken as example names.

When registering files into Replica Catalogs, LFNs must be **unique**, moreover, you are all sharing the same directories. Therefore, try to use fancy and imagination to use your own filenames in order to avoid conflicts. A good way could be using filenames containing your complete name.

3.1. EXERCISE DM-1: DISCOVER GRID STORAGE

Goal: The goal of this exercise is to find out where Grid Storage is available and how it can be accessed. With the use of simple tools you will learn how to discover storage space in the Grid, mainly using the following command:

- `edg-rm printInfo`

In general, all Storage Elements registered with the Grid publish, through the Grid Information System, the location of the directory where to store files. This directory on the SE is usually VO dependent (each defined VO has its own one) but the location can also be hidden by the underlying Storage Element or **Storage Resource Manager**. In EDG, a Storage Element is mainly implemented by a Storage Resource Manager and thus both terms are used in the remainder of this document.

There are several ways to retrieve information about Storage Elements and their attributes. One way is to directly query the Information System and you will learn how to do so in the exercises about Information Systems (see Section 4.). In addition, the EDG Replica Manager provides a method called `printInfo` to query the most basic information of a Storage Element. Here we give details on how to do that.

Issue the following **EDG Replica Manager** command:

```
> edg-rm --vo=tutor printInfo
```

Note that we assume that you use the VO tutor. A possible (reduced) output looks as follows:

```
VO used           : tutor
default SE        : pcrd24.cern.ch
default CE        : lxshare0313.cern.ch
Info Service class : org.edg.data.reptor.info.InfoServiceStub

RMC endpoint      : http://adc0013.cern.ch:8080/edg-replica-metadata-
catalog/services/edg-replica-metadata-catalog
LRC endpoint      : http://adc0013.cern.ch:8080/edg-replica-location/
services/edg-local-replica-catalog
ROS endpoint      :
http://lxshare0343.cern.ch:8080/edg-replica-optimization/services/
edg-replica-optimization

List of CE ID's   : gppce06.gridpp.rl.ac.uk:2119/jobmanager-pbs-S
                  gppce06.gridpp.rl.ac.uk:2119/jobmanager-pbs-M
                  gppce06.gridpp.rl.ac.uk:2119/jobmanager-pbs-L
[...]

List of SE ID's   : gppse02.gridpp.rl.ac.uk
                  lxshare0408.cern.ch
                  tbn07.nikhef.nl

SE at RAL :
              name : RAL
              host : gppse06.gridpp.rl.ac.uk
              type : disk
              accesspoint : /flatfiles/SE01
              VOs : lhcb,cms,tutor
VO directories : lhcb:/lhcb,cms:/cms,tutor:/tutor
              protocols : file,rfio,gsiftp
```

[...]

SE at CERN-DEV :

```

    name : CERN-DEV
        host : lxshare0408.cern.ch
        type : edg-se
    accesspoint : /flatfiles/SE00
        endpoint : http://lxshare0408.cern.ch:8080/edg-se-webservice/services/edg-se-we
            VOs : lhcb,cms,tutor
    VO directories : lhcb:/lhcb,cms:/cms,tutor:/tutor
        protocols : gsiftp,file,rftio
    
```

The output presents information about all possible Computing Elements (CEs) as well as Storage Elements that are registered with the information service. We are mainly interested in the Storage Elements and their storage locations. The number of SEs given shows you how many SEs you can possibly use. Note that you also need to find an SE that allows for your VO (tutor). As a first exercise, go through the output and discover how many SEs you can use.

The SE can be implemented in several ways which has an impact on the directory where files are stored:

1. The SE is a conventional disk server with a GridFTP interface. That is a simple solution that does not require additional SE software but has several disadvantages as regards space management on the disk.
2. On the Storage Element, a particular SRM (or EDG-SE) is running that takes care of space management, interfacing to Mass Storage Systems etc.

In case of a conventional disk server that runs GridFTP (`type : disk`, this path might be exposed. In case the SE is running an SRM or EDG-SE (`type : edg-se`), the path might not be there since the SRM decides internally where files can be written to.

In all cases, the VO specific directories can be obtained by combining the following two attributes `accesspoint` and `VO Directories`. For example:

```

        host : lxshare0408.cern.ch
    accesspoint : /flatfiles/SE00
    VO directories : lhcb:/lhcb,cms:/cms,tutor:/tutor
    
```

Thus, files for the VO tutor are written into the directory `/flatfiles/SE00/tutor`.

ADVANCED AND RELATED EXERCISE

One way to query all possible Storage Elements is to use the Information System (i.e. R-GMA) directly. You will find details in Section 4. but you can already look ahead and try R-GMA queries like the following:

```
rgma> latest select GlueSEUniqueID from GlueSL;
```

where you select all the unique IDs (i.e. names of Storage Elements). GlueSL stands for “Glue Storage Library” and corresponds to the SE as indicated in the output of `printInfo`.

3.2. EXERCISE DM-2: START USING THE EDG REPLICA MANGER

Goal: In this example we will use the EDG Replica Manager for copying files from the UI to a known Grid storage (SE). Next we will list the directory information to check whether the copy operation was successful.

Note: During this exercise the Replica Catalogue will not be updated since we only perform a copy rather than a replication operation. File replication will be part of the next exercise.

We will use the following commands:

- `printInfo`
- `copyFile`
- `list`

In this example we issue a `grid-proxy-init` to get a valid proxy and then we will transfer a file from the User Interface to one Storage Element just to start learning how to move files around the Grid (see Figure 10).

Note that the machine names and the directories change over time: please consult your tutorial web page for the exact machine names or inquire the machine information as shown in exercise DM-1! All machine names given here are only examples but they are not necessarily the one you can use.

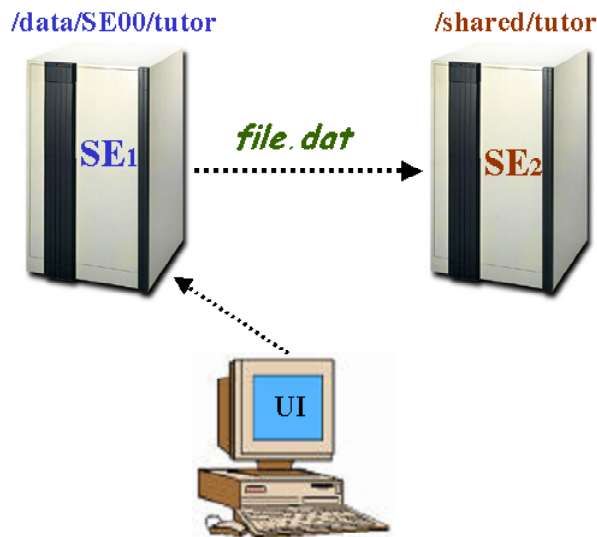

Figure 10: Basic file copy operation between two Storage Elements

We first create a simple file in the current directory on the UI and next copy it with the EDG Replica Manager to an SE. For all examples we assume that we are part of the VO “tutor”³.

Create a file:

```
echo "file.dat" > file.dat
```

Copy the file to a known SE. We can get a list of known SEs with the command `printInfo`:

³In case you are *not* running these exercises in an EDG tutorial *and* you part of a different VO (e.g. wpsix, cms, etc.) please use your personal VO instead.

```
edg-rm --vo=tutor printInfo
```

Typical SEs are:

```
List of SE ID's      : pcrd24.cern.ch
                    : ccgridli02.in2p3.fr
                    : gppse06.gridpp.rl.ac.uk
                    : se01.nikhef.nl
                    : testbed007.cnaf.infn.it
```

Each SE might have a default directory for the files of a particular VO. For instance, on the SE `pcrd24.cern.ch` the default directory for VO “tutor” is:

```
SE at CERN :
            name : CERN
            host : pcrd24.cern.ch
            type : disk
VO Directory : tutor : /data/temp
            protocols : gsiftp
```

We now want to copy the file `file.dat` from the current directory to the directory `/data/temp` on the SE `pcrd24.cern.ch`

```
edg-rm --vo=tutor copyFile file://`pwd`/file.dat \
gsiftp://pcrd24.cern.ch/data/temp/file.dat
```

Note that since the source file is available on the local file system, the prefix `file:` has been used to refer to a local file.

We can check whether the copy operation was successful with the command `list`

```
edg-rm --vo=tutor list gsiftp://pcrd24.cern.ch/data/temp/file.dat
```

As an additional exercise, try to copy a file from the current SE that you have chosen to an additional SE, as depicted in Figure 10.

3.3. EXERCISE DM-3: FILE REPLICATION WITH THE EDG REPLICA MANGER

Goal: In this example we will use the EDG Replica Manager for replicating files between various SEs and get familiar with the basic catalogue commands to list and delete replicas.

We will use the following commands:

- copyAndRegisterFile
- replicateFile
- listReplicas
- deleteFile
- listGUID

We first create a file in the current directory that we want to replicate afterwards.

```
echo ``file.kurt`` > file.kurt
```

We now want to copy the file to an SE and register it in the replica catalogue with the logical file name (LFN) lfn:file.kurt. Note that an LFN needs to start with the prefix lfn:. We also provide a specific name and directory for the file on the destination SE.

```
edg-rm --vo=tutor copyAndRegisterFile file://`pwd`/file.kurt \  
-l lfn:file.kurt \  
-d srm://pcrd24.cern.ch/data/temp/file.kurt1
```

On successfully copying, a GUID is returned which uniquely identifies the replicas of file.kurt (with the LFN lfn:file.kurt):

```
guid:ec3ee4d2-a653-11d7-849e-ea0706438314
```

We can check the replicas of a specific LFN that are registered in the replica catalogue with listReplicas.

```
edg-rm --vo=tutor listReplicas lfn:file.kurt
```

As the result we get:

```
srm://pcrd24.cern.ch/data/temp/file.kurt1
```

Now we replicate the file from CERN to an SE at France. We only specify the destination host and let the Replica Manager create the file name and place the file into the correct directory.

```
edg-rm --vo=tutor replicateFile srm://pcrd24.cern.ch/data/temp/file.kurt1 \  
-d ccgridli07.in2p3.fr
```

The generated file name and thus the second replica looks, for instance, like follows:

```
srm://ccgridli07.in2p3.fr//tmp/generated/2003/06/24/file7572af6a-a655-11d7-8b9d-db2322879f7d
```

When we now list the replicas of our specific LFN lfn:file.kurt

```
edg-rm --vo=tutor listReplicas lfn:file.kurt
```

we should get two replicas at different locations:

```
srm://ccgridli07.in2p3.fr/tmp/generated/2003/06/24/file7572af6a-a655-11d7-8b9d-db2322879f7d
srm://pcrd24.cern.ch/data/temp/file.kurt1
```

We finally want to create a third replica in Scotland. As a source we specify the LFN and let the Replica Manager find the best copy which is then replicated.

```
edg-rm --vo=tutor replicateFile lfn:file.kurt -d grid01.ph.gla.ac.uk
```

Assume that we need all the storage space at CERN for some other application and so we want to delete the replica at the CERN SE.

```
edg-rm --vo=tutor deleteFile srm://pcrd24.cern.ch/data/temp/file.kurt1
```

Now assume that none of the replicas is needed any more and we want to delete all of them. In case we have forgotten the GUID of the replicas associated with a specific LFN, we can retrieve it with:

```
edg-rm --vo=tutor listGUID lfn:file.kurt
```

We can now delete all the files by specifying the GUID we have just retrieved. Note that with the option `-a` we delete all replicas of a specific GUID.

```
edg-rm --vo=tutor deleteFile guid:ec3ee4d2-a653-11d7-849e-ea0706438314 -a
```

When we now list the replicas of LFN `file.kurt`

```
edg-rm --vo=tutor listReplicas lfn:file.kurt
```

we should get the following result:

```
java.io.FileNotFoundException: File not in catalog : lfn:file.kurt
```

since there is no replica anymore of that LFN.

3.3.1. ADVANCED EXERCISE - USING A STATIC CONFIGURATION FILE FOR INFORMATION SERVICE

Note that the following exercises is for advanced users only.

Goal: In the following exercise you are asked to use the EDG Replica Manager with a static configuration file for the Information Service and then remove/add an SE that only has a disk and does not provide an SRM interface. This is a very useful exercise in case the Information Service is not on-line and you still need to run the EDG Replica Manager commands. In addition, it is also useful if you need to quickly add new machines (SEs) and test them: this it is very helpful for **debugging**.

For this exercise you need to consult the EDG Replica Manager **Installation Guide** which can be obtained from the same link where you also find the **User Guide**.

Here, we only give you a few hints and you would need to find out the details yourself:

1. You need to change the configuration file `edg-replica-manager.conf` and point to it when you use an EDG Replica Manager command.
2. In the configuration file `edg-replica-manager.conf` you can set the information service that you want to use. You want to configure the replica manager in a way that it does not contact an information service but it uses a local configuration file from which it obtains all SE and CE information etc.
3. You need to create a file called `info-service-stub.properties` and copy it to your home directory unless your machine is not already configured in a way that it uses a configuration file. For more hints on what this file has to look like, please refer to the Appendix of the Installation Guide or to the following web page:

`http://datagrid.in2p3.fr/cvsweb/edg-reptor/config/info-service-stub.properties`

4. Make sure you point your configuration to the file above (hint: check in the file `edg-replica-manager.conf`).

Once you have achieved all this, you can try to experiment with the file `info-service-stub.properties` and remove/add a new Storage Element or Computing Element.

Note that the information you see in the `info-service-stub.properties` is very similar to the one provided by the command `printInfo`. Please check Exercises DM1 for synergies.

3.4. EXERCISE DM-4: USING THE REPLICA CATALOG

Goal: After some preliminary replica catalogue interaction in the previous exercise, we now go a bit more into detail with using the replica catalogue with the EDG Replica Manager and use the following commands:

- `addAlias, removeAlias`
- `registerFile, unregisterFile`

As described in detail in the EDG Replica Manager User Guide⁴, the replica catalogue components consists of two parts:

1. **Replica Location Service (RLS):** you will get more information in Exercise DM-6
2. **Replica Metadata Catalog (RMC):** you will get more information in Exercise DM-7

Although as a user you would not need to know all the details for simple replication commands, but for more complex queries and inserts you would need to distinguish that the two services store different information as depicted in Figure 11.

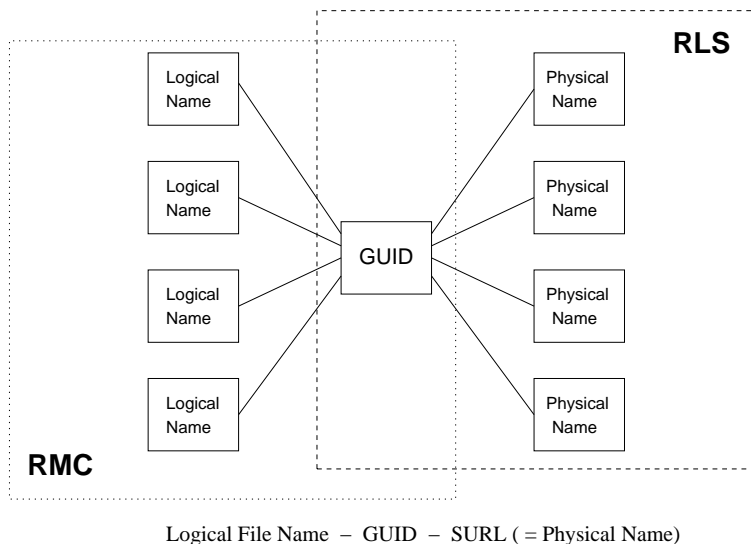

Figure 11: The Logical File Name to GUID mapping is maintained in the Replica Metadata Catalog, the GUID to Physical File Name (SURL) mapping in the RLS.

In the previous example, the commands `listReplicas` and `listGUID` were used in order to retrieve certain SURLs⁵ for details on file naming conventions or GUIDs based on a given filename. These commands use both catalogues transparently. We first show how additional commands can be used and then point out the limitations of the replica manager interface and refer to the specific interfaces for the RLS and RMC respectively.

For files that are already stored on a Storage Element but not yet registered with a Replica Catalogue, we can use the command `registerFile` as follows:

```
edg-rm --vo=tutor registerFile \  
srm://pcrd24.cern.ch/data/temp/my-name-second-name
```

⁴<http://cern.ch/edg-wp2/replication/documentation.html>

⁵refer to Section 6.1.

Note that the file might not be there yet. Please transfer the file there and then issue the command above depending on your name. The command then returns a GUID, e.g. `guid:85c71452-a714-11d7-89d1-fd96669a052b`.

A GUID that is registered with the Replica Location Service can have several LFNs (also referred to as Aliases). We now show how you can add and remove several aliases for a given GUID. For example add, two alias names to the given GUID:

```
edg-rm --vo=tutor addAlias guid:85c71452-a714-11d7-89d1-fd96669a052b \  
lfn:my-first-lfn
```

```
edg-rm --vo=tutor addAlias guid:85c71452-a714-11d7-89d1-fd96669a052b \  
lfn:my-second-lfn
```

Then, we can remove one of the alias names:

```
edg-rm --vo=tutor removeAlias guid:85c71452-a714-11d7-89d1-fd96669a052b \  
lfn:my-second-lfn
```

In case you do not want to have the file registered anymore in the Replica Catalogue but you do not want to delete the file, you can use the command `unregisterFile`:

```
edg-rm --vo=tutor unregisterFile guid:85c71452-a714-11d7-89d1-fd96669a052b \  
srm://pcrd24.cern.ch/data/temp/my-name-second-name
```

As an additional exercise, please try different combinations of the commands to get an idea about the LFN/alias usage.

Note: As you might have already realised, the interface to the replica catalogue (provided by the EDG Replica Manager) does not give you a full set of query functions like wild card queries SURLS, GUIDs, LFNs etc. In order to do so, you would need to use the direct interfaces to the RLS and RMC as we will see in the the exercises DM-6 and DM-7.

3.5. EXERCISE DM-5: REPLICA OPTIMISATION WITH THE EDG REPLICA MANAGER

Goal: In this example we will use the EDG Replica Manager basic file replication and optimisation.

We will use the following commands:

- `copyAndRegisterFile`
- `replicateFile`
- `listReplicas`
- `listGUID`
- `listBestFile`
- `getBestFile`
- `getAccessCost`
- `deleteFile`

In the scenario the user knows that there is a file available at CERN, that has been put on a host accessible through GridFTP. It is not a grid-aware store, so first the user has to copy the file to a Storage Element and register it in the Grid. Say that for some reason the user cannot copy it to the local CERN Storage Element but has to copy it to the one at IN2P3 in France.

In the example the file is called `higgs0` and resides at `testbed008.cern.ch/tmp/`.

Copy and registration is an atomic operation. In the example we assign also a Logical File Name alias to it in the process, `lfn:higgs`, which is easier to remember than the GUID that is returned by the call:

```
edg-rm --vo=tutor copyAndRegisterFile gsiftp://testbed008.cern.ch/tmp/higgs0 \  
-l lfn:higgs -d srm://ccgridli02.in2p3.fr/edg/StorageElement/dev2/tutor/higgs
```

A GUID is created and returned to the screen:

```
guid:7c29f32b-4964-11d7-a86c-9ee9a33b1f19
```

To verify whether the operation got successfully executed, we can issue `listReplicas`:

```
edg-rm --vo=tutor listReplicas lfn:higgs
```

which yields:

```
srm://ccgridli02.in2p3.fr/edg/StorageElement/dev2/tutor/higgs
```

In order to retrieve the GUID based on the LFN, we can issue

```
> edg-rm --vo=tutor listGUID lfn:higgs
```

As a second step, the user might want to have a replica of this data file available at NIKHEF in the Netherlands, because he intends to share it or to submit jobs that require resources at NIKHEF. A replica can be created using the `replicateFile` command:

```
edg-rm --vo=tutor replicateFile lfn:higgs \  
-d srm://se01.nikhef.nl/flatfiles/tutor/higgs
```

The command confirms its execution by returning the actual SURL used. If the `-d` option is omitted, an automatic SURL would have been created. Here the output is:

```
srm://se01.nikhef.nl/flatfiles/tutor/higgs
```

To list all replicas now in the system, we can issue `listReplicas` again:

```
edg-rm --vo=tutor listReplicas lfn:higgs
```

which yields:

```
srm://ccgridli02.in2p3.fr/edg/StorageElement/dev2/tutor/higgs
```

```
srm://se01.nikhef.nl/flatfiles/tutor/higgs
```

To see which replica has the best network connection to CERN, we can use `listBestFile`:

```
edg-rm --vo=tutor listBestFile lfn:higgs -d pcrd24.cern.ch
```

The output is, for example:

```
srm://se01.nikhef.nl/flatfiles/tutor/higgs
```

which means that the file at NIKHEF can be made available at CERN faster than the one from LYON.

We now want to see the file access costs of the best replica with respect to CERN, NIKHEF and Lyon.

```
edg-rm --vo=tutor getAccessCost -l lfn:higgs \
-d lxshare0313.cern.ch ce01.nikhef.nl ccgridli01.in2p3.fr
```

The output is:

```
Access Cost 0 :
CE = lxshare0313.cern.ch
0:srm://se01.nikhef.nl/flatfiles/tutor/higgs
TotalTime = 0.13
```

```
Access Cost 1 :
CE = ce01.nikhef.nl
0:srm://se01.nikhef.nl/flatfiles/tutor/higgs
TotalTime = 0.0
```

```
Access Cost 2 :
CE = ccgridli01.in2p3.fr
0:srm://ccgridli02.in2p3.fr/edg/StorageElement/dev2/tutor/higgs
TotalTime = 0.0
```

The list is grouped by the CEs given on the command line. For each CE the 'best' replica is listed and the time it would take to make it available locally. We can see that the expected access cost to CERN is 0.13 sec for the replica from NIKHEF, which is better than the one at Lyon (so that one is not listed at all). For the other sites the access cost is 0 since the file is already locally available and no network transfer is required.

To actually make the best file available at CERN, we can issue `getBestFile`

```
edg-rm --vo=tutor getBestFile lfn:higgs -d pcrd24.cern.ch
```

The output is something like:

```
srm://pcrd24.cern.ch/data/temp/a6289c7c-4966-11d7-bc63-d91230733e2d
```

We should now have three replicas:

```
edg-rm --vo=tutor listReplicas lfn:higgs
```

The output is:

```
srm://pcrd24.cern.ch/data/temp/aaa64014-4967-11d7-a6cc-f7a1ff1899b0  
srm://se01.nikhef.nl/flatfiles/tutor/higgs  
srm://ccgridli02.in2p3.fr/edg/StorageElement/dev2/tutor/higgs
```

To delete a replica we can use the deleteFile command:

```
edg-rm deleteFile lfn:higgs -s ccgridli02.in2p3.fr
```

As an exercise, please try to create a few more replicas, see how the commands listBestFile and getBestFile work on your replicas.

3.6. EXERCISE DM-6: USING THE REPLICA LOCATION SERVICE

Goal: In this example we will use the Replica Location Service for performing basic replica catalogue operations.

Note: This exercise is considered for administrators only since the operations do not do any consistency checks. For instance, one can create a GUID-PFN mapping even though the PFN does not exist. End users are asked to use the Replica Manager commands for these operations.

We will use the following commands:

- ping (administration command)
- mappingsByGuid
- mappingsByPfn
- guidExists
- addMapping
- listAttrDefns
- addAttrDefn
- removeAttrDefn
- setPfnAttr
- getPfnAttr
- removePfnAttr
- removePfn

The first step is to check whether the RLS server is up and running. This can be done with a simple ping command (see below). The hostname of the RLS server can be obtained via the EDG Replica Manager command `printInfo` where the entire LRC endpoint (URL) of the service is given as shown in exercise DM1. You only need to take the host name of the URL.

```
edg-lrc-admin -i ping -h adc0013.cern.ch
```

If the server is up, the number of registered GUIDs and PFNs⁶ is returned:

```
OK : 553 GUIDs, 573 Pfns.
```

All the GUID-PFN mappings can be retrieved with:

```
edg-lrc -i mappingsByGuid "*" -h adc0013.cern.ch
```

A typical result is:

```
guid:00c8b0cd-a730-11d7-801a-e343a9ee0c1f, srm://tbn03.nikhef.nl/flatfiles/  
tutor/cmkin.out.030425120250  
guid:00ccc27e-a720-11d7-9296-a4690dc71cde, srm://se010.fzk.de//flatfiles/  
tutor/h4mu_130_1.kinlis.030423101731  
guid:0277dacf-a7b4-11d7-8839-b121e819388b, srm://grid001.to.infn.it//flatfiles/  
SE00/tutor/filelist.lfn.030423104108
```

⁶Note that the term PFN is used here but it is equivalent to the SURL of previous exercises

In case you get a security error, you can also try to use the option `-i` in order to connect to the server in an insecure mode:

```
edg-lrc -i mappingsByGuid "*" -h adc0013.cern.ch
```

The PFN-mappings can be queried in a similar way:

```
edg-lrc -i mappingsByPfn "*" -h adc0013.cern.ch
```

For instance, all the PFNs stored at NIKHEF, can be retrieved as follows:

```
edg-lrc -i mappingsByPfn "*nikhef*" -h adc0013.cern.ch
```

Result:

```
guid:00c8b0cd-a730-11d7-801a-e343a9ee0c1f, srm://tbn03.nikhef.nl/flatfiles/
tutor/cmkin.out.030425120250
guid:036be6ce-a7ae-11d7-92ad-95e140d2ab86, srm://tbn03.nikhef.nl/flatfiles/
tutor/h4mu_130_1.ntpl.030506101324
guid:0401d348-a7b0-11d7-b37b-e2d53058f5eb, srm://tbn03.nikhef.nl/flatfiles/
tutor/ff_cards.cmkin.030425120123
guid:0c47f094-a7b1-11d7-95cc-ba61336cf560, srm://tbn03.nikhef.nl/flatfiles/
tutor/start_cmkin.sh.030425120016
...
```

Next we create a new GUID-PFN mapping. In order to make sure that our GUID `guid:myGuid1` is unique, we will first check whether it exists in the catalogue.

```
edg-lrc -i guidExists guid:myGuid1 -h adc0013.cern.ch
```

Result:

```
GUID does not exist : 'guid:myGuid1'
```

```
edg-lrc -i addMapping guid:myGuid1 pfn:myPfn1 -h adc0013.cern.ch
```

We can now check whether the mapping was successfully entered:

```
edg-lrc -i mappingsByGuid "guid:myGuid1" -h adc0013.cern.ch
```

Result:

```
guid:myGuid1, pfn:myPfn1
```

Next we want to add the attribute `size` to the PFN `pfn:myPfn1`. Let us first check which attribute definitions are entered in the catalogue:

```
edg-lrc -i listAttrDefns -h adc0013.cern.ch
```

Result:

```
size , string
owner , string
```

Since the attribute size is already registered, we can set the size of PFN pfn:myPfn1 to say 1000:

```
> edg-lrc -i setPfnAttr pfn:myPfn1 size 1000 -h adc0013.cern.ch
```

We can now check whether the operation was successful.

```
edg-lrc -i getPfnAttr pfn:myPfn1 size -h adc0013.cern.ch
```

Now we want to add a new attribute called description to the catalogue.

```
edg-lrc -i addAttrDefn description string -h adc0013.cern.ch
```

This new attribute will be set for our PFN pfn:myPfn1.

```
edg-lrc -i setPfnAttr pfn:myPfn1 description "This PFN contains CMS higgs \
candidates" -h adc0013.cern.ch
```

Let us assume, we do not need the file size attribute of pfn:myPfn1 any more and we wish to delete it:

```
edg-lrc -i removePfnAttr pfn:myPfn1 size -h adc0013.cern.ch
```

Now assume that we also do not need to attribute description any more in the whole catalogue:

```
edg-lrc -i removeAttrDefn description -h adc0013.cern.ch
```

Finally, we want to remove the GUID-PFN mapping for pfn:myPfn1

```
edg-lrc -i removePfn guid:myGuid1 pfn:myPfn1 -h adc0013.cern.ch
```

ADVANCED EXERCISE

Create your own GUID-PFN mappings with different attributes and clean up the catalogue afterwards.

3.7. EXERCISE DM-7: USING THE REPLICA METADATA CATALOG

Goal: In this example we will use the Replica Metadata Catalog for performing basic replica metadata catalogue operations.

Note: This exercise is considered for administrators only since the operations do not do any consistency checks. For instance, one can create a GUID-alias mapping even though the alias does not exist. End users are asked to use the Replica Manager commands for these operations.

We will use the following commands:

- ping (administration command)
- mappingsByGuid
- mappingsByAlias
- guidExists
- addAlias
- listGuidAttrDefns
- listAliasAttrDefns
- addGuidAttrDefn
- setGuidAttr
- getGuidAttr
- removeGuidAttr
- removeGuidAttrDefn

Before we start using the Replica Metadata Catalog, we check whether it is up and running (see below). The hostname of the RMC server can be obtained via the EDG Replica Manager command `printInfo` where the entire RMC endpoint (URL) of the service is given as shown in exercise DM1.

```
edg-rmc-admin -i ping -h adc0013.cern.ch
```

As a result we get back the number of GUIDs and aliases that are stored in the catalogue.

```
OK : 825 GUIDs, 794 Aliases.
```

All the GUIDs and aliases can be retrieved with:

```
edg-rmc -i mappingsByGuid "*" -h adc0013.cern.ch
```

Result:

```
guid:00c8b0cd-a730-11d7-801a-e343a9ee0c1f, lfn:cmkin.out.030425120250
guid:00ccc27e-a720-11d7-9296-a4690dc71cde, lfn:h4mu_130_1.kinlis.030423101731
guid:017a3910-a7c2-11d7-b237-fbaf79cbba14, lfn:h4mu_130.ntpl.030423102714
```

Similarly, the mappings by alias can be queried with:

```
edg-rmc -i mappingsByAlias "*" -h adc0013.cern.ch
```

Next we want to add a new GUID-alias mapping. Before doing so, we make sure that the GUID `guid:myGuid1` is unique and thus does not exist in the catalogue:

```
edg-rcm -i guidExists guid:myGuid7 -h adc0013.cern.ch
```

Result:

```
GUID does not exist : 'guid:myGuid7'
```

We can now add the mapping:

```
edg-rcm -i addAlias guid:myGuid7 alias:alias7 -h adc0013.cern.ch
```

We now check whether the mapping was successfully entered:

```
edg-rcm -i mappingsByGuid "guid:myGuid7" -h adc0013.cern.ch
```

Result:

```
guid:myGuid7, alias:alias7
```

Next, we want to add a new attribute definition. The respective attributes can be checked with:

```
edg-rcm -i listGuidAttrDefns -h adc0013.cern.ch
```

```
edg-rcm -i listAliasAttrDefns -h adc0013.cern.ch
```

Assume we want to add the attribute `owner` for the GUID `guid:myGuid7` and enter a specific value.

```
edg-rcm -i addGuidAttrDefn owner string -h adc0013.cern.ch
```

```
edg-rcm -i setGuidAttr guid:myGuid7 owner "kurt" -h adc0013.cern.ch
```

We can check the whether the entry was entered successfully:

```
edg-rcm -i getGuidAttr guid:myGuid7 owner -h adc0013.cern.ch
```

Result:

```
kurt
```

Next we want to remove the GUID attribute again:

```
edg-rcm -i removeGuidAttr guid:myGuid7 owner -h adc0013.cern.ch
```

Finally, we want to remove the GUID attribute definition from the whole catalogue:

```
edg-rcm -i removeGuidAttrDefn owner -h adc0013.cern.ch
```

ADVANCED EXERCISE

Create your own GUID-alias mappings with different attributes and clean up the catalogue afterwards.

3.8. EXERCISE DM-8: USING THE EDG REPLICA MANAGER WITHIN A JOB

Goal: In this exercise we are going to use the EDG Replica Manager inside a Job. We will copy a file from the Worker Node, where it is created, to a Storage Element, and register the file with a Replica Catalog. The file is a postscript file created by PAW on the worker node (see also exercise JS-3).

Contrary to the previous examples on Data Management, this time we need to write a JDL file with the description of the job we want to submit to the system: we create a JDL file which runs PAW on a Worker Node of a given Computing Element, copies and registers this file using the command:

```
edg-rm --vo=tutor copyAndRegisterFile
```

and we finally check that the produced file is correctly registered inside the Replica Catalog. The JDL we are going to use is the following one:

```
Executable = "/bin/sh";
Arguments = "edgRM.sh testgrid.ps";
InputSandbox = {"edgRM.sh", "pawlogon.kumac", "testgridnew.kumac", "paw.metafile"};
OutputSandbox = {"stderr.log", "StdOutput.log", "testgrid.ps"};
Stderror = "stderr.log";
StdOutput = "StdOutput.log";
Requirement = Member("CMS-1.1.0", other.GlueHostApplicationSoftwareRunTimeEnvironment);
```

The issued commands sequence we have to use is the following one :

```
> grid-proxy-init
>
> edg-job-submit --resource testbed001.cnaf.infn.it:2119/ \
> jobmanager-pbs-medium edgRM.jdl
>
> edg-job-status JobId
>
> edg-job-get-output JobId
```

Have a look at the file `edgRM.sh` where the commands executed on the *WorkerNode* are specified. We first run the PAW application and after that we register and copy the result file. The reference to an environment variable - `CMS_ROOT_DIR` - is just to make sure that we'll find the PAW executable on the remote machine.

To check the presence of the file, issue:

```
> edg-rm --vo=tutor list gsiftp://grid007g.cnaf.infn.it/shared/tutor
```

To check the registration with the catalogue, we can do the following where LFN is the logical file name you want to search for:

```
> edg-rm --vo=tutor listReplicas -l LFN
```

FOLLOW-UP EXERCISE

Now that the file is registered on the SE with a given LFN, create another job where you specify the LFN as InputData in the JDL. Next, create a small job that reads the file specified by the LFN.

Hint: try to create a JDL that contains the following parts:

```
Executable = "my-job.pl";
Stdoutput = "stdoutoutput";
StdError = "stderrerror";
InputSandbox = {"my-job.pl"};
OutputSandbox = {"stdoutoutput", "stderrerror"};
InputData = {"lfn:my-test-lfn"};
DataAccessProtocol = {"file"};
VirtualOrganisation = "tutor";
```

Note that the file specified with “lfn:my-test-lfn” needs to exist. In the job “my-job.pl” use the file protocol to open the file and read it.

ADVANCED EXERCISE

As a related problem, to gain experience with the EDG Replica Manager inside jobs, try to do the same exercise involving the Storage Elements at other locations (see Exercise DM1 for information on how to obtain additional Storage Elements). In detail, modify the files edgRM.sh and edgRM.jdl accordingly.

3.9. EXERCISE DM-9: USE CASE - READ DATA ON THE GRID

Goal: In this exercise you are going to copy a file from a non Grid site to a remote SE. On replicating the file to various sites, you will retrieve the best file, read the contents and print it on the screen.

Note: In this exercise we only list a set of steps that will guide you through the use case. We do not provide a detailed list of commands but leave it as a challenge for you to solve the exercise in the best possible way.

This exercise requires the following steps:

3.9.1. PRE-USE CASE STEPS

These steps are necessary to set up the test data for the use case. You can either use the EDG Replica Manager based on R-GMA or based on the manual configuration file.

- Create a local test file.
- Place the test file on several SEs remote to the UI (or CE for a job) where you are working. [Hint: Use a specific LFN to keep track of the replicas. You will need the LFN later on.]

3.9.2. USE CASE STEPS

We assume that replicas are created at several remote SEs.

- Replicate the best file to the close SE. [Hint: use `getBestFile`]
- Extract the SFN from the SURL that is returned from `getBestFile`. [Hint: the SFN is the SURL without the prefix “`srm://`”]
- Obtain the TURL for the SURL. [Hint: use `getTurl`]
- Open the file for reading using the TURL.
- Print the file contents on the screen.

Notes: The use case will fail if there is no `closeSE`, so make sure that this is defined in R-GMA or in manual configuration files.

3.10. EXERCISE DM-10: USE CASE - COPY AND REGISTER JOB OUTPUT DATA

Goal: In this exercise you are going to write a job `job1` that produces several output files that are afterwards copied and registered to various SEs. Next you are going to write a second job that reads the best files of `job1` and prints the output on the screen. This is a typical use case of centralised data production where the result is distributed to various sites that are part of a particular Virtual Organisation. These production results are later analysed by users distributed all over the globe.

Note: In this exercise we only list a set of steps that will guide you through the use case. We do not provide a detailed list of commands but leave it as a challenge for you to solve the exercise in the best possible way.

The following steps are necessary for implementing this use case:

- Write a simple job `job1` that produces 5 output files with random numbers between 0 and 100.
- Copy and register these files to various SEs at the end of the job.
- Register metadata about file size, owner and description of the files.
- Write a second job `job2` that reads in the best files of `job1` and prints the output on the screen. [Hint: This step is similar to Exercise 9.]

3.11. EXERCISE DM-11: USE CASE - BULK DATA REGISTRATION

Goal: In this exercise you will perform a bulk data registration operation on files that are in a specific directory on an SE.

Note: In this exercise we only list a set of steps that will guide you through the use case. We do not provide a detailed list of commands but leave it as a challenge for you to solve the exercise in the best possible way.

There are several ways to reach this aim. One possibility is to use the replica manager command `bulkCopyAndRegisterFile`.

4. INFORMATION SERVICE EXERCISES

Information Systems provide to the Grid an up to date view of its resources, to allow their management and effective usage by users and internal Grid subcomponents.

The Information System deployed with EDG 2.x is R-GMA, Relational Grid Monitoring Architecture. This is a relational implementation of the GGF's GMA. This is not a general distributed RDBMS system, but a way to use the relational model in a distributed environment where global consistency is not important. Producers announce themselves with an SQL CREATE TABLE and publish data with an SQL INSERT. Consumers collect data using an SQL SELECT. Some Producers, the Registry and Schema make use of an RDBMS as appropriate; but what is central is the relational model.

A number of information providers have been produced by EDG. These are scripts which when invoked make available the desired information. The EDG information providers scripts cover Site Information, Computing Element, Storage Element and Network Monitoring. These scripts output data in LDIF format, a legacy from when the information system was based on LDAP. GIN (Gadget IN), periodically invokes these scripts and makes the data available via R-GMA.

Start the edg-rgma tool

```
edg-rgma
```

A couple of useful commands are

```
show tables
describe <table>
```

4.1. EXERCISE IS-1: WITH THE AID OF THE COMMAND LINE TOOL DISCOVER WHAT COMPUTING ELEMENTS ARE AVAILABLE ON THE TESTBED

```
latest select UniqueID from GlueCE
```

4.2. EXERCISE IS-2: DISCOVER THE AVAILABLE STORAGE ELEMENTS

```
latest select UniqueID from GlueSE
```

4.3. EXERCISE IS-3: EMULATE THE RESOURCE BROKER

In this example we perform some basic selection for the job, i.e. we emulate the Work Load Manager while performing the matchmaking process.

```
latest select UniqueID,TotalCPUs,WaitingJobs from GlueCE where WaitingJobs<9
```

4.4. EXERCISE IS-4: FIND OUT WHICH ARE THE RELATED STORAGE ELEMENTS

Now find the Storage Elements that are related to a Computing Element of your choice (substitute XXXX with a *UniqueID* obtained from the previous search).

```
latest select GlueSEUniqueID from GlueCESEBind where GlueCEUniqueID='XXXX'
```

4.5. EXERCISE IS-5: AVAILABLE SPACE ON THE STORAGE ELEMENT

Next find out how much available space the Storage Element has. You will need to substitute XXXX with a GlueSEUniqueID, use the value you obtained from the previous search.

```
latest select Root,AvailableSpace from GlueSA where GlueSEUniqueID='XXXX'
```

4.6. EXERCISE IS-6: JOINS

See if you can now combine the last 2 queries into 1 SQL statement.

4.7. EXERCISE IS-7: R-GMA BROWSER

The R-GMA Browser provides a web interface to the information and monitoring system. It is possible to examine the structure of the schema as well as the published data.

```
http://gppic02.gridpp.rl.ac.uk:8080/R-GMA/index.html }
```

Take some time to look at the browser, in particular the EDG-Information-Providers. See what types of producers are available for the GlueCE

Now have a look at the table for Service.

ADVANCED EXERCISE

Using either the Java or C++ API write a program that will publish records to this table at a configurable time interval using a StreamProducer. An extract from the “Users Guide” is included below. The full “Users Guide” can be found at:

```
http://hepunix.rl.ac.uk/edg/wp3/documentation/doc/guide/index.html
```

And the API guides can be found at:

```
http://hepunix.rl.ac.uk/edg/wp3/documentation/doc/api/java/index.html
```

and

```
http://hepunix.rl.ac.uk/edg/wp3/documentation/doc/api/cpp/index.html
```

Use the browser to check that you are publishing your data correctly.

An Archiver re-publishing to a LatestProducer for the Service table has already been instantiated and will be collecting information from all Producers. You should be able to see your data with a “Latest” query. Try modifying the data you are publishing and check the change propagates through to the “Latest” producer.

4.8. EXTRACT FROM THE USERS GUIDE - STREAMPRODUCER

In contrast to the DataBaseProducer and LatestProducer, the StreamProducer does not store tuples within a Database. Instead, published tuples are added to a buffer maintained by the StreamProducer mediator. As a result, the StreamProducer is not persistent between servlet container restarts.

When a tuple is published using a StreamProducer, the tuple is streamed to all connected Consumers. This approach therefore "pushes" tuples on to the Consumer creating a broadcast effect.

A Single StreamProducer can produce any number of tables. (Note - clarify, check only applies to StreamProducer when update document.)

To create a new StreamProducer use the following:

```
myProducer = new StreamProducer();
```

The next step is to declare a table for publishing tuples:

```
myProducer.declareTable
    ('`ServiceStatus`', # table name
     '`WHERE hostName = 'infocat.gridpp.rl.ac.uk`'', # predicate
     '`CREATE TABLE ServiceStatus (service VARCHAR(30))`') # create table
```

Although no data is stored within a database, declaring the table is still necessary to define the tuple content that will be published.

The setMaxBufferSize method is used to set the buffer size of the StreamProducer.

```
myProducer.setMaxBufferSize(1024);
```

To set the time-to-live value for the stored tuples, use the setMinRetentionPeriod method.

```
myProducer.setMinRetentionPeriod(new TimeInterval(1200));
```

To publish data, an SQL INSERT statement is used, which is passed as a parameter to the insert method:

```
myProducer.insert
    ('`INSERT INTO ServiceStatus # table name
     (hostName, name, VO, status, message) # columns
     VALUES ('infocat.gridpp.rl.ac.uk', 'GIN', 'Atlas', # values
              'OK','GIN is running')`')
```

When defining a termination interval for the StreamProducer, use the same setTerminationInterval method.

Note, when the StreamProducer is no longer required, be sure to call the undeclareTable and close method.

The following is example code from all available languages for the StreamProducer.

Java

```
myProducer = new StreamProducer();
myProducer.declareTable
    ('`ServiceStatus`', '`WHERE (hostName = 'infocat.gridpp.rl.ac.uk')`');
```

```
myProducer.setTerminationInterval(new TimeInterval(1200));
myProducer.setMaxBufferSize(1024);
myProducer.insert
    (``INSERT INTO ServiceStatus ``+
      ``(hostName, name, VO, status, message) ``+
      ``VALUES ('infocat.gridpp.rl.ac.uk', 'GIN', 'Atlas', 'OK', 'GIN is running')``);
myProducer undeclareTable(``ServiceStatus``);
myProducer.close();
```

C++

```
myProducer= new edg::info::StreamProducer();
myProducer->declareTable
    (``ServiceStatus``, ``WHERE (hostName = 'infocat.gridpp.rl.ac.uk')``);
myProducer->setTerminationInterval(new edg::info::TimeInterval(1200));
myProducer->setMaxBufferSize(1024);
myProducer->insert
    (``INSERT INTO ServiceStatus
      (hostName, name, VO, status, message)
      VALUES ('infocat.gridpp.rl.ac.uk', 'GIN', 'Atlas', 'OK', 'GIN is running')``);
myProducer->undeclareTable(``ServiceStatus``);
delete myProducer;
```

5. APPENDIX: ALTERNATIVE INFORMATION SERVICE: MDS

R-GMA is the official information service in the current EDG release. However, EDG software is also compatible with the Globus MDS information system. Below, you find some details on MDS.

Globus MDS 2.1 (Metacomputing Directory Service – now called Monitoring and Discovery Service) is a directory service based on the LDAP (Lightweight Directory Access Protocol). Directory Services are read-access optimized data bases; they are intended for systems with frequent read access rather than frequent write access. In Directory Services the complexity due to supporting transactions operation mode is avoided. LDAP is based on four models dealing with *Information, Naming, Functional and Security*. Data are organized in *Object Classes*, in a hierarchical object model, and all classes are derived from the *top* class. The LDAP server can be queried specifying the particular class of objects to be returned (using filters) and specifying the starting node – in the directory structure – from which we want to retrieve information. This is done by specifying the DN (*Distinguished Name*) of the starting node for the needed information. This is the *base* DN parameter of a LDAP search.

Entries have attributes, whose name can be specified in the query string. To describe in detail LDAP is out of the scope of this Tutorial. We want to show here just a few examples on how to get information from the Grid Information Systems.

All relevant resources run a LDAP daemon called *slapd*. As a convention Globus MDS uses port 2135.

Globus MDS is built on OpenLDAP. The Lightweight Directory Assess Protocol (LDAP) offers a hierarchical view of information in which the schema describes the attributes and the types of the attributes associated with data objects. The objects are then arranged in a Directory Information Tree (DIT).

A number of information providers have been produced. These are scripts which when invoked by the LDAP server make available the desired information. The information providers include Site Information, Computing Element, Storage Element and Network Monitoring scripts.

Within MDS the information providers are invoked by a local LDAP server, the Grid Resource Information Server (GRIS). “Aggregate directories”, Grid Information Index Servers (GIIS), are then used to group resources. The GRISs use soft state registration to register with one or more GIISs. The GIIS can then act as a single point of contact for a number of resources, i.e. a GIIS may represent all the resources at a site. In turn a GIIS may register with another GIIS, in which case the higher level GIIS may represent a country or a virtual organisation.

As MDS is based on LDAP, queries can be posed to the current Information and Monitoring Service using LDAP search commands. An LDAP search consists of the following components:

```
ldapsearch \
-x \
-LLL \
-H ldap://ced-ii0.datagrid.cnr.it:2135 \
-b 'Mds-Vo-name=datagrid,o=grid' \
'objectclass=ComputingElement' \
CEId FreeCPUs \
-s base|one|sub
```

Explanation of fields:

-x	"simple" authentication
-LLL	print output without comments
-H ldap://ced-ii0.datagrid.cnr.it:2135	uniform resource identifier
-b 'Mds-Vo-name=datagrid,o=grid'	base distinguished name for search
'objectclass=ComputingElement'	filter
CEId FreeCPUs	attributes to be returned
-s base	scope of the search specifying just the base object, one-level or the complete subtree

As another example, the main entry point in MDS is the Information Index that can then be queried. Please check with your tutor to get information about a valid information index. Below, there are some examples **but the hostnames are not correct names**:

```
ldapsearch -x -l 30 -L -h ced-ii0.datagrid.cnr.it -p 2170 \  
-b "mds-vo-name=local, o=grid" "objectclass=*"
```

The Information Index contains main relevant information concerning the various Computing Elements and Storage Elements (belonging respectively to the testbed) is provided in a formatted way.

To take a direct look at the registered Storage Elements on the Grid information published by the Grid information systems, one can query the MDS LDAP servers hosting the whole hierarchy of MDS GRIS/GIIS information belonging to the various national branches of MDS. In order to find out the name of the Grid top level MDS (ced-ii0.datagrid.cnr.it) please check the tutorial web page.

```
ldapsearch -x -l 30 -L -h ced-ii0.datagrid.cnr.it -p 2135 \  
-b "mds-vo-name=local, o=grid" "objectclass=*"
```

6. GLOSSARY

6.1. FILE NAMING CONVENTIONS

Throughout the tutorial you are confronted with several ways of naming files (Logical File Names, naming of replicas at Storage Elements etc.) and thus we give here the exact definitions and some examples. For the exercises you mainly use LFN and SURL.

LFN	Logical File Name	A Logical File Name is a user defined alias to a GUID. Unlike GUIDs, aliases are mutable but they still should be globally unique. Since the Replica Management System has no control over the creation of LFNs, this global uniqueness is only weakly enforced. Sometimes also the term Alias is used to refer to an LFN.
SURL	Storage URL	An SURL is a locator for a physical file, where the scheme specific part is understood by a Storage Resource Manager (SRM). It is a URL where the scheme is 'srm' and the host is a valid SRM host.
UUID	Universally Unique Identifier	A UUID is a 128 bits long number, and is either guaranteed to be different from all other UUIDs generated until 3400 A.D. or extremely likely to be different (depending on the mechanism chosen to generate it).
GUID	Grid Unique Identifier	A GUID generated by the Replica Management System for an SURL. It is created at the SURL registration time. A GUID is immutable.
TURL	Transport URL	A Transport URL is returned by a SRM in response to a request for a way to access a SURL. It includes the actual protocol you can access the SURL by. For instance, 'gsiftp' for GridFTP, or 'http' for HTTP access.

EXAMPLES

In the following we give examples for the definitions of naming conventions.

LFN examples:

```
lfn:mydata
lfn://any_name_you_want
```

SURL examples:

```
srm://host1.cern.ch/directory1/directory2/filename
srm://lxhare0384.cern.ch/flatfiles/cms/data/05/x.dat
```

GUID examples:

```
guid:73e16e74-26b0-11d7-b1e0-c5c68d88236a
guid:7c29f32b-4964-11d7-a86c-9ee9a33b1f19
```

TURL examples:

```
gsiftp://host1.cern.ch/directory1/directory2/filename
http://lxhare0384.cern.ch/flatfiles/cms/data/05/x.dat
```

6.2. ABBREVIATIONS AND EXPLANATIONS

Throughout the tutorial you will see several abbreviations that are summarised here and explained in some details. The list is not complete includes the most important items.

CE	Computing Element	A Computing Element is a Grid resource where jobs can be executed. In particular, the Computing Element can be regarded as the gateway that then further submits to one or more Worker Nodes in the same local area network.
ERM	EDG Replica Manager	The client interface to all RMS operations. This consists of a set of command-line tools.
LRC	Local Replica Catalog	The catalog storing GUID to SURL mappings, along with SURL attributes for a given site, or a single Storage Resource Manager at a site. It only stores GUID to SURL mappings for SURLs that are actually located in the given site or SRM.
RLI	Replica Location Index	The catalog storing information about which Local Replica Catalogs have GUID to SURL mappings for a particular GUID. It thus provides the link between different LRCs, allowing for distributed indexing and querying of the Catalogs.
RLS	Replica Location Service	The distributed service providing the mappings between GUIDs and SURLs. An RLS has two components: Local Replica Catalogs and Replica Location Indexes.
SE	Storage Element	A Grid Service where files can be stored and registered with a catalog.
SRM	Storage Resource Manager	A Storage Resource Manager takes care of managing storage that can either be a single disk, a disk pool (farm), a hierarchical storage system, a tape system etc. and provides a unique interface to it.
VO	Virtual Organization	Every user needs to be part of a certain community (or organisation). Since it does not necessarily need to exist, it is called a “virtual organisation”. All people taking part in an EDG tutorial are part of the VO “tutor”.
WMS	Workload Management System	Set of services that takes care of accepting user jobs, finding a match based on the job requirements, and then submit a job for execution to a Computing Element.

ACKNOWLEDGEMENTS

We want to thank many different people belonging to various EDG work packages, who contributed with example material, suggestions or assistance in the set up of the exercises.

This work was partially funded by the European Commission program IST-2000-25182 through the EU DataGrid Project.