

LCG PEB, 1 June 2004

“The ARDA project: status report”

Massimo Lamanna

<http://cern.ch/arda>



E-G-EE
Enabling Grids for
E-science in Europe
www.eu-egee.org



Contents

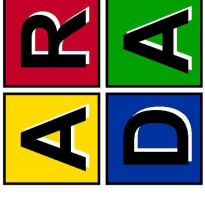

- ARDA Project status
 - Installation
 - Planning of activity
 - Activity (so far and plans)
 - Experiment software
 - Experiment prototypes
 - Forum activities



People

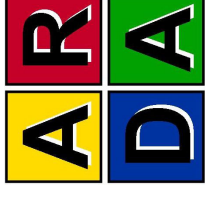

- Massimo Lamanna
- Birger Koblitz

- Dietrich Liko
- Frederik Orellana

- Derek Feichtinger
- Andreas Peters

- Julia Andreeva
- Juha Herrala

- Andrew Maier
- Kuba Moscicki

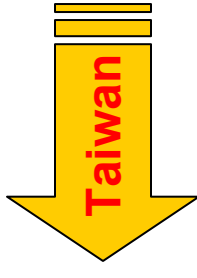
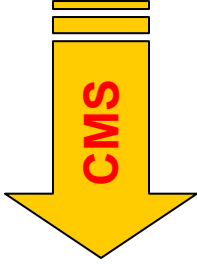

- Andrey Demichev
- Viktor Pose

- Wei-Long Ueng
- Tao-Sheng Chen

Experiment interfaces

Piergiorgio Cerello (ALICE)
David Adams (ATLAS)
Lucia Silvestris (CMS)
Ulrik Egede (LHCb)

Logistics and installation in bd. 510

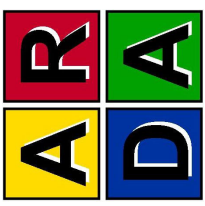

- Technicalities and preliminary installation solved
 - Erwin Mosselmans
 - John Harvey
 - John Fergusson
- Final installation more or less completed
 - Not easy...
 - End of April, all people had a desk close to bd.510
- Probably a bit more space would be necessary
 - PhD students (over 2...)
 - F. Harris
 - Room for visitors (more coming?)
 - At least 2/3 phone conferences a week

Preliminary activities

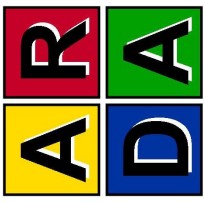

- Existing system as starting point
 - Every experiment has different implementations of the standard services
 - Used mainly in production environments
 - Few expert users
 - Coordinated update and read actions
 - ARDA
 - Interface with the EGEE middleware
 - Verify (help to evolve to) such components to analysis environments
 - Many users
 - » Robustness
 - » Concurrent “read” actions
 - » Performance
- One prototype per experiment
 - A Common Application Layer might emerge in future
 - ARDA emphasis is to enable the experiment to do its job

Glite “disclosed” May 18th ☺

Since the beginning

Time consuming (see next section)

Milestone	Date	Description
1.6.2-5	May 2004	E2E x prototype definition agreed with the experiment
1.6.6-9	September 2004	E2E x prototype using basic EGEE middleware
1.6.14-17	November 2004	E2E x prototype using basic EGEE middleware
1.6.18	December 2004	E2E prototype for experiment x, capable of analysis
1.6.19	December 2005	E2E prototype for experiment x, capable of analysis and production

All ARDA milestones

LHCb

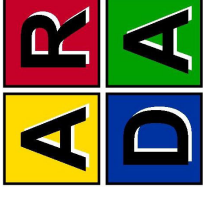

- The LHCb system within ARDA uses GANGA as principal component.
- The LHCb/GANGA plans:
 - enable physicists (via GANGA) to analyse the data being produced during 2004 for their studies
 - It naturally matches the ARDA mandate
 - Have the prototype where the LHCb data will be the key (CERN, RAL, ...)
- At the beginning, the emphasis will be to validate the tool focusing on usability, validation of the splitting and merging functionality for users jobs
- The DIRAC system (LHCb grid system, used mainly in production so far) could be a useful playground to understand the detailed behaviour of some components, like the file catalog. Convergence between DIRAC and GANGA foreseen.

ARDA contribution to Ganga

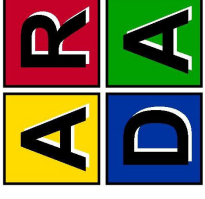

- Integration with EGEE middleware
 - Waiting for the EGEE middleware, we developed an interface to Condor
 - Use of Condor DAGMAN for splitting/merging and error recovery capability
- Design and Development
 - Command Line Interface
 - Future evolution of Ganga
- Release management
 - Software process and integration
 - Testing, tagging policies etc.
 - Infrastructure
 - Installation, packaging etc.
 - It looks to be effective!

LHCb Metadata catalog

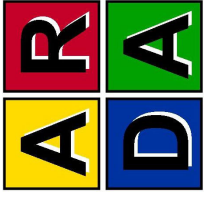

- Used in production (for large productions)
- Web Service layer being developed (main developers in the UK)
- Oracle backend
- ARDA contributes a “testing” focused on the analysis usage
 - Robustness
 - Performances under high concurrency (read mode)

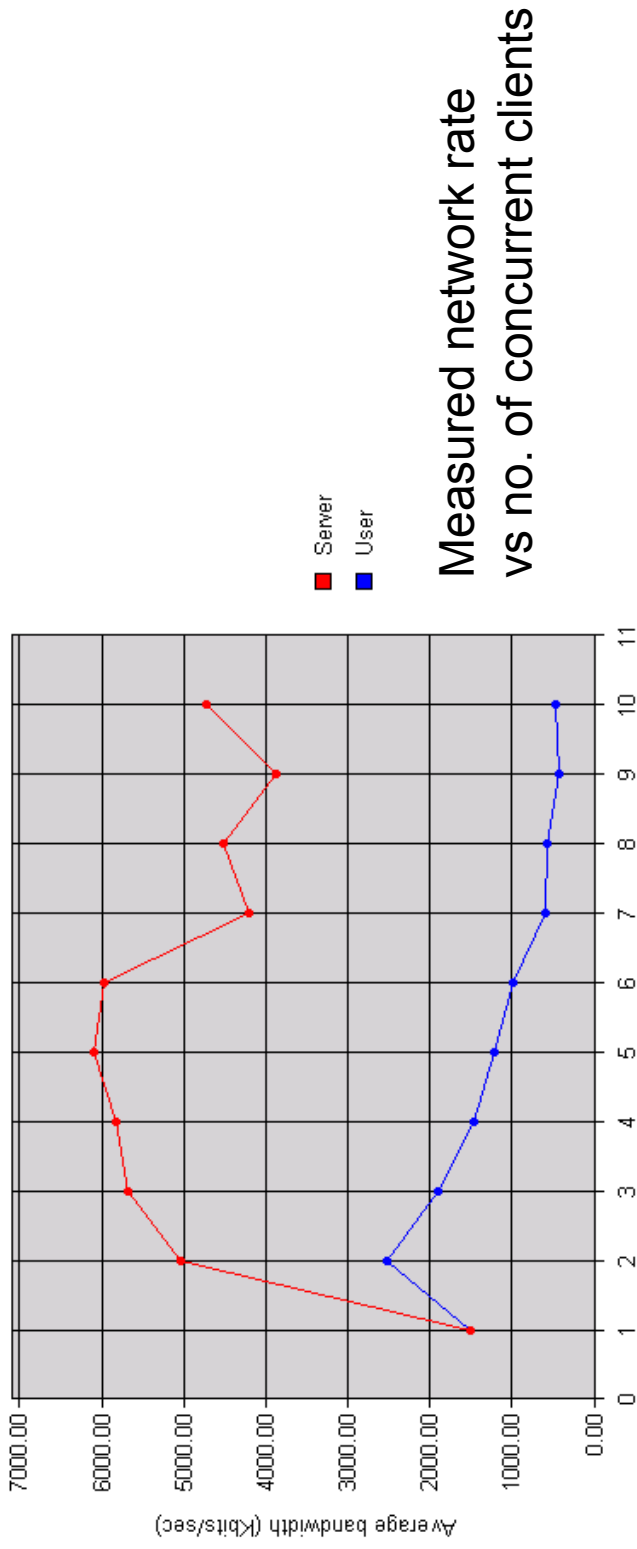

CERN/Taiwan tests

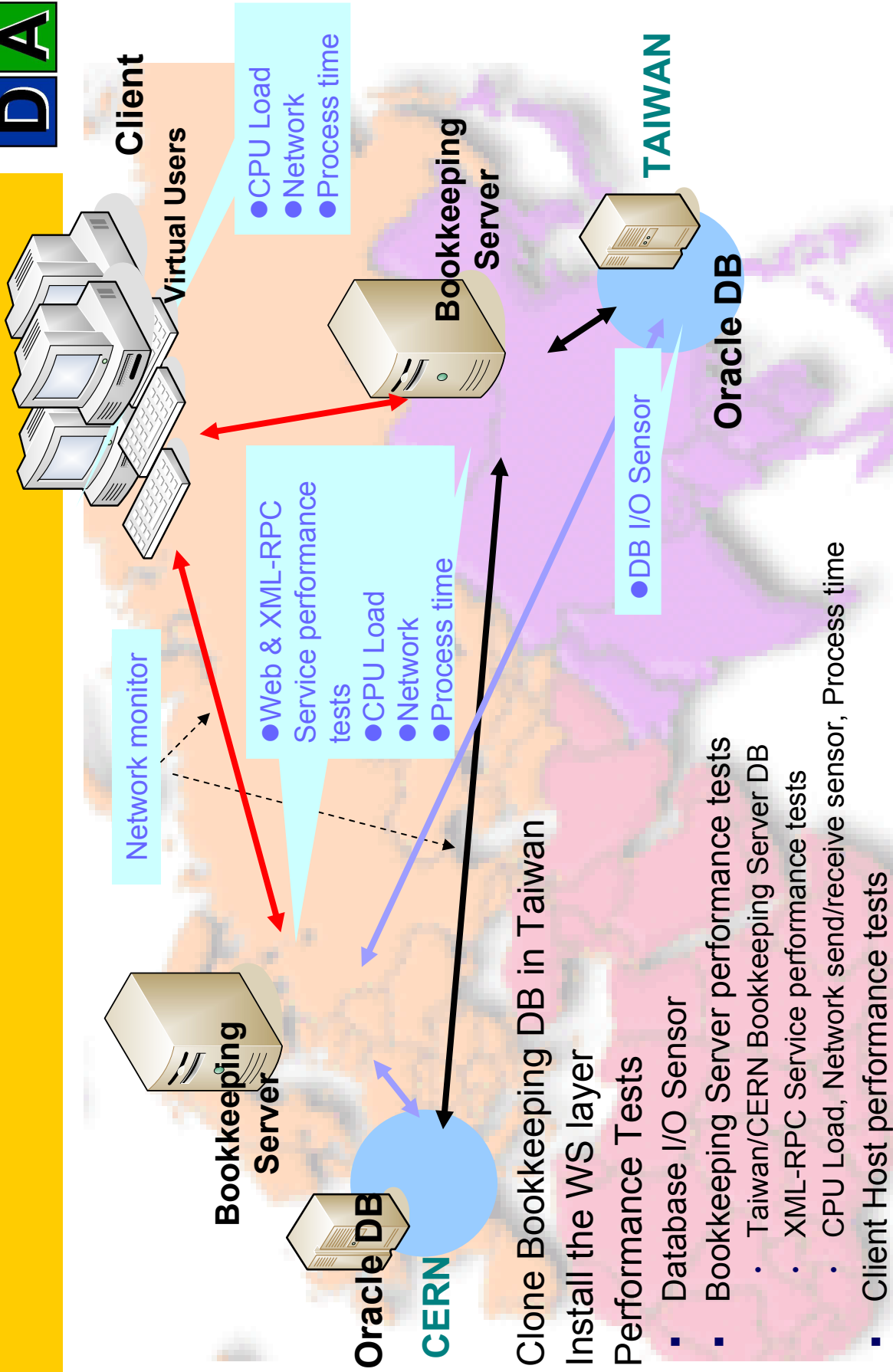

- Clone Bookkeeping DB in Taiwan
- Install the WS layer
- Performance Tests
 - Database I/O Sensor
 - Bookkeeping Server performance tests
 - Taiwan/CERN Bookkeeping Server DB
 - XML-RPC Service performance tests
 - CPU Load, Network send/receive sensor, Process time
 - Client Host performance tests
 - CPU Load, Network send/receive sensor, Process time

ALICE

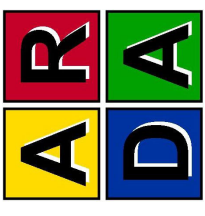

- Strategy:
 - The ALICE/ARDA will evolve the analysis system presented by ALICE at SuperComputing 2003
- Where to improve:
 - Heavily connected with the middleware services
 - “Inflexible” configuration
 - No chance to use PROOF on federated grids like LCG in AliEn
 - User libraries distribution
- Activity on PROOF
 - Robustness
 - Error recovery

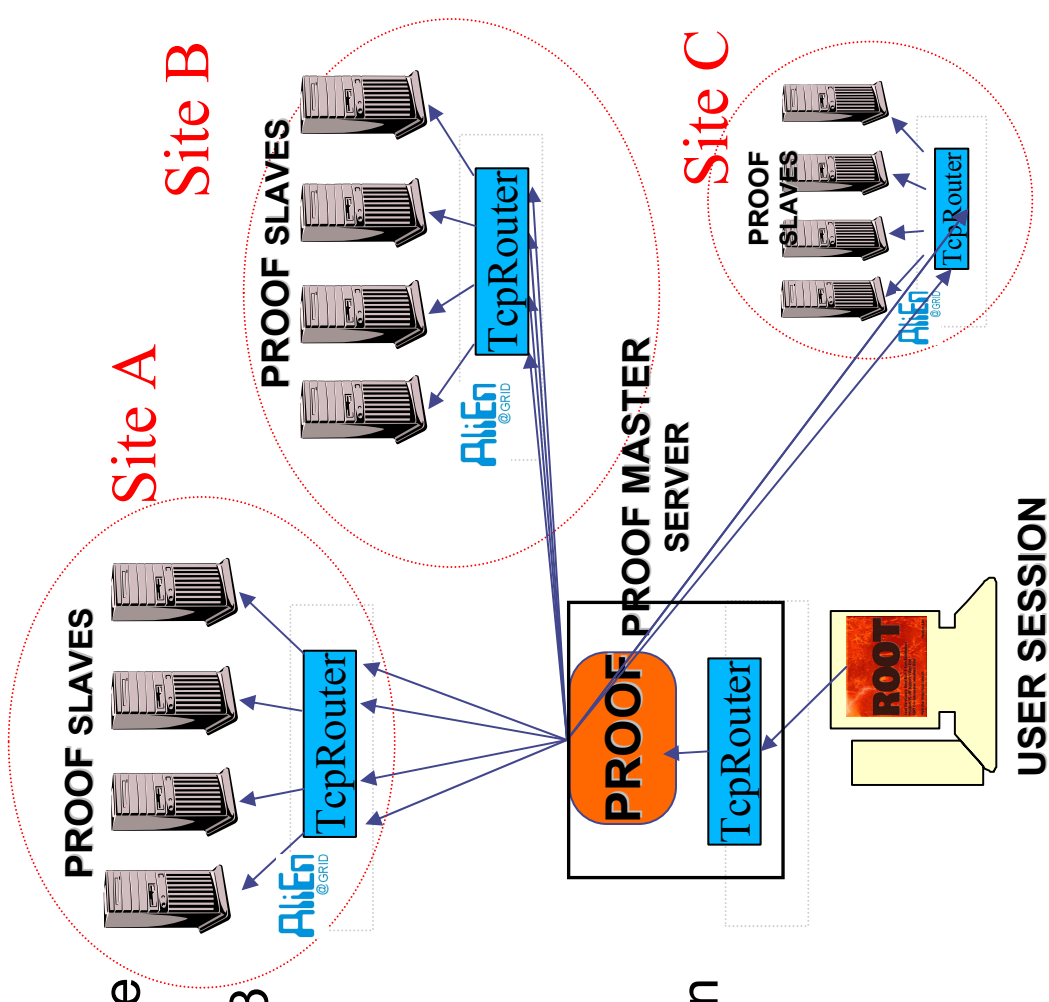

ALICE-ARDA improved system

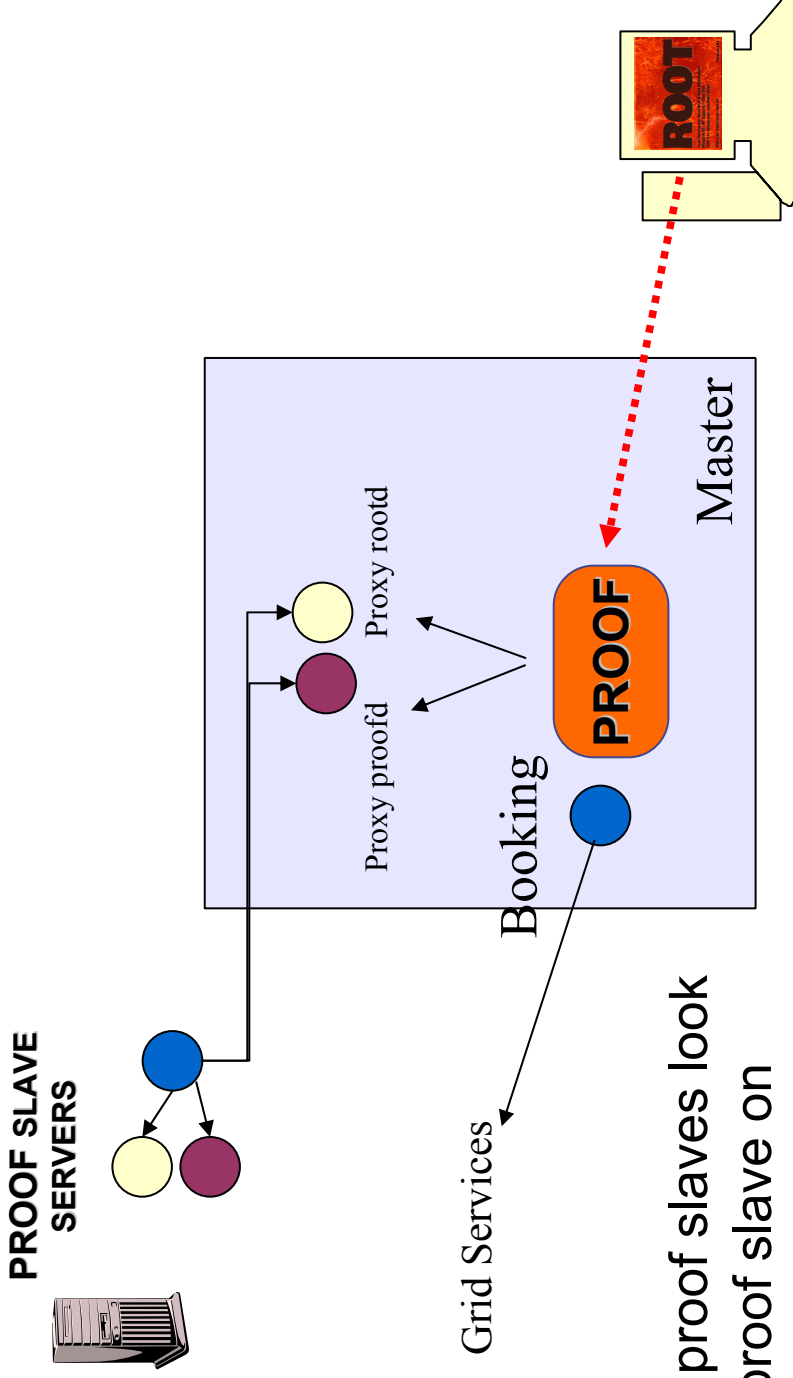
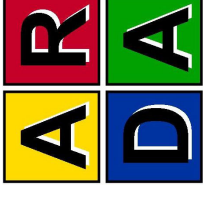

- The remote proof slaves look like a local proof slave on the master machine
- Booking service is usable also on local clusters

ATLAS

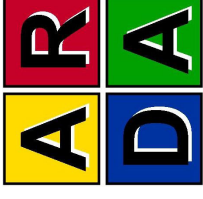

- The ATLAS system within ARDA has been agreed
 - ATLAS has a complex strategy for distributed analysis, addressing different areas with specific projects (Fast response, user-driven analysis, massive production, etc...: see <http://www.usatlas.bnl.gov/ARDA/>)
 - Starting point is the DIAL analysis model system
- The AMI metadata catalog is a key component
 - MySQL as a back end
 - Genuine Web Server implementation
 - Robustness and performance tests from ARDA
- In the start up phase, ARDA provided some help in developing ATLAS production tools
 - Being finalised

AMI studies in ARDA

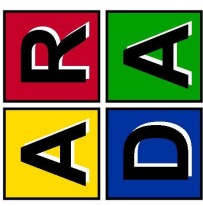

- Atlas Metadata- Catalogue, contains **File Metadata**:
 - Simulation/Reconstruction-Version
 - **Does not contain physical filenames**
- Many problems still open:
 - Large network traffic overhead due to schema independent tables
 - SOAP proxy supposed to provide DB access
 - Note that Web Services are “stateless” (not automatic handles to have the concept of session, transaction, etc...): 1 query = 1 (full) response
 - Large queries might crashed server
 - Shall proxy re-implement all database functionality?
- Good collaboration in place with ATLAS-Grenoble

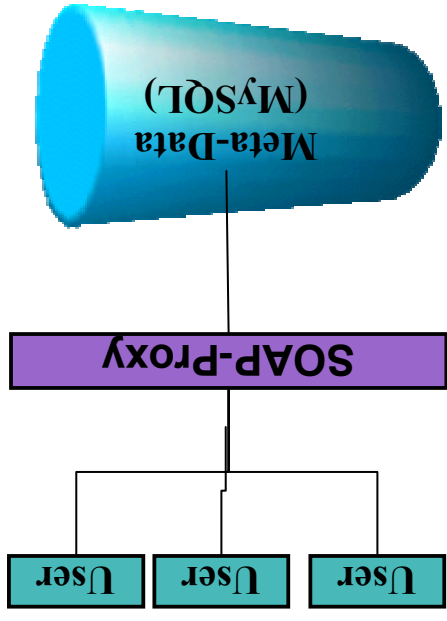

Studied behaviour using **many concurrent clients**:

Clients	Rows in Response										
	5	10	20	50	100	150	5	10	20	50	
1	0.22	0.27	0.35	0.87	2.49	5.26					
5	0.40	0.48	0.74	2.94	10.99	27.98					
10	0.67	0.75	1.74	4.77	21.99	56.17					
20	1.02	1.34	2.46	9.51	41.79	timeout					
30	1.42	2.36	3.10	14.21	66.61	timeout					
40	1.80	2.33	4.84	19.94	timeout	timeout					
50	2.32	6.43	5.02	21.43	timeout	timeout					
100	9.94	9.82	SOAP-Err	SOAP-Err	SOAP-Err						
150	16.51	SOAP-Err									

- The CMS system within ARDA is still under discussion
- Provide easy access (and possibly sharing) of data for the CMS users is a key issue

- RefDB is the bookkeeping engine to plan and steer the production across different phases (simulation, reconstruction, to some degree into the analysis phase)
- It contained all necessary information except file physical location (RLS) and info related to the transfer management system (TMDB)
- The actual mechanism to provide these data to analysis users is under discussion
- Measuring performances underway (similar philosophy as for the LHCb Metadata catalog measurements)

RefDB in CMS DC04

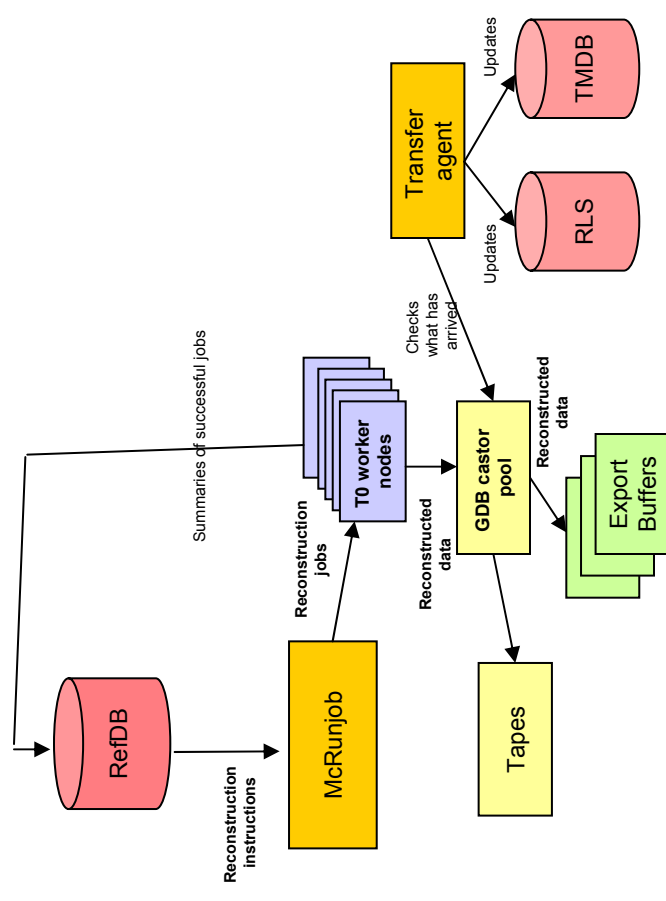

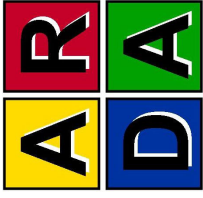

CMS refDB tests

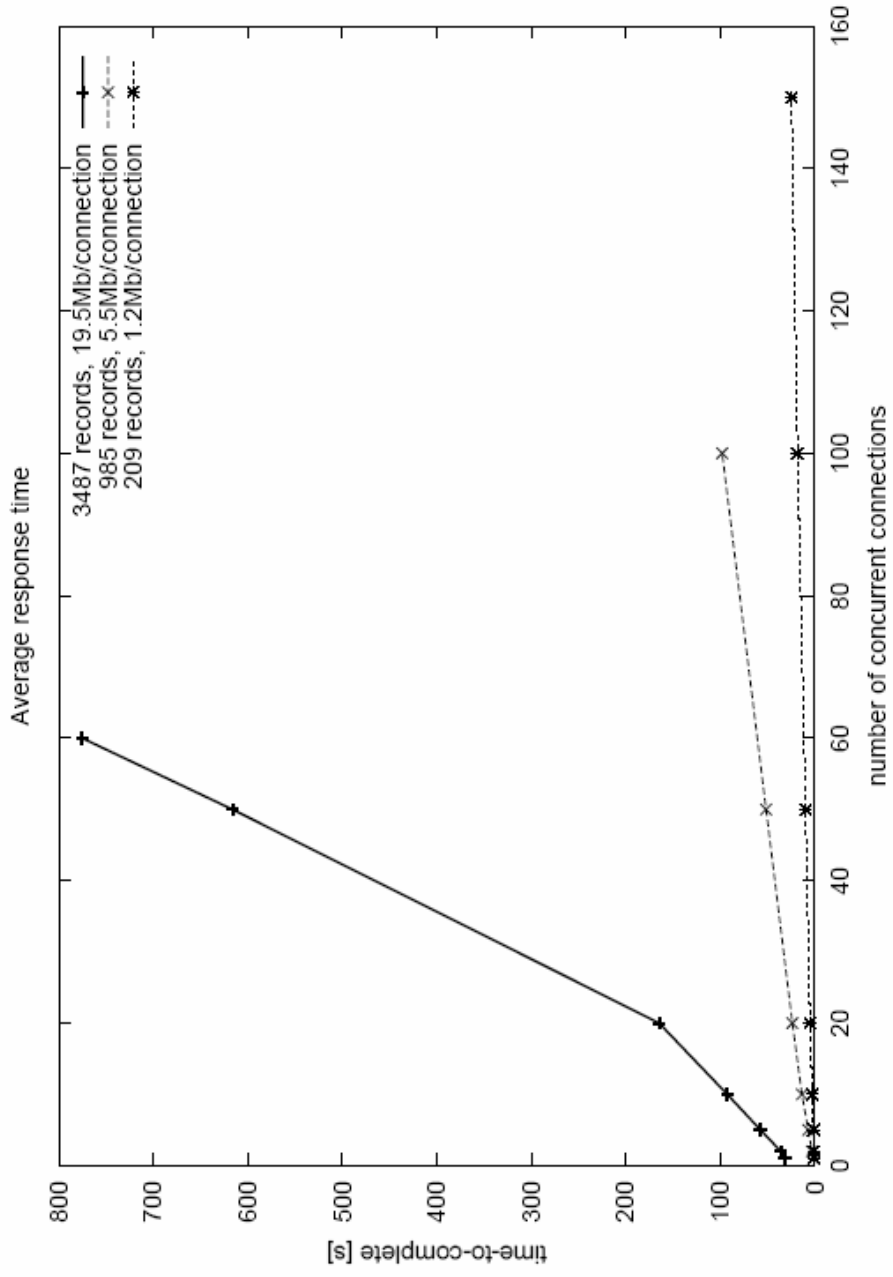
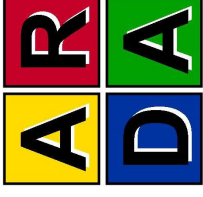

Figure 1: The average time-to-complete of a request presented as a function of the number of concurrent queries. The collections were described in the Table 1.

LHCb status



- Easy to agree on the prototype
 - Naturally aligned with the GANGA plans
 - Just started to play with Glite
- Other contributions
 - GANGA technical contribution
 - LHCb metadata catalogue measurements
 - Taiwan (ARDA + local DB know-how on Oracle)
 - DIRAC
 - Coherent evolution with Ganga
 - Expose DIRAC experience in the ARDA workshop

ALICE status

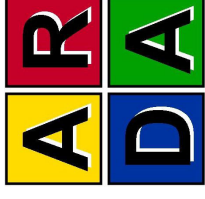

- Easy to agree on the prototype
 - Evolution of SC2003
 - Just started to play with Glite
- Other contributions
 - Investigate/survey Data Transfer protocols (comparison with RFIO, gridFTP... emphasis on robustness, error recovery and security)
 - PROOF (starting)
 - ROOTD (feedback loop closed)
 - AIOD (to be done)
 - XROOTD (to be done)
 - AliEn testing (activity started before ARDA, now completed; info handed over also to EGEE JRA1)

ATLAS status

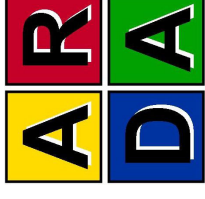

- Difficult to agree on the prototype
 - ATLAS complex strategy
 - Major role of the DIAL model agreed
 - Minimal system as a starting point (run ATHENA jobs on a local cluster)
- Other contributions
 - Production system (activity started before ARDA; finishing)
 - ATLAS metadata catalogue measurements
 - Mainly at CERN (on the ARDA side)
 - Nice collaboration (feedback) with ATLAS Grenoble (S. Albrandt et al.)
 - DIAL
 - Exercise with the old DIAL version

CMS status

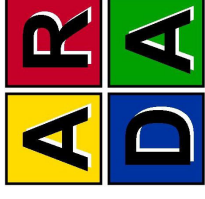

- Difficult to agree on the prototype
 - CMS complex strategy
 - Major role of the catalogues
 - RefDB (metadata)
 - RLS (replica location)
 - POOL catalogues
 - Agreement before the ARDA workshop!
- Other contributions
 - Production system (new usage of COBRA metadata in RefDB)
 - RefDB catalogue measurements
 - Mainly at CERN (on the ARDA side)
 - Nice collaboration with many CMS people: exploratory work (share/agree on tests etc...)

HEP/Grid and ARDA

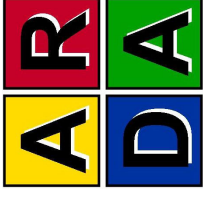

- LCG GAG
 - Massimo invited to be in the GAG: 1 per month
 - GAG has the key role to keep the HEP requirements/use cases
 - No duplication
 - ARDA contribution is complementary
 - NA4 LHC representative sit in GAG (Piergiorgio, Laura, Claudio, Andrey)
- Many invitations
 - HEP
 - DESY
 - gridPP (RAL and CERN)
 - GGF in Honolulu... (postponed to GGF Brussels if useful)

Difficult message: NA4 HEP mandate is to support the LHC experiments in using the Grid. A loosely coupled collaboration is possible on specific subjects, like metadata.

“The first 30 days of the EGEE middleware” ARDA workshop

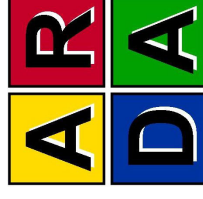

- CERN: 21-23 of June 2004
- Monday, June 21
 - ARDA team / JRA1 team
 - ALICE (Interactivity on the Grid)
- Tuesday, June 22
 - LHCb (Experience in building web services for grid)
 - ATLAS (Metadata database services for HEP experiments)
- Wednesday, June 23
 - CMS (Data management)
 - Close out

“The first 30 days of the EGEE middleware” ARDA workshop

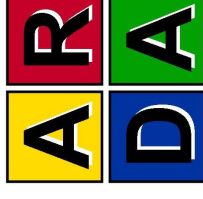

- Effectively, this is the 2nd workshop (January '04 workshop)
- Given the new situation:
 - Glite middleware becoming available
 - LCG ARDA project started
 - Experience + need of technical discussions
- New format:
 - “Small” (30 participants vs 150 in January)
 - To have it small, by invitation only...
 - ARDA team + experiments interfaces
 - EGEE Glite team (selected persons)
 - Experiments technical key persons (2-3 times 4)
 - Technology experts (Dirk, Fons, Iosif, Rene)
 - NA4/EGEE links (4 persons, Cal Loomis included)
- Info on the web:
 - http://lcg.web.cern.ch/LCG/peb/arda/LCG_ARDA_Workshops.htm

Workshop activity

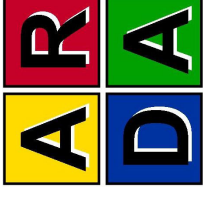

- 1st ARDA workshop (January 2004 at CERN; open)
- 2nd ARDA workshop (June 21-23 at CERN; by invitation)
 - “The first 30 days of EGEE middleware”
- NA4 meeting mid July
 - NA4/JRA1 and NA4/SA1 sessions organised by M. Lamanna and F. Harris
- 3rd ARDA workshop (September 2004?; open)

- “Forum activities” are fundamental (see LCG ARDA project definition), on the other hand there are no milestones proposed for this (removed a proposed one)

EGEE and ARDA

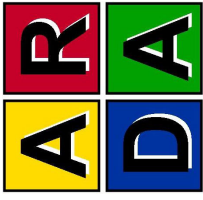

- Strong links already established between EDG and LCG. It will continue in the scope of EGEE
- The core infrastructure of the LCG and EGEE grids will be operated as a single service, and will grow out of LCG service
 - LCG includes many US and Asia partners
 - EGEE includes other sciences
 - Substantial part of infrastructure common to both
- Parallel production lines as well
 - LCG-2
 - 2004 data challenges
 - Pre production prototype
 - EGEE MW
 - ARDA playground for the LHC experiments

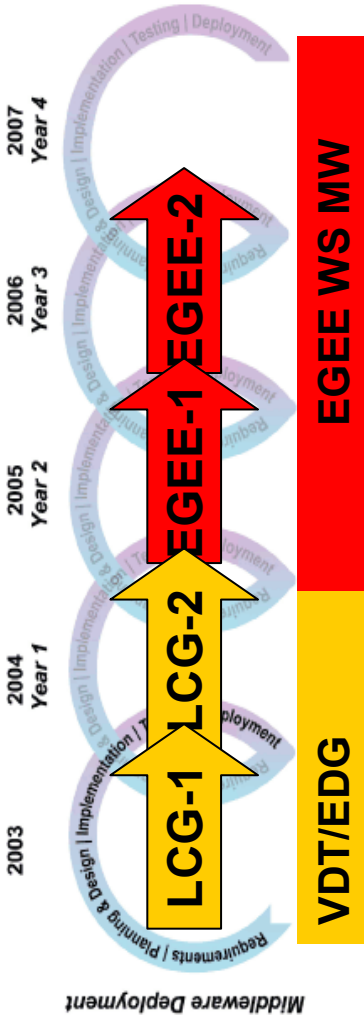
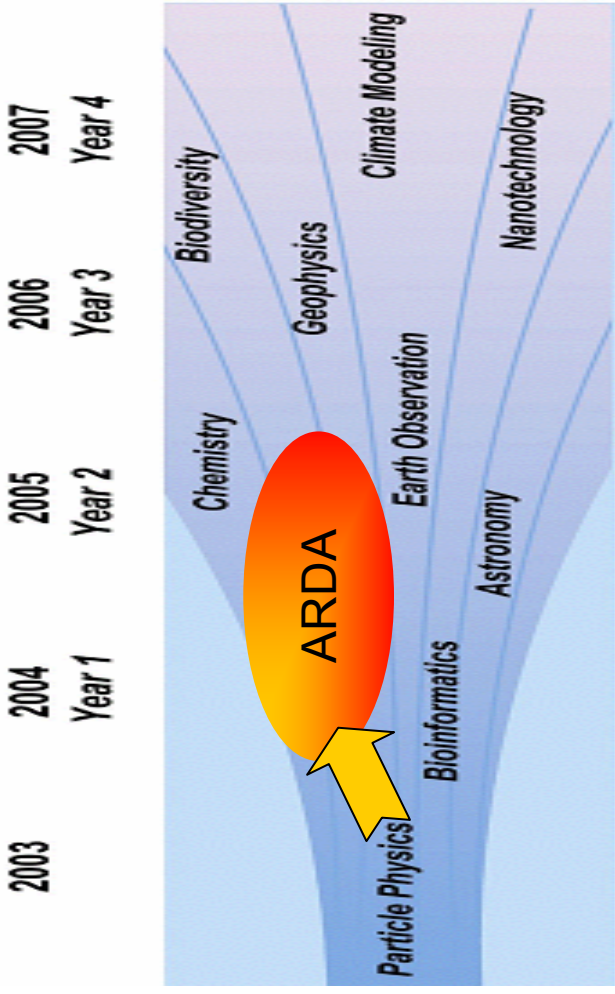

EGEE and ARDA

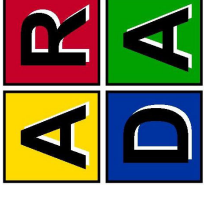

- EGEE/LCG effort to ARDA
 - 4 FTE from EGEE
 - NOW: 6 LCG + 4 persons from regional centres
- EGEE Conferences: 2 per year. April = Cork; Ireland
 - Not too efficient (could not attend to the full conference; maybe next one more interesting)
 - Opportunity to meet people outside the LCG circle
- EGEE “All Activity Meetings”: several a year?
 - First one (for me) June 18th
- NA4 AWG (Application working group): 1 meeting per week (Massimo and Frank)
 - NA4 steering body
 - Nice atmosphere, clearly the goals are not always the same for all (not a surprise)
 - ARDA should be there
- EGEE PEB: 1 meeting per week (Frank)
 - Excellent relation with Frank
- EGEE PTF (Project Technical Forum): 1 per month (Massimo and Jeff Templon)
 - New body. First meeting June 17th. Close to the Architecture Team (alias?). It reports to the Technical Director. Convener: Cal Loomis
 - ARDA should be there. I hope concrete technical issues will dominate the discussion
- NA4 meeting in Catania (mid July):
 - JRA1/NA4: organised by Massimo
 - I would like to use it as another ARDA workshop (benefiting from non-LHC ideas and experience)
 - SA1/NA4: organised by Frank
 - Very important (preproduction service)

ARDA @ Regional Centres

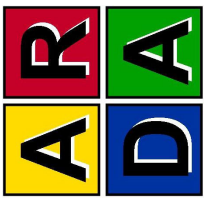

- “Deployability” is a key factor of MW success
- A few Regional Centres will have the responsibility to provide early installation for ARDA to supplement the LCG preproduction service
- Stress and performance tests could be ideally located outside CERN
 - This is for experiment-specific components (e.g. a Meta Data catalogue)
 - Leverage on Regional Centre local know how
 - Data base technologies
 - Web services
 - ...
- Ease the interaction with “the rest of” HEP?
 - DESY
 - Non LHC experiments?
- Running ARDA pilot installations
 - Experiment data available where the experiment prototype is deployed
 - CERN, RAL, all Tier1s... The strategy is not clear yet
- As for the “Forum activities”, no milestones proposed for these activities

Status

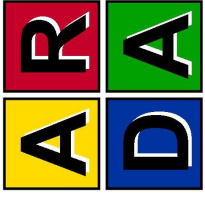

- **Prototype definition**
 - 3 out of 4 OK (1 milestone late)
- **Prototype status**
 - ALICE and LHCb OK
 - ATLAS/DIAL “starting point” not yet available
- **EGEE Middleware**
 - GLite software available 😊
- **EGEE**
 - Useful contacts
 - Sizable but manageable overhead so far