

Spacetime Physics

Similar story for the open string (all Neumann):

$$A_\mu(x)$$

$$\int_{\partial\mathcal{M}} d\tau A_\mu \partial_t X^\mu$$

Coupling to boundary
of the worldsheet.

$$S = -\frac{C}{4} \int d^D X e^{-\Phi} \text{Tr} F_{\mu\nu} F^{\mu\nu} + O(\alpha')$$

Effective spacetime action
is Maxwell, with coupling
set by dilaton.

g_s^{-1} “disc order”

of boundaries

Pert. theory is $g_s^{-\chi}$ where now $\chi = 2 - 2h - b$

Spacetime Physics

When there are Dirichlet-Dirichlet and Dirichlet-Neumann directions also, there is a more geometrical language:

$$A_\mu(x)$$

“D-branes”

D-Branes

Think of open string sectors as existing within a closed string theory, as hypersurfaces called “D-branes”, where the endpoints lie.

p extended directions:

D p -brane

$p+1$ Neumann directions
 $D-p-1$ Dirichlet directions

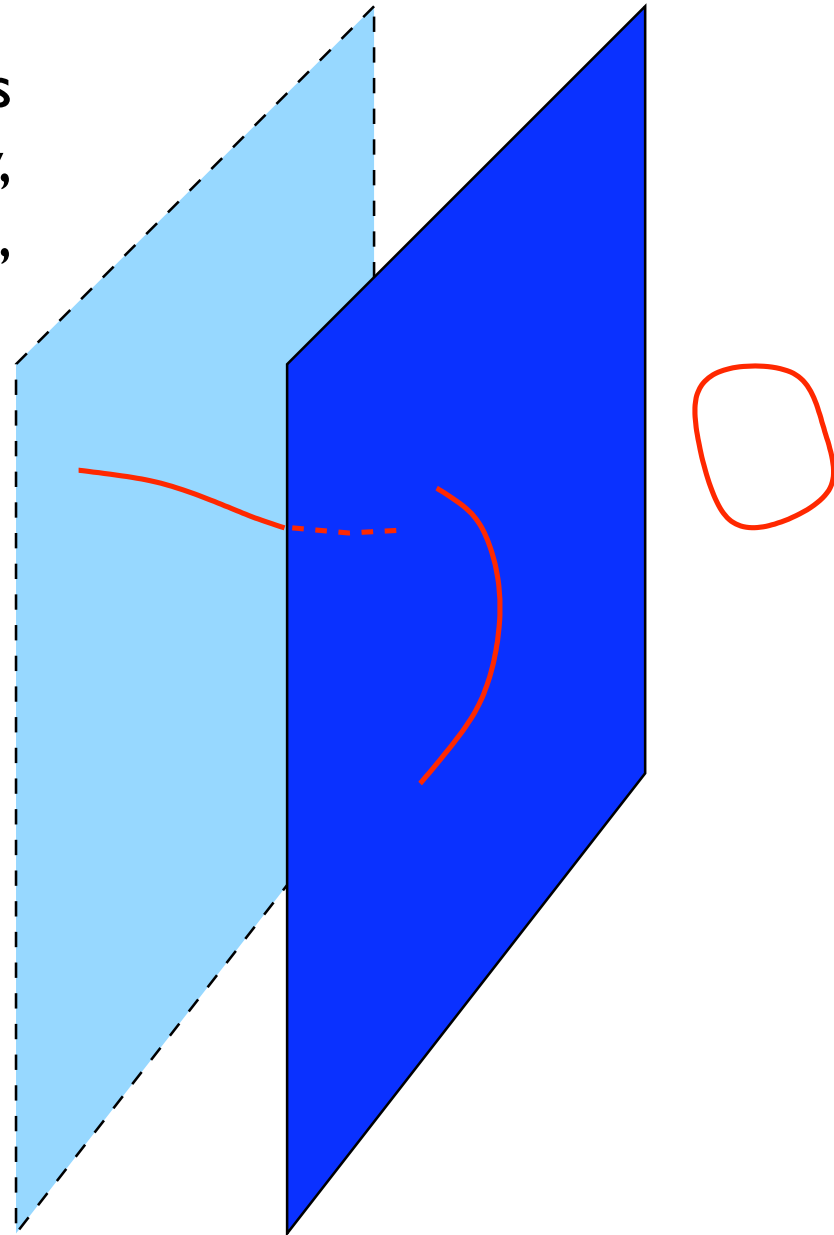

D-Branes

Open string degrees of freedom give a $U(1)$ gauge theory in the $(p+1)$ -dimensions of its “worldvolume”

Vibrations of DN-strings and DD-strings appear as (charged) scalars in this world-volume theory.

p extended directions:

Dp -brane

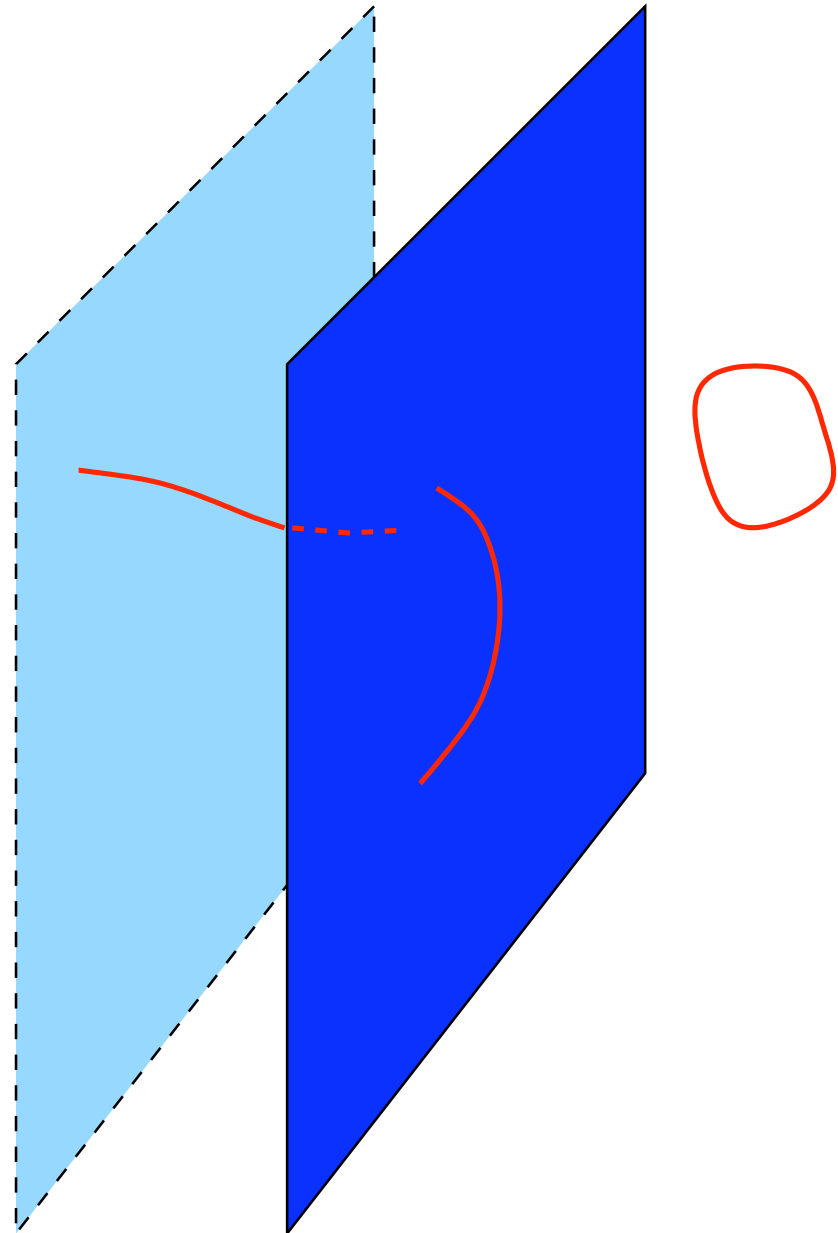

Multiple branes:

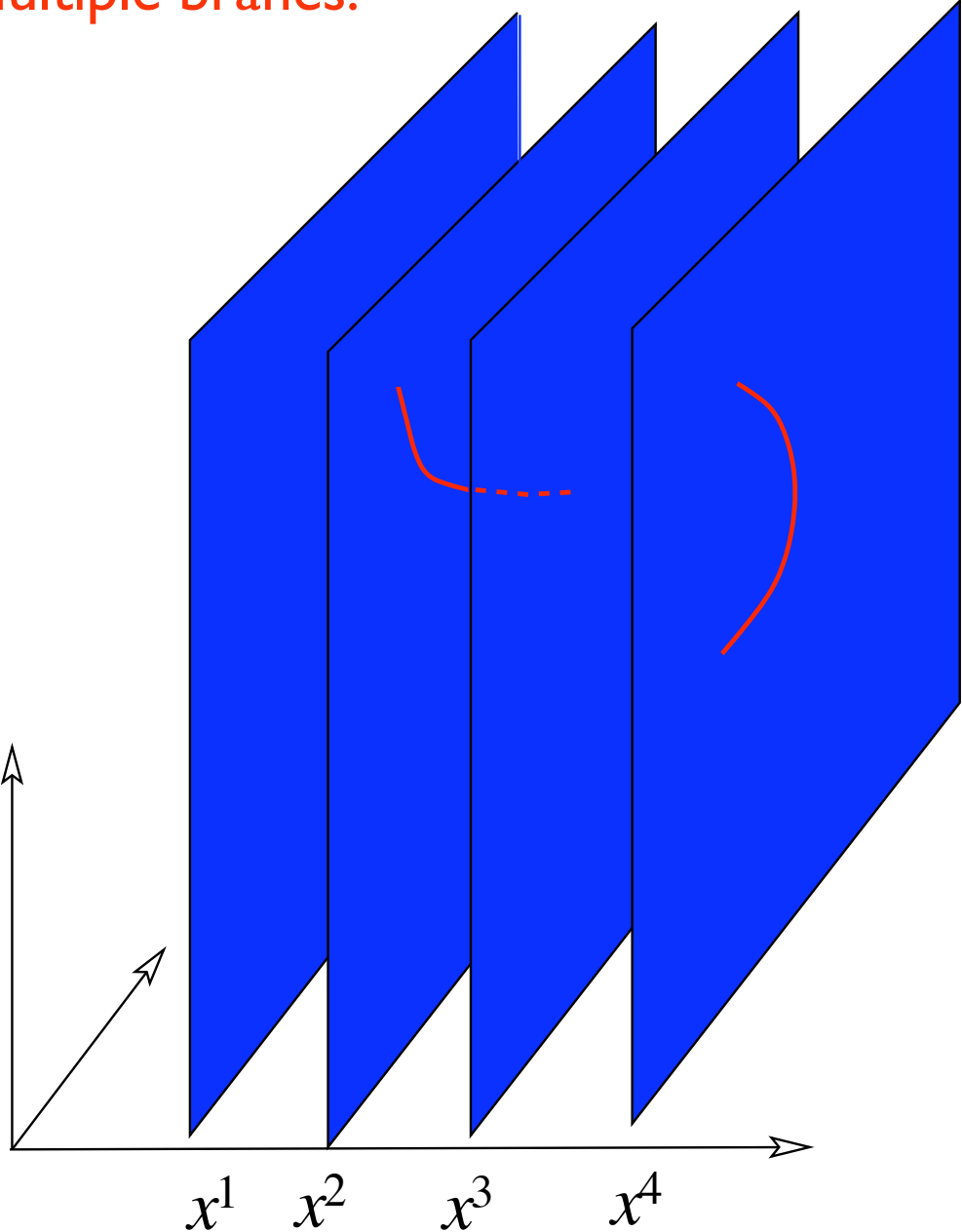

$SU(N)$ gauge theory
on world-volume instead

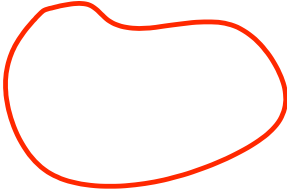

Multiple branes:

Pulling branes apart is a Higgs mechanism, from worldvolume perspective:

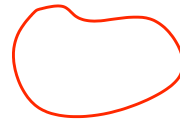
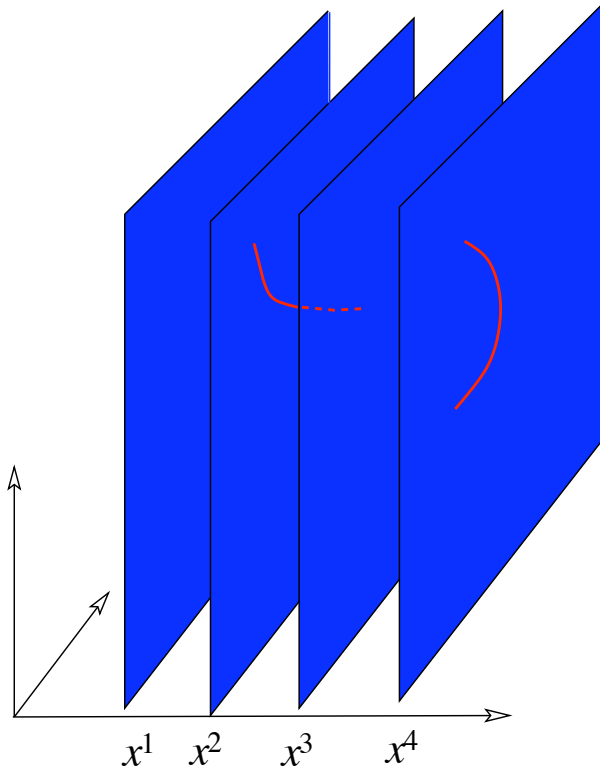

Some fields get vevs

Transverse flucts of strings with both ends on same brane

Some fields get masses

Transverse flucts of strings with ends on different branes

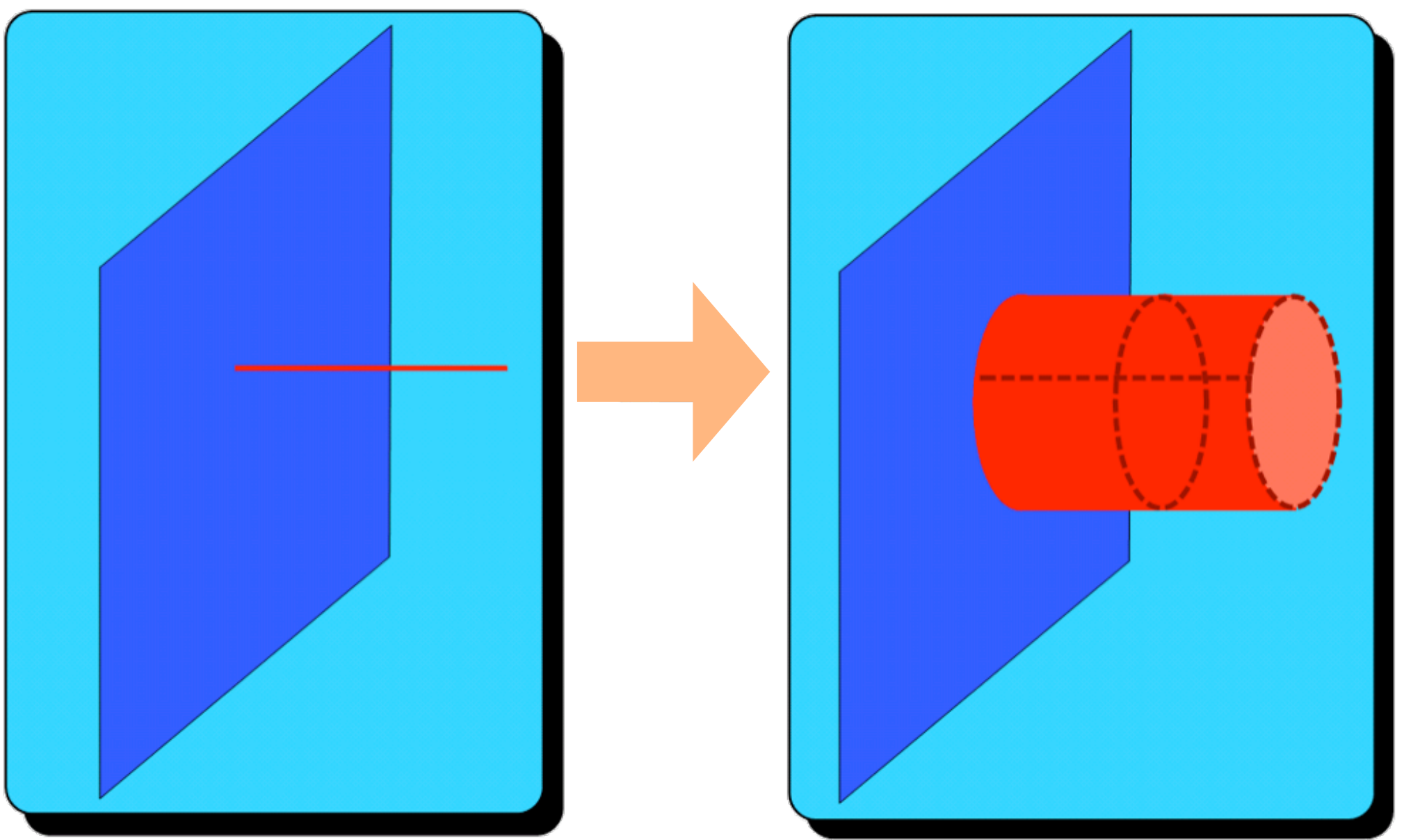

Within the open/closed description, one can describe the D-branes' natural sourcing of closed string fields.

$$G_{\mu\nu}, \Phi$$

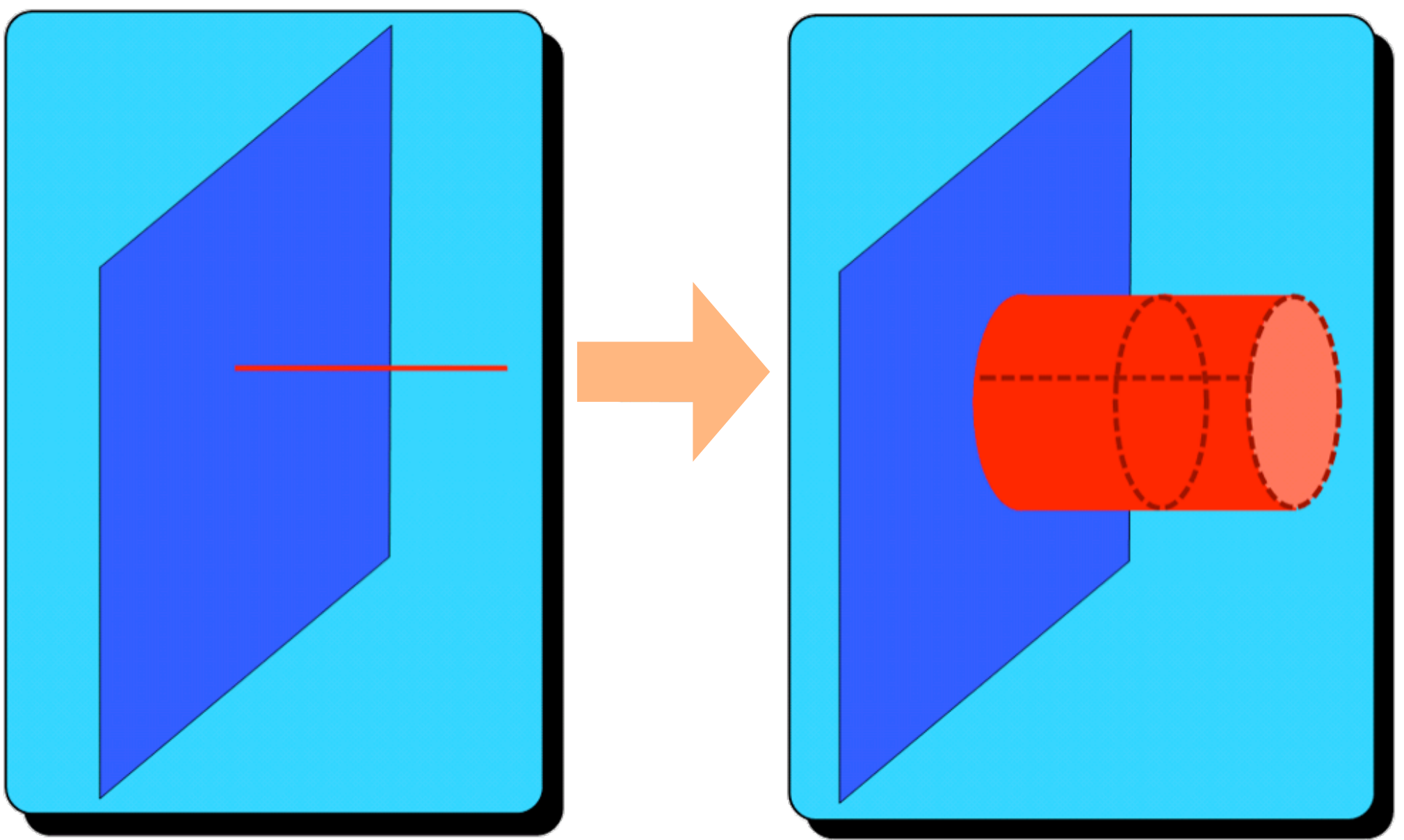

Sourcing gravity shows them to be genuine dynamical objects with mass per unit volume (tension).

$$G_{\mu\nu}, \Phi$$

Their tension can be explicitly computed using such diagrams, to fix constant C shown earlier:

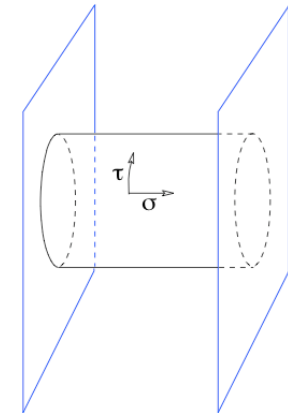

$$S_p = -T_p \int d^{p+1}\xi e^{-\Phi} \det^{1/2}(G_{ab} + B_{ab} + 2\pi\alpha' F_{ab})$$



intrinsic coordinates
on D-brane

$$T_p = \frac{\sqrt{\pi}}{16\kappa_0} (4\pi^2 \alpha')^{(11-p)/2}$$

“pull-back” of G, B

$$G_{ab} \equiv \frac{\partial X^\mu}{\partial \xi^a} \frac{\partial X^\nu}{\partial \xi^b} G_{\mu\nu}$$

physical tension
goes inversely with
string coupling:

$$\tau_p = \frac{T_p}{g_s}$$

(Get from this Dirac-Born-Infeld action to the Yang-Mills seen earlier by working at low energy.)

$$C = (2\pi\alpha')^2 T_{D-1}$$

Supersymmetric Strings

Easy to state what happens now that we have all the tools

Pretty similar story, with some extra wrinkles:

The “critical dimension” is $D=10$

The tachyon is not present

There are additional families of fields in the massless spectra

The basic closed strings are:

Type IIA

Type IIB

Heterotic

Heterotic

Can place D-branes (and other objects called “orientifolds” into these two)



Can place objects called “NS5-branes” into all of these theories

Can make the prototype open string theory:

Type I

More later!

Taking Stock

We've developed a great deal of the language of perturbative string theory.

We've seen several positive features:

The theory describes Quantum Gravity
The theory describes Gauge Theories

They fit into the same framework!

The theory generates its coupling dynamically
Only adjustable parameter seems to be one basic length scale

But there are several features of concern:

We had no means of describing how the theory generates its vacua
Had to place it into different solutions by hand
Are there non-perturbative subtleties/mechanisms which radically modify the picture?

How do we get a grip on non-perturbative features...?

Properties of D-Branes

Clifford V. Johnson
Physics and Astronomy
University of Southern California

Academic Training Lectures
CERN, 6th - 10th June 2005



This Section's Goal

To focus more on properties of D-branes:

to better understand Type II strings

to further sharpen the language

to let them show us the way to strong coupling

To set the scene for:

various special topics

various current events....

Describing Strings

Recall that we learned how to describe strings in the last section:

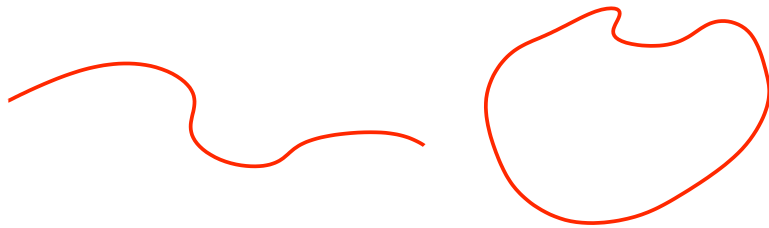

A key thing we brought out was the fact that strings have a massless sector of excitations, that we can in fact use to characterize the string somewhat.

The Gap

The String Spectrum has a tunable gap, set by its tension... Making that large (say, Planck Scale) is equivalent to taking a low energy limit...

...finding perhaps our world.

string tension:

$$T = \frac{1}{2\pi\alpha'}$$

defines a length scale

$$\frac{1}{\alpha'}$$

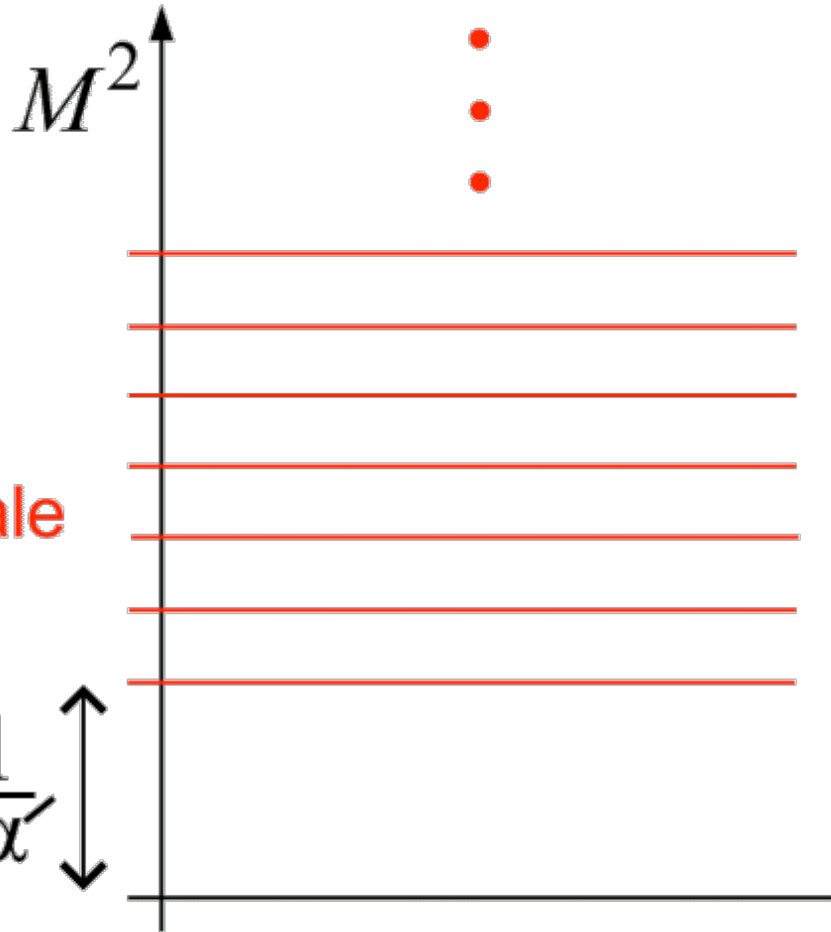

spectrum has massless sector, then a gap

The Gap

The low energy limit really does mean that we look at scales below which the string is “stringy” and instead see it as a variety of particles.

This is how we make contact with field theory...

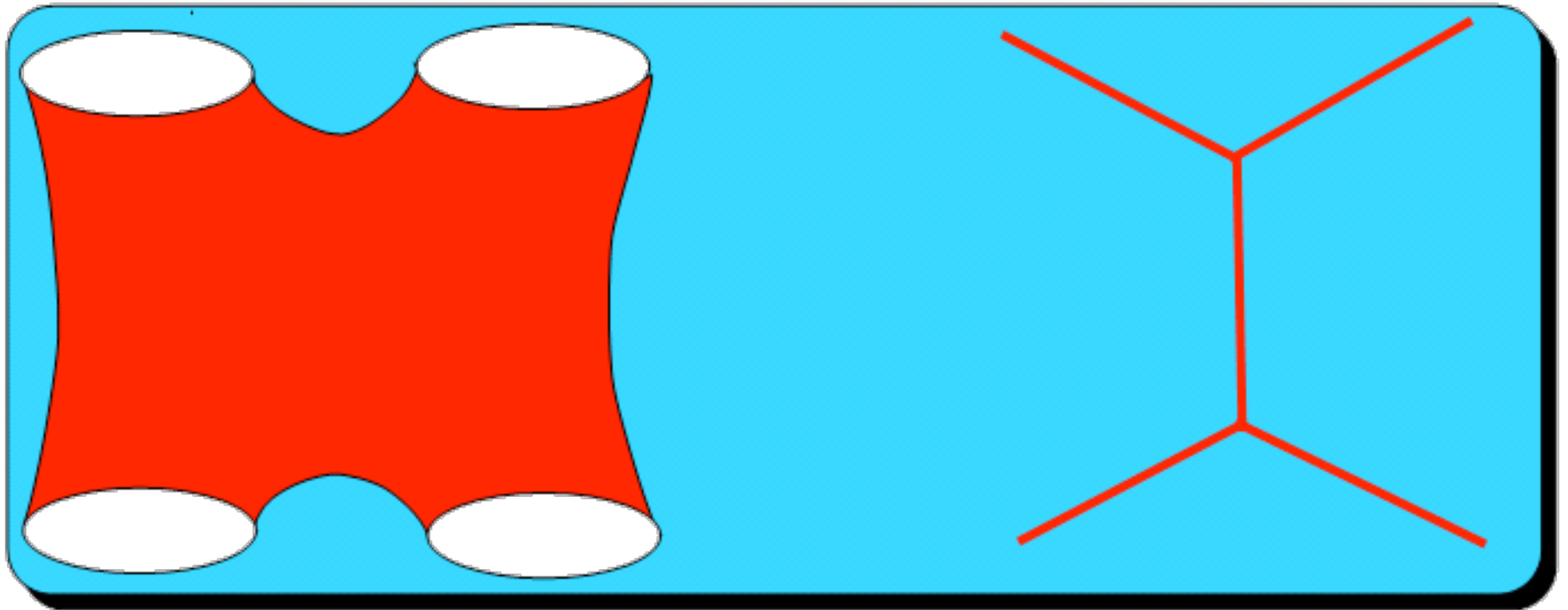

Supersymmetric Strings

We can describe the supersymmetric string theories in the same way. Describe the content of their massless sector.

We won't have a lot of time to set up the language of supersymmetry, so this is a good alternative.

Supersymmetric Strings

Well, here they are:

Name	O/C	Comments	Content (low energy massless fields)
Type IIA	(closed)	Very (super) symmetric ($N=2$)	$G_{\mu\nu}, B_{\mu\nu}, \Phi$ $C_\mu, C_{\mu\nu\kappa}, C_{\mu\nu\kappa\sigma}$
Type IIB	(closed)	Very (super) symmetric ($N=2$)	$C, C_{\mu\nu}, C_{\mu\nu\kappa\sigma}$
Heterotic ($E8 \times E8$) Heterotic ($SO(32)$)	(closed) (closed)	Less (super) symmetric ($N=1$) Less (super) symmetric ($N=1$)	$G_{\mu\nu}, B_{\mu\nu}, \Phi$ A_μ
Type I ($SO(32)$)	(open)	Less (super) symmetric ($N=1$)	$G_{\mu\nu}, C_{\mu\nu}, \Phi, A_\mu$

Supersymmetric Strings

The fields in black are from the “NS-NS” sector

The fields in red are from the “R-R” sector

Name	O/C	Comments	Content (low energy massless fields)
Type IIA	(closed)	Very (super) symmetric ($N=2$)	$G_{\mu\nu}, B_{\mu\nu}, \Phi$ $C_{\mu}, C_{\mu\nu\kappa}, C_{\mu\nu\kappa\sigma}$
Type IIB	(closed)	Very (super) symmetric ($N=2$)	$C, C_{\mu\nu}, C_{\mu\nu\kappa\sigma}$
Heterotic ($E_8 \times E_8$)	(closed)	Less (super) symmetric ($N=1$)	$G_{\mu\nu}, B_{\mu\nu}, \Phi$
Heterotic ($SO(32)$)	(closed)	Less (super) symmetric ($N=1$)	A_{μ}
Type I ($SO(32)$)	(open)	Less (super) symmetric ($N=1$)	$G_{\mu\nu}, C_{\mu\nu}, \Phi, A_{\mu}$

The language describes combining different types of left and right moving sectors to get spacetime field.

NS has anti-periodic world-sheet fermions
R has periodic world-sheet fermion

Supersymmetric Strings

The heterotic strings have a gauge field coming from a special mechanism for closed strings called “enhanced gauge symmetry”. It’s like Kaluza-Klein, (and employs a hidden T^{16}) but better, since it uses strings’ ability to wind as well.

Name	O/C	Comments	Content (low energy massless fields)
Type IIA	(closed)	Very (super) symmetric ($N=2$)	$G_{\mu\nu}, B_{\mu\nu}, \Phi$ $C_{\mu}, C_{\mu\nu\kappa}, C_{\mu\nu\kappa\sigma}$
Type IIB	(closed)	Very (super) symmetric ($N=2$)	$C, C_{\mu\nu}, C_{\mu\nu\kappa\sigma}$
Heterotic (E8xE8)	(closed)	Less (super) symmetric ($N=1$)	$G_{\mu\nu}, B_{\mu\nu}, \Phi$
Heterotic (SO(32))	(closed)	Less (super) symmetric ($N=1$)	A_{μ}
Type I (SO(32))	(open)	Less (super) symmetric ($N=1$)	$G_{\mu\nu}, C_{\mu\nu}, \Phi, A_{\mu}$

The Type I string has a gauge field coming from N-N open strings, as we described before. Think of there being several D9-branes, filling all of D=10. There’s also an “orientifold” projection.

Supersymmetric Strings

The string theories all have effective actions for the massless fields. Usually called “supergravity”. For example:

$$S_{\text{IIA}} = \frac{1}{2\kappa_0^2} \int d^{10}x (-G)^{1/2} \left\{ e^{-2\Phi} \left[R + 4(\nabla\Phi)^2 - \frac{1}{12} (H^{(3)})^2 \right] - \frac{1}{4} (G^{(2)})^2 - \frac{1}{48} (G^{(4)})^2 \right\} - \frac{1}{4\kappa_0^2} \int B^{(2)} dC^{(3)} dC^{(3)} .$$

$$2\kappa^2 \equiv 2\kappa_0^2 g_s^2 = 16\pi G_N = (2\pi)^7 \alpha'^4 g_s^2$$

The G is a field strength of a C , with its rank denoted as superscript.

Supersymmetric Strings

The string theories all have effective actions for the massless fields. Usually called “supergravity”. For example:

$$S_{\text{IIA}} = \frac{1}{2\kappa_0^2} \int d^{10}x (-G)^{1/2} \left\{ e^{-2\Phi} \left[R + 4(\nabla\Phi)^2 - \frac{1}{12}(H^{(3)})^2 \right] - \frac{1}{4}(G^{(2)})^2 - \frac{1}{18}(G^{(4)})^2 \right\} - \frac{1}{4\kappa_0^2} \int B^{(2)} dC^{(3)} dC^{(3)} .$$

Notice that the dilaton factor showing what order in string perturbation theory we were at only appears here....Not for R-R sector

Yes, this is a clue.

Supersymmetric Strings

Name	O/C	Comments	Content (low energy massless fields)
Type IIA	(closed)	Very (super) symmetric ($N=2$)	$G_{\mu\nu}, B_{\mu\nu}, \Phi$ $C_\mu, C_{\mu\nu\kappa}, C_{\mu\nu\kappa\sigma}$
Type IIB	(closed)	Very (super) symmetric ($N=2$)	$C, C_{\mu\nu}, C_{\mu\nu\kappa\sigma}$
Heterotic (E8xE8)	(closed)	Less (super) symmetric ($N=1$)	$G_{\mu\nu}, B_{\mu\nu}, \Phi$
Heterotic (SO(32))	(closed)	Less (super) symmetric ($N=1$)	A_μ
Type I (SO(32))	(open)	Less (super) symmetric ($N=1$)	$G_{\mu\nu}, C_{\mu\nu}, \Phi, A_\mu$

Supersymmetric Strings

Name	O/C	Comments	Content (low energy massless fields)
Type IIA	(closed)	Very (super) symmetric ($N=2$)	$G_{\mu\nu}, B_{\mu\nu}, \Phi$ $C_{\mu}, C_{\mu\nu\kappa}, C_{\mu\nu\kappa\sigma}$
Type IIB	(closed)	Very (super) symmetric ($N=2$)	$C, C_{\mu\nu}, C_{\mu\nu\kappa\sigma}$
Heterotic ($E_8 \times E_8$)	(closed)	Less (super) symmetric ($N=1$)	$G_{\mu\nu}, B_{\mu\nu}, \Phi$
Heterotic ($SO(32)$)	(closed)	Less (super) symmetric ($N=1$)	A_{μ}
Type I ($SO(32)$)	(open)	Less (super) symmetric ($N=1$)	$G_{\mu\nu}, C_{\mu\nu}, \Phi$ A_{μ}

Notice that they all have a metric, two-index antisymmetric tensor, and a dilaton.

Why is there always that Multiplet?

Whenever there's a closed string, there'll always be that multiplet.

Recall:

$G_{\mu\nu}$ is the graviton

Φ sets the local value of the string coupling: $g_s = e^\Phi$

Why is there an anti-symmetric field though?

$$B_{\mu\nu} = -B_{\nu\mu}$$

It is there to give dynamical weight to the string's ability to wind.

Why is there always that Multiplet?

B is there to give dynamical weight to the string's ability to wind.

Particle

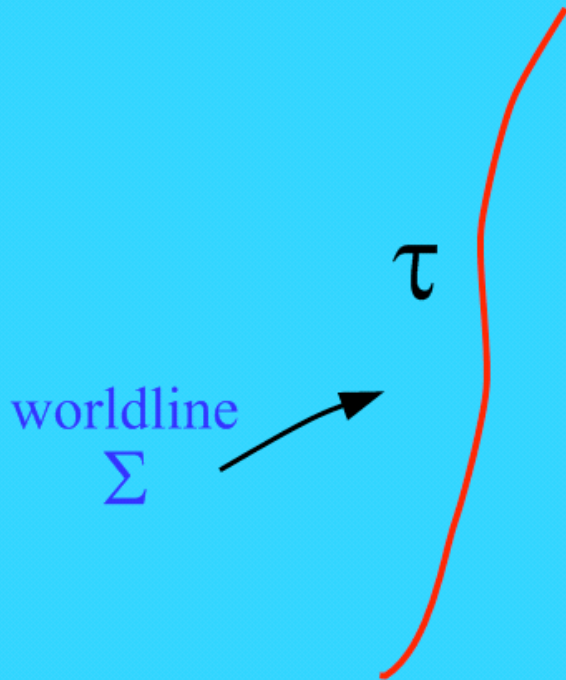

$$\int_{\Sigma} A = \int d\tau \frac{\partial X^{\mu}}{\partial \tau} A_{\mu}$$

String

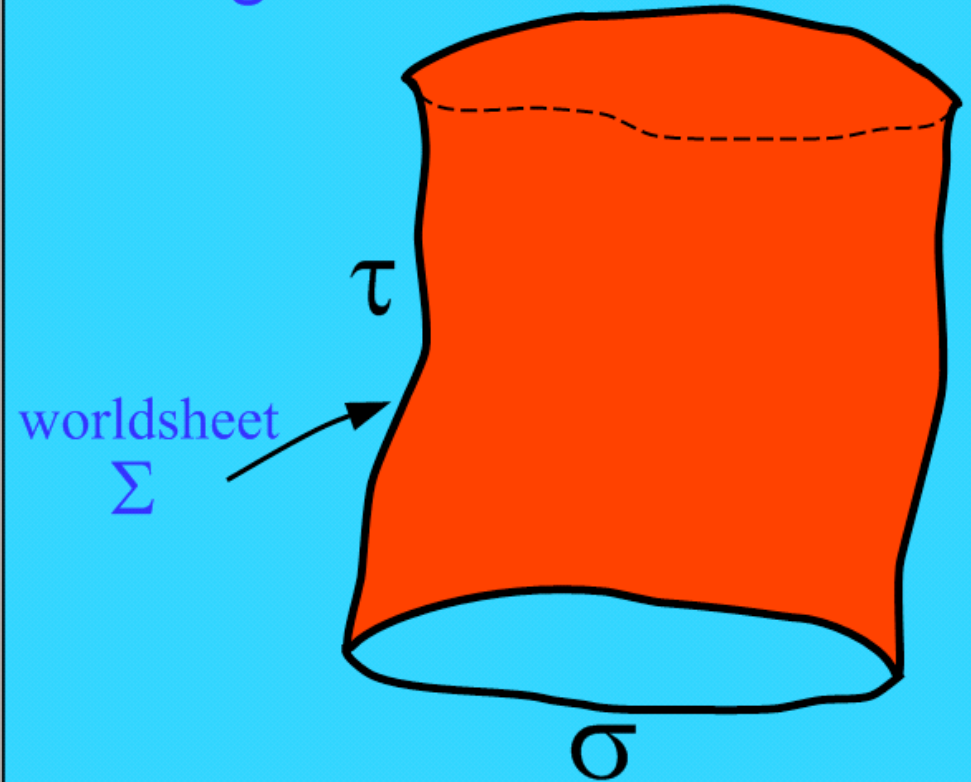

$$\int_{\Sigma} B = \int d^2\sigma \varepsilon^{ab} \frac{\partial X^{\mu}}{\partial \sigma^a} \frac{\partial X^{\nu}}{\partial \sigma^b} B_{\mu\nu}$$

Why is there always that Multiplet?

Measure the "B charge" carried by a string by surrounding it with a sphere....

Particle

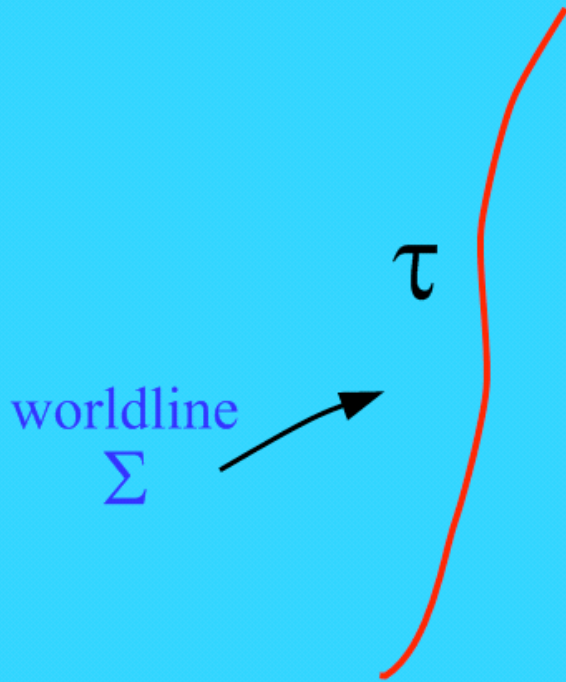

$$\int_{\Sigma} A = \int d\tau \frac{\partial X^{\mu}}{\partial \tau} A_{\mu}$$

String

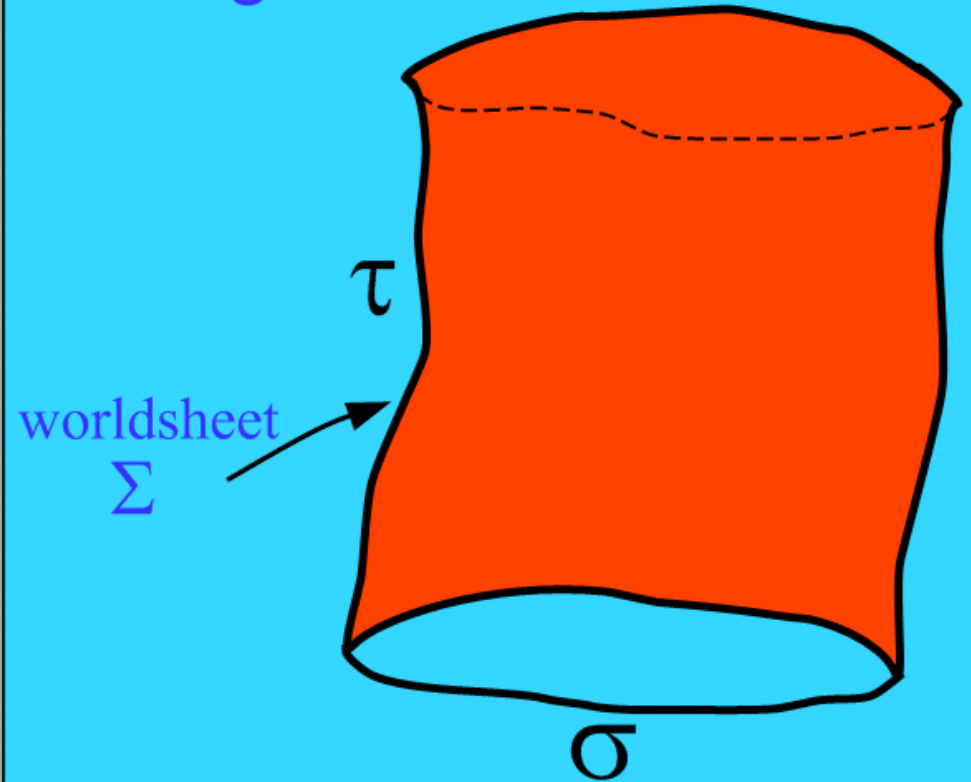

$$\int_{\Sigma} B = \int d^2\sigma \varepsilon^{ab} \frac{\partial X^{\mu}}{\partial \sigma^a} \frac{\partial X^{\nu}}{\partial \sigma^b} B_{\mu\nu}$$

Why is there always that Multiplet?

Measure the "A charge" carried by a particle in $D=4$ by surrounding it with a two-sphere....

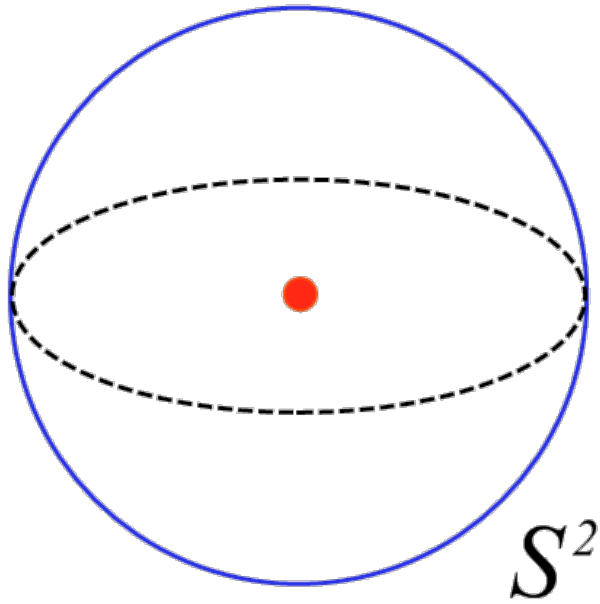

Measure the "B charge" carried by a string in D by surrounding it with a $(D-3)$ -sphere....

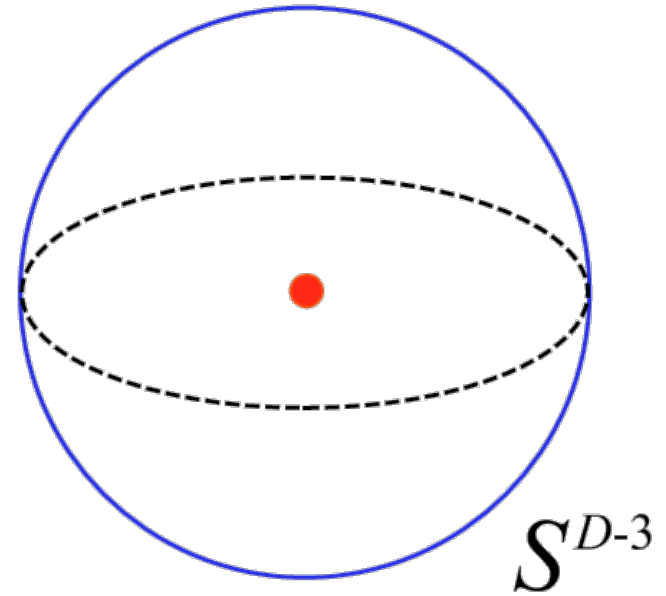

$$F_{\mu\nu} = \partial_\mu A_\nu - \partial_\nu A_\mu \quad F^{(2)} = dA^{(1)}$$
$$\tilde{F}_{\mu\nu} = \frac{1}{2} \epsilon_{\mu\nu}{}^{\rho\sigma} F_{\rho\sigma} \quad \tilde{F}^{(2)} = *F^{(2)}$$

$$\text{total charge} = \int_{S^2} \tilde{F}^{(2)}$$

$$H^{(3)} = dB^{(2)}$$
$$\tilde{H}^{(D-3)} = *H^{(3)}$$

$$\text{total charge} = \int_{S^{D-3}} \tilde{H}^{(D-3)}$$

Supersymmetric Strings

So you see that the string is the fundamental source or “charge carrier” of the B -field.

Type IIA : C_μ , $C_{\mu\nu\kappa}$, $C_{\mu\nu\kappa\sigma\rho}$, $C_{\mu\nu\kappa\sigma\rho\lambda\gamma}$

Type IIB : C , $C_{\mu\nu}$, $C_{\mu\nu\kappa\sigma}$, $C_{\mu\nu\kappa\sigma\rho\lambda\gamma}$, $C_{\mu\nu\kappa\sigma\rho\lambda\gamma\tau}$

Type I : $C_{\mu\nu}$, $C_{\mu\nu\kappa\sigma\rho\lambda\gamma}$

Type I, Type IIA and Type IIB all have R-R sector, where higher rank forms arise....

Might there be fundamental charge carriers for them too?

Supersymmetric Strings

Type IIA : C_μ , $C_{\mu\nu\kappa}$, $C_{\mu\nu\kappa\sigma\rho}$, $C_{\mu\nu\kappa\sigma\rho\lambda\gamma}$

Type IIB : C , $C_{\mu\nu}$, $C_{\mu\nu\kappa\sigma}$, $C_{\mu\nu\kappa\sigma\rho\lambda\gamma}$, $C_{\mu\nu\kappa\sigma\rho\lambda\gamma\tau}$

Type I : $C_{\mu\nu}$, $C_{\mu\nu\kappa\sigma\rho\lambda\gamma}$

$$G^{(p+2)} = dC^{(p+1)}$$

$$\tilde{G}^{(8-p)} = *G^{(p+2)}$$

$$\text{total charge} = \int_{S^{8-p}} \tilde{G}^{(8-p)}$$

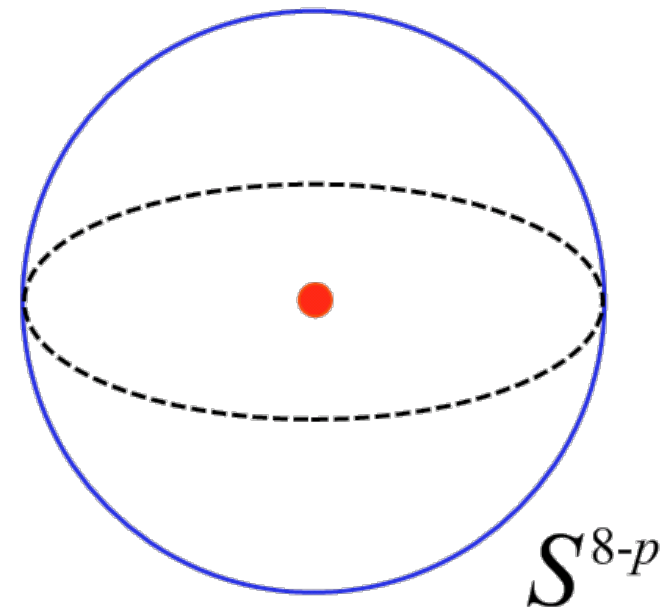

Branes as Sources

Sources can be constructed in two different ways (I)

p -brane "Solitons" (Supergravity Solution)

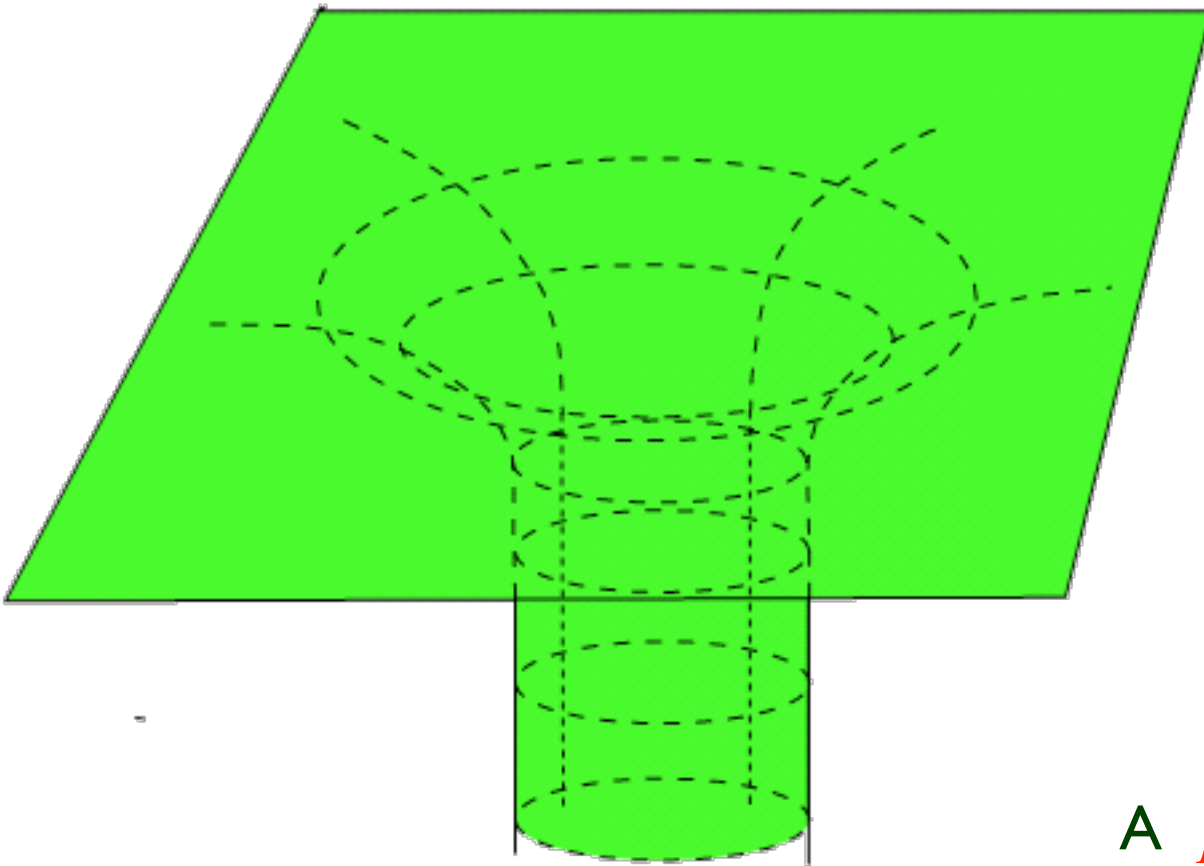

A p -brane is extended in p spatial directions, and so is a localised lump in $9-p$ directions

Branes as Sources

Sources can be constructed in two different ways (I)

p -brane "Solitons" (Supergravity Solution)

These solutions are like generalised black holes, but with degenerate (zero-sized) horizons...

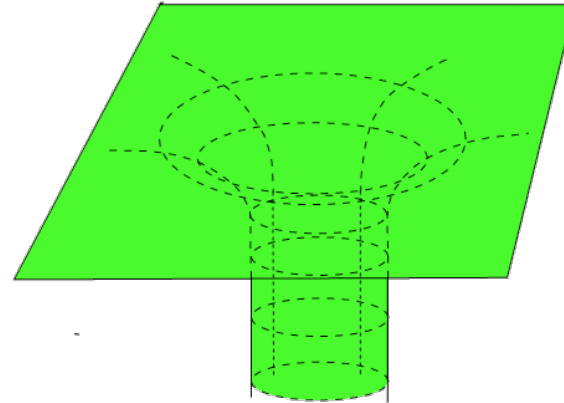

$$ds^2 = H_p^{-\frac{1}{2}} \left(-dt^2 + dx_1^2 + \cdots + ds_p^2 \right) + H_p^{\frac{1}{2}} \left(dr^2 + r^2 d\Omega_{8-p}^2 \right)$$

$$C^{(p+1)} = \left(H_p^{-1} - 1 \right) dt \wedge dx_1 \wedge \cdots \wedge dx_p$$

$$e^{2\Phi} = H_p^{\frac{3-p}{2}}, \quad H_p \equiv 1 + \frac{r_p^{7-p}}{r^{7-p}} \quad r_p^{7-p} \simeq g_s N \alpha'^{\frac{7-p}{2}} .$$

Wait! Don't get nervous....

Reissner-Nordstrom

Thinking about black hole solutions sometimes helps...

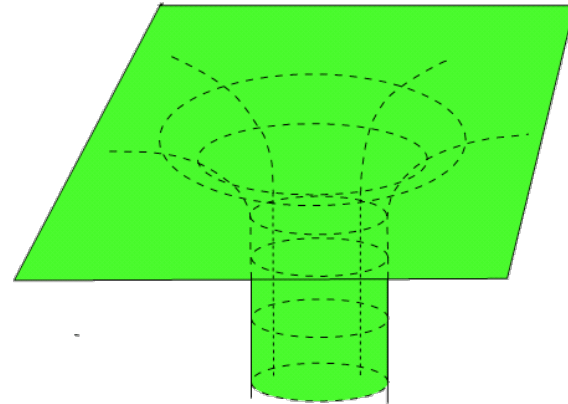

$$ds^2 = - \left(1 - \frac{2M}{R} + \frac{Q^2}{R^2} \right) dt^2 + \left(1 - \frac{2M}{R} + \frac{Q^2}{R^2} \right)^{-1} dR^2 + R^2 d\Omega_2^2$$

$$A = \frac{Q}{R} dt .$$

$$\text{horizons at: } R_{\pm} = M \pm \sqrt{M^2 - Q^2}$$

Reissner-Nordstrom

$$ds^2 = - \left(1 - \frac{2M}{R} + \frac{Q^2}{R^2} \right) dt^2 + \left(1 - \frac{2M}{R} + \frac{Q^2}{R^2} \right)^{-1} dR^2 + R^2 d\Omega_2^2 .$$

$$A = \frac{Q}{R} dt .$$

horizons at: $R_{\pm} = M \pm \sqrt{M^2 - Q^2}$

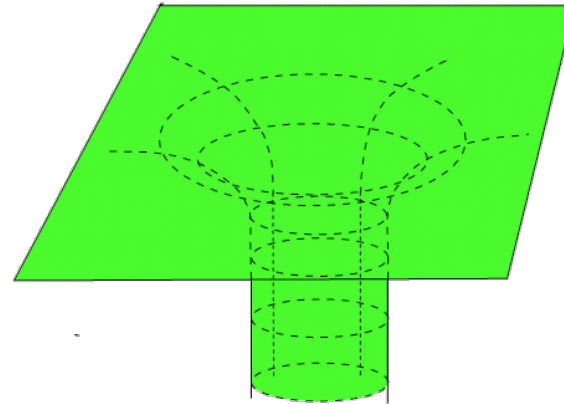

Extremal when $M = Q$; change variables to $r = R - Q$:

$$ds^2 = -H^{-2} dt^2 + H^2 [dr^2 + r^2 d\Omega_2^2] ; \quad H = 1 + \frac{Q}{r} .$$

$$A_t = - (H^{-1} - 1) dt .$$

degenerate horizon at: $r = 0$.

Branes as Sources

This is similar to what we have here:

p -brane "Solitons" (Supergravity Solution)

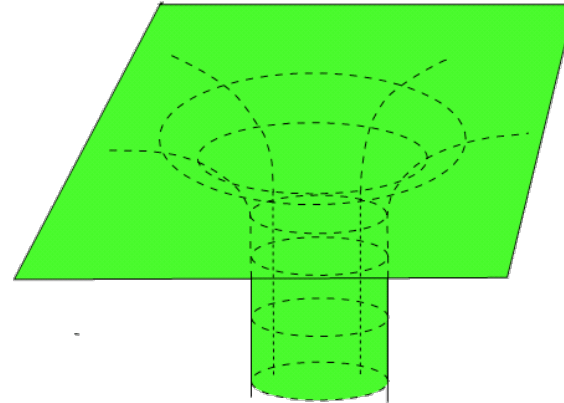

$$ds^2 = H_p^{-\frac{1}{2}} \left(-dt^2 + dx_1^2 + \cdots + dx_p^2 \right) + H_p^{\frac{1}{2}} \left(dr^2 + r^2 d\Omega_{8-p}^2 \right)$$

$$C^{(p+1)} = \left(H_p^{-1} - 1 \right) dt \wedge dx_1 \wedge \cdots \wedge dx_p$$

$$e^{2\Phi} = H_p^{\frac{3-p}{2}}, \quad H_p \equiv 1 + \frac{r_p^{7-p}}{r^{7-p}} \quad r_p^{7-p} \simeq g_s N \alpha'^{\frac{7-p}{2}} .$$

Must be careful...these solutions are *nearly* all singular at $r = 0$. Should draw a more refined picture.

Branes as Sources

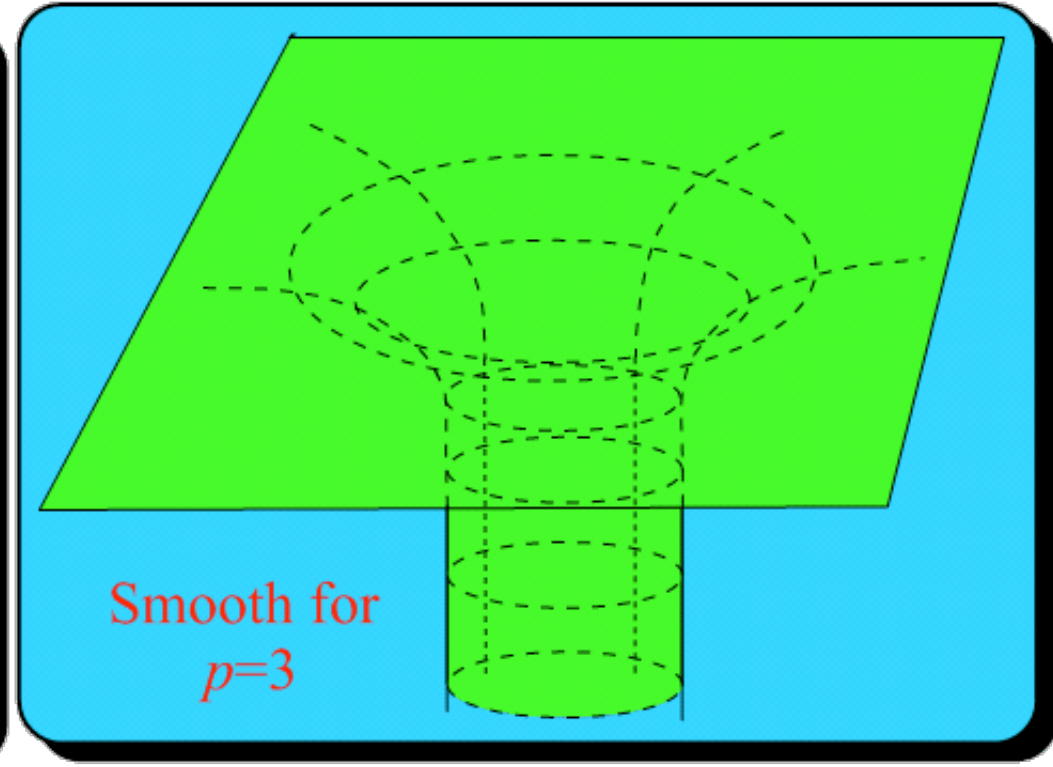
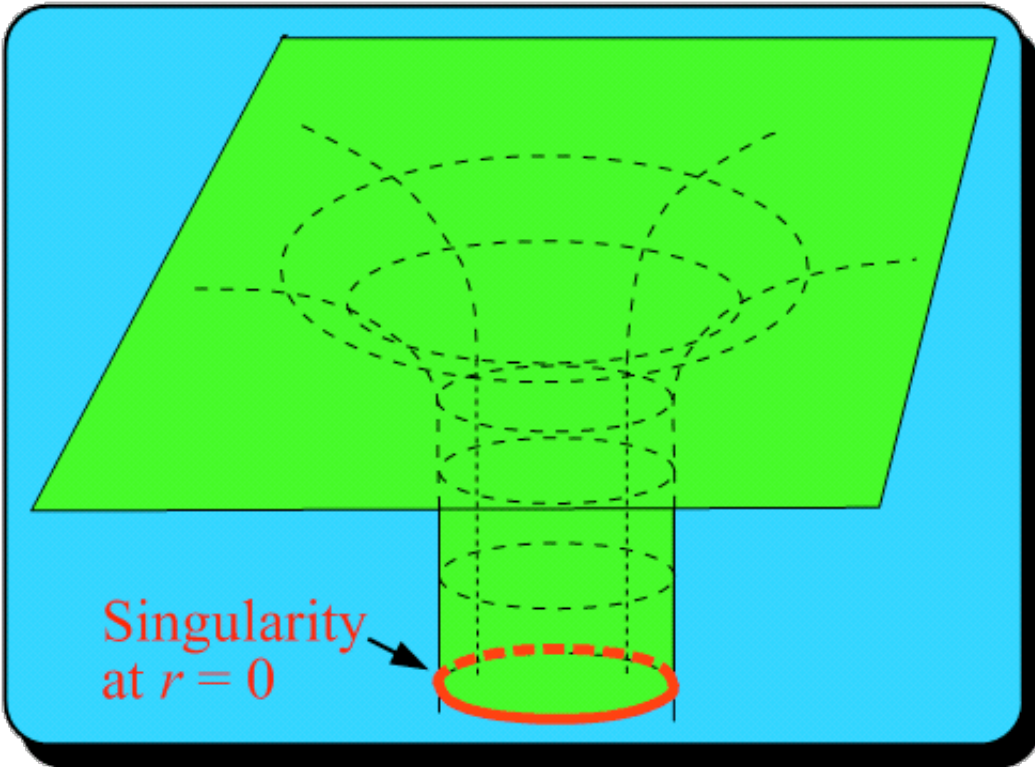

This will be very important later....

Branes as Sources

Sources can be constructed in two different ways (II)

Dp -brane "Solitons" (Superstring boundary conditions)

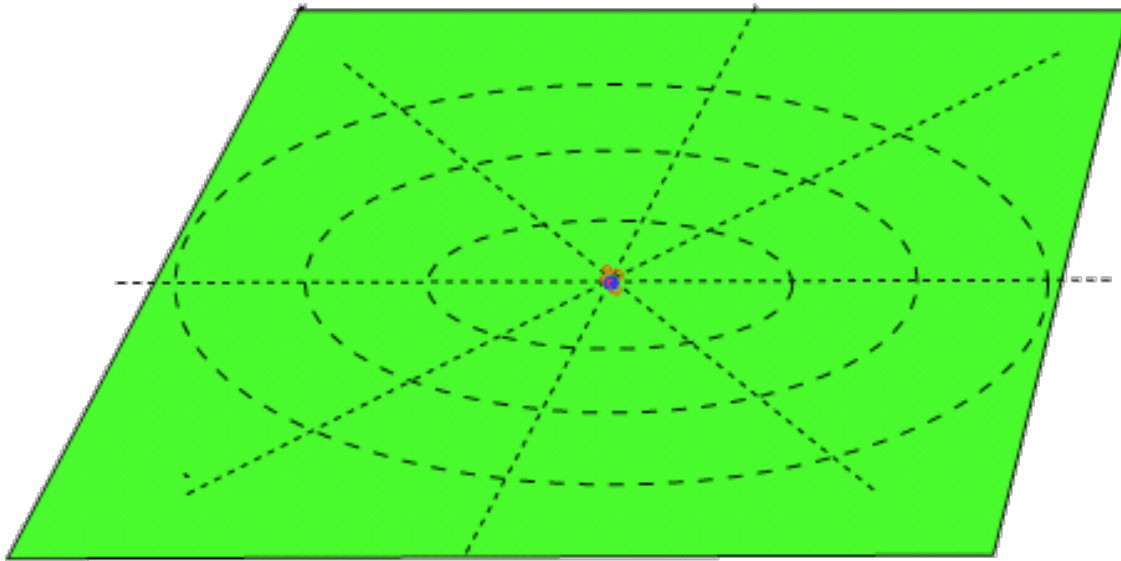

A Dp -brane is extended in p spatial directions, and so is a localised lump in $9-p$ directions

Branes as Sources

Sources can be constructed in two different ways (II)

Dp -brane "Solitons" (Superstring boundary conditions)

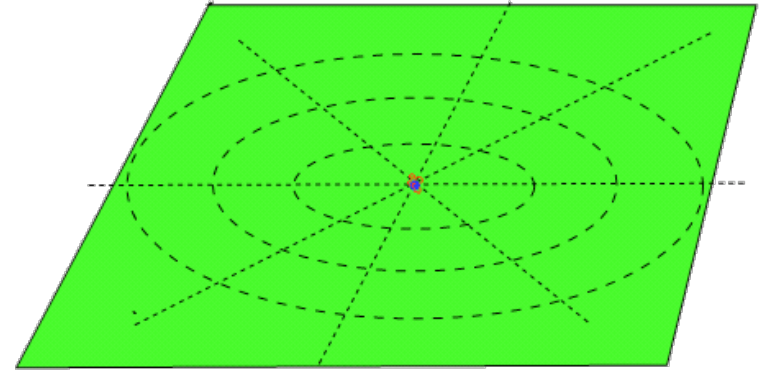
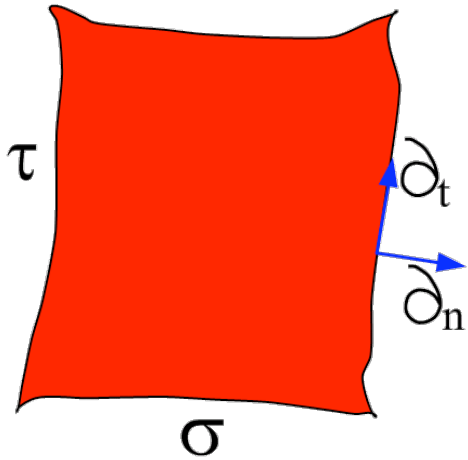

$$X^M(\sigma, \tau) ; \quad M = 0, \dots, D - 1$$

Dirichlet Condition:

$$\partial_t X^m = 0 ; \quad m = p + 1, \dots, D - 1$$

Neumann Condition:

$$\partial_n X^\mu = 0 ; \quad \mu = 0, \dots, p$$

Branes as Sources

Sources can be constructed in two different ways (II)

Dp -brane "Solitons" (Superstring boundary conditions)

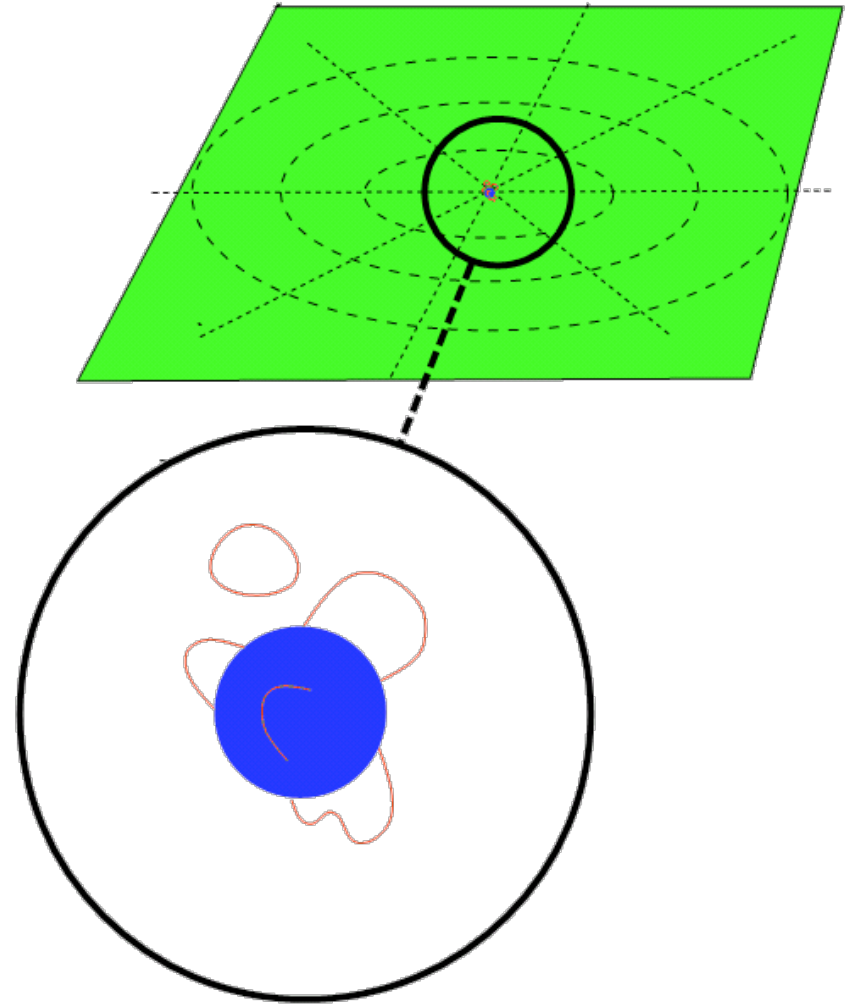

Better picture...

Branes as Sources

Single:

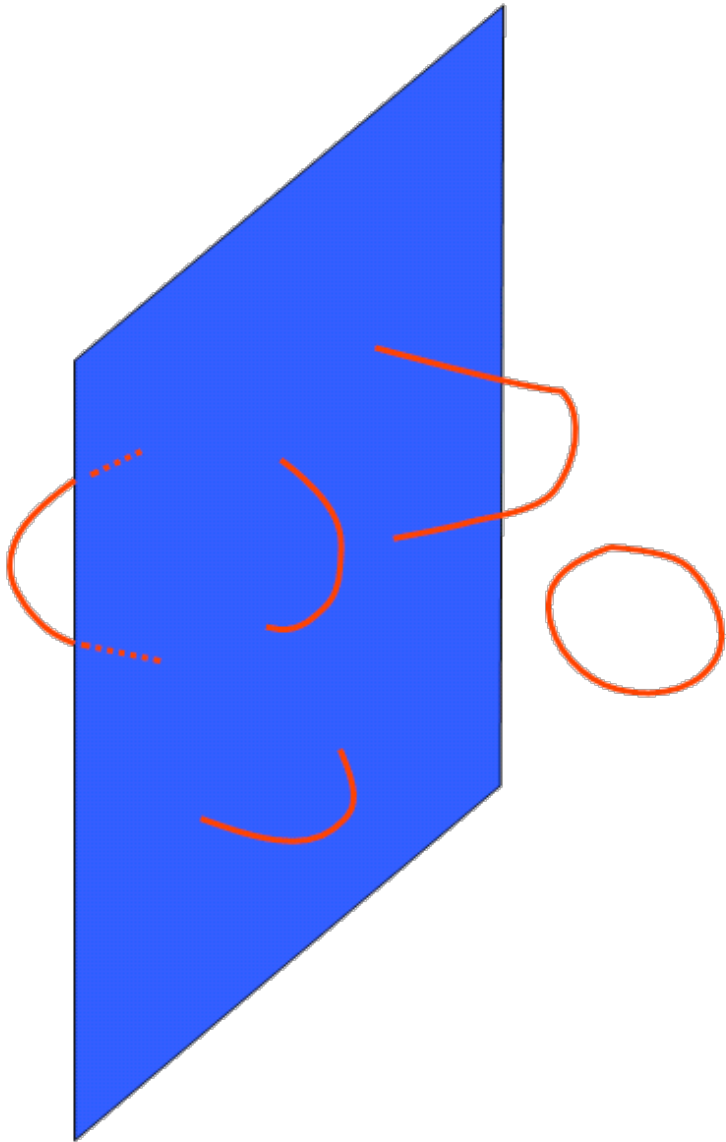

Multiple:

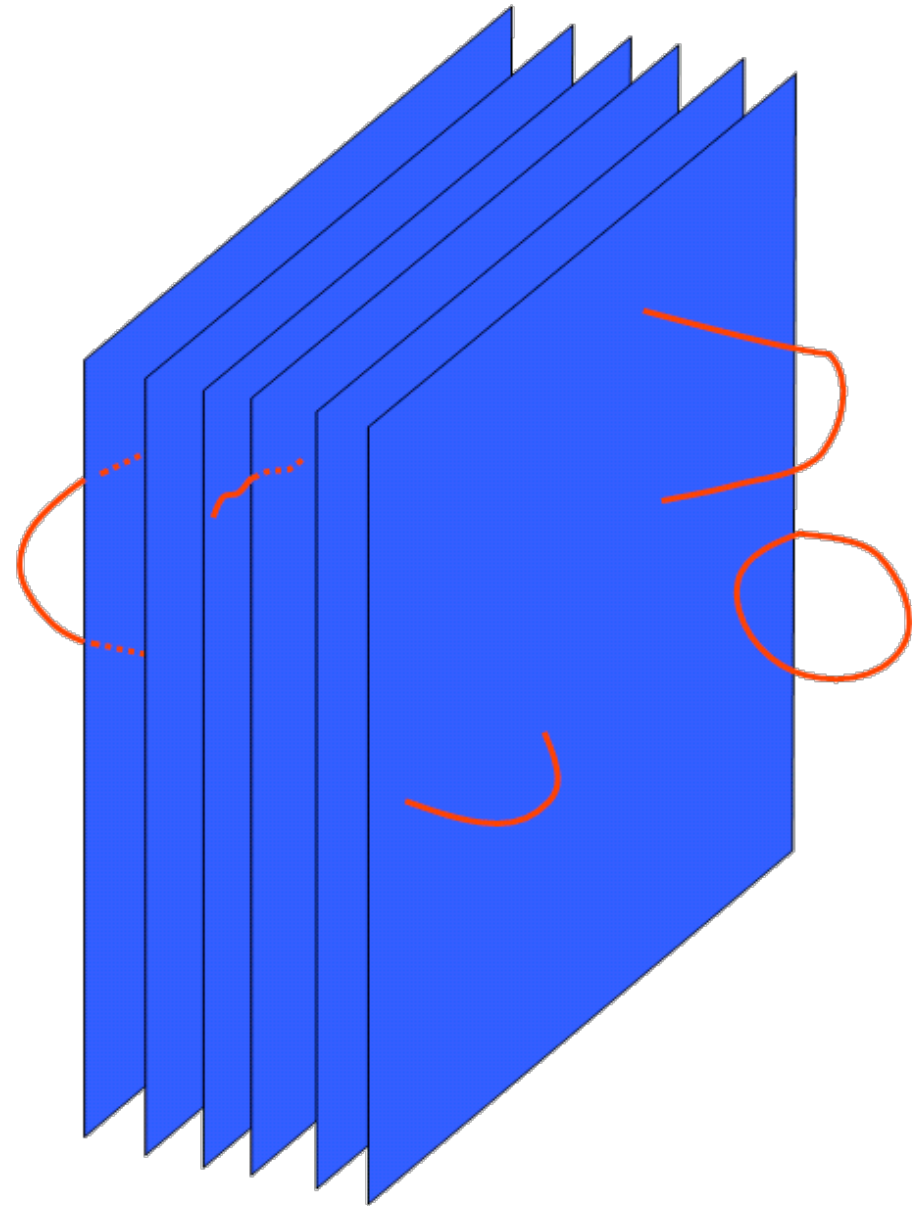

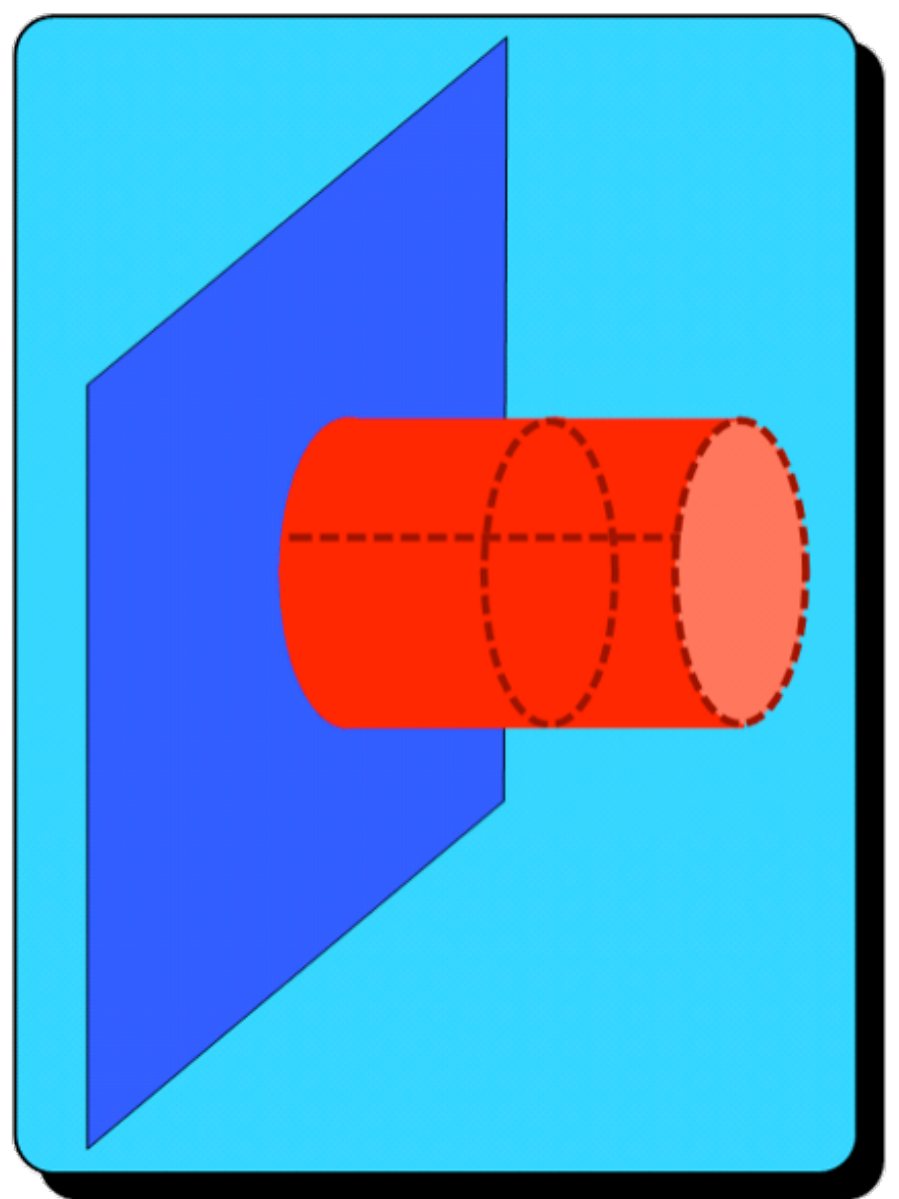
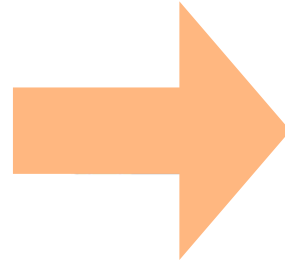
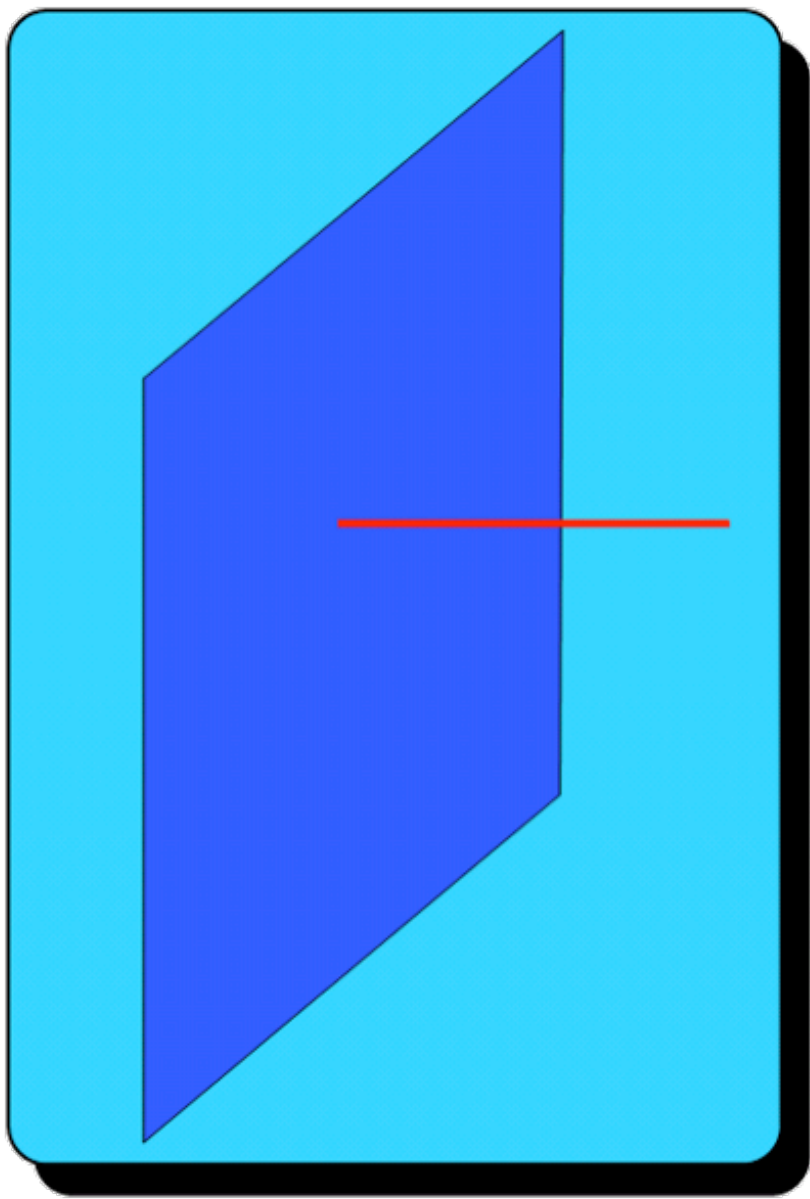

Within the open/closed description, one can describe the D-branes' natural sourcing of closed string fields including R-R sector!

NS-NS: $\longrightarrow G_{\mu\nu}, \Phi$

R-R: $\longrightarrow C_{\mu_0\mu_1\cdots\mu_p}$

D-Branes as Sources

So we have odd D-branes in Types IIB and I and even in Type IIA....

$$G_{\mu\nu}, B_{\mu\nu}, \Phi$$

IIA or IIB string itself couples to B

Type IIA : $C_\mu, C_{\mu\nu\kappa}, C_{\mu\nu\kappa\sigma\rho}, C_{\mu\nu\kappa\sigma\rho\lambda\gamma}$ **D0, D2, D4, D6**

Type IIB : $C, C_{\mu\nu}, C_{\mu\nu\kappa\sigma}, C_{\mu\nu\kappa\sigma\rho\lambda\gamma}, C_{\mu\nu\kappa\sigma\rho\lambda\gamma\tau}$ **D(-1), D1, D3, D5, D7**

Type I : $C_{\mu\nu}, C_{\mu\nu\kappa\sigma\rho\lambda\gamma}$ **D1, D5**

$$G_{\mu\nu} \quad \Phi \quad A_\mu$$

(ends of string couple to the SO(32) gauge field)

D-Branes as Sources

What is the relation between the two descriptions of branes?

In the supergravity solutions, the key parameter controlling the scale of curvature is the product: $g_s N$

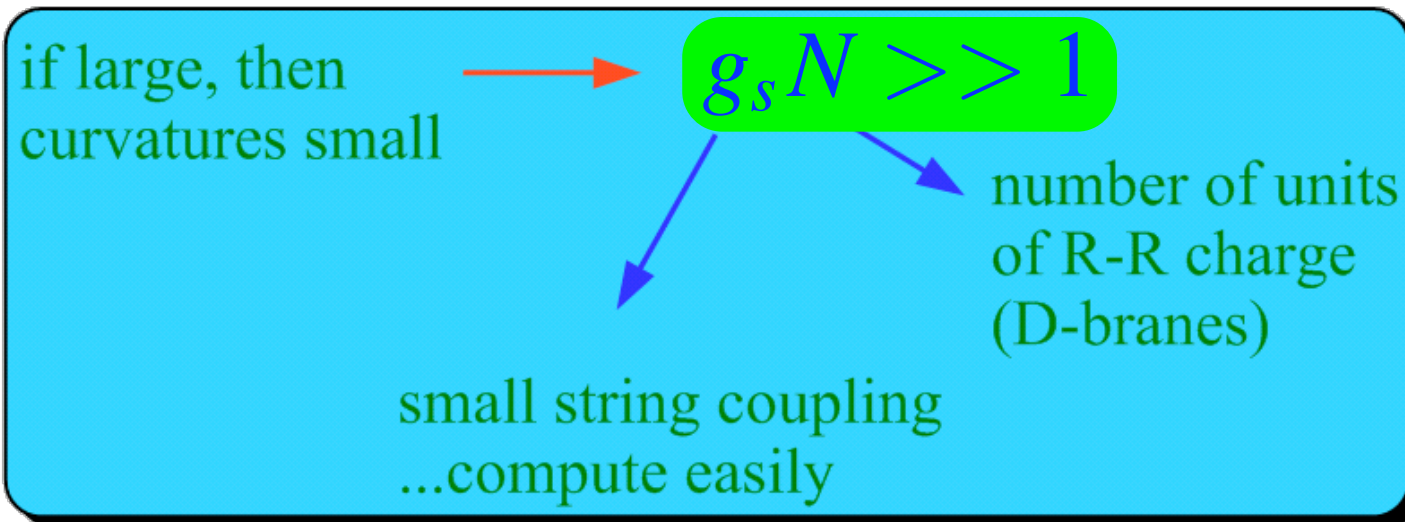

if small, then gauge theory perturbative
..compute easily

$g_s N \ll 1$

These two regimes are complementary...what do they mean for the geometry?

D-Branes as Sources

The limit of small $g_s N$

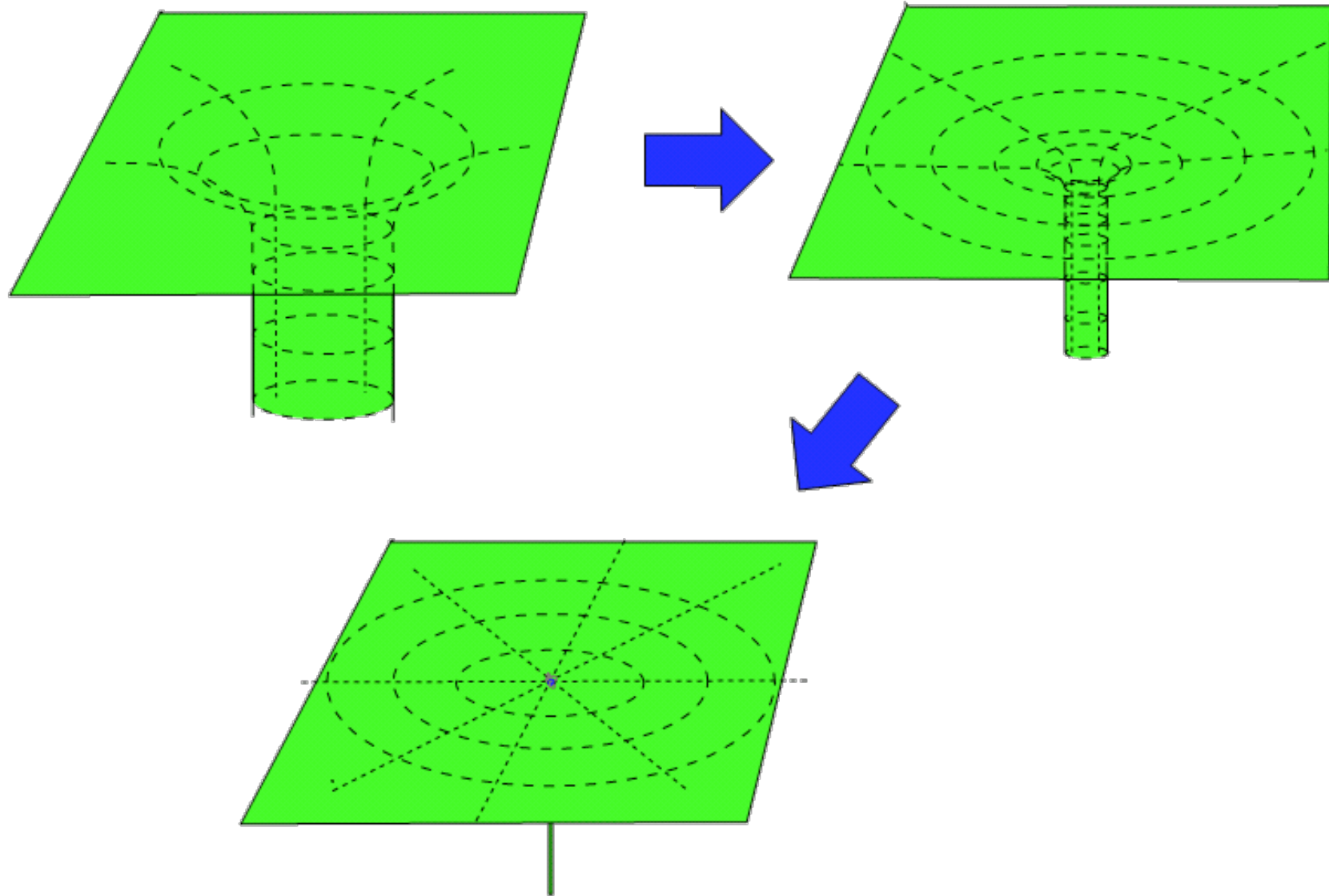

Eventually, supergravity (closed string) analysis breaks down....

.... but gauge theory (open string) description is valid

D-Branes as Sources

The limit of small $g_s N$

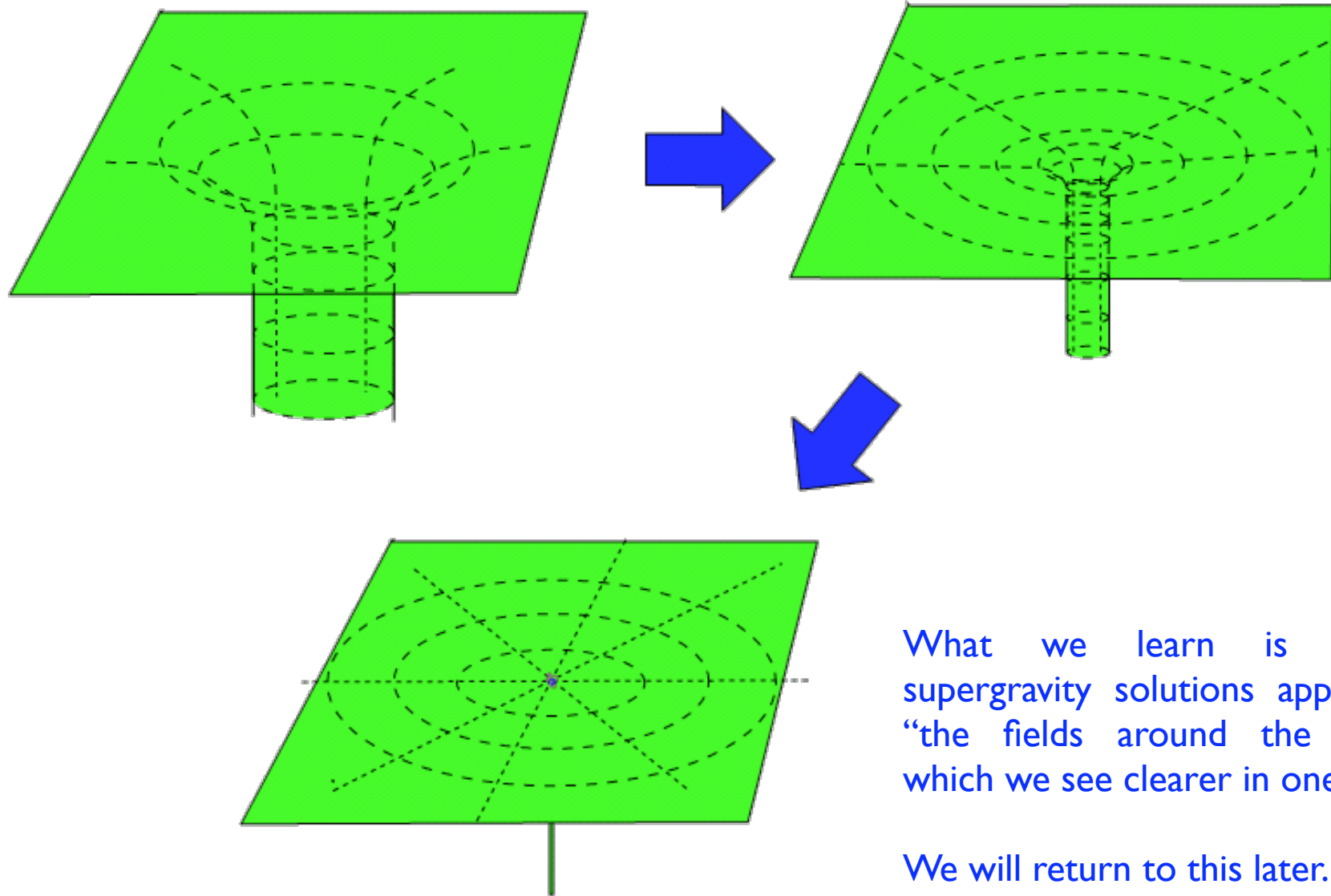

What we learn is that the supergravity solutions appear to be “the fields around the D-brane”, which we see clearer in one limit.

We will return to this later.

Eventually, supergravity (closed string) analysis breaks down....

.... but gauge theory (open string) description is valid

D-Branes as Sources

Could the gravity solutions
have been made of anything
else?

No. The D-branes are the most basic sources with those charges.

Here's how to see this:

Quantum Consistency

Dirac Quantisation

The presence of objects carrying magnetic charges of a field when there are already electric charges present is highly constrained by the rules of quantum mechanics....

$$\begin{array}{ccc}
 F_{\mu\nu} & \longleftrightarrow & \tilde{F}_{\mu\nu} \\
 \text{electron} & \longleftrightarrow & \text{monopole} \\
 \text{monopole} & \longleftrightarrow & \text{electron}
 \end{array}$$

Constructing the monopole produces an infinite "Dirac String"... *The electron potentially sees this string as a phase change of the wavefunction upon circulation...*

$$e^{i e g / \hbar}$$

For this "Dirac String" to be absent in the theory, we must therefore have....

$$\frac{e g}{\hbar} = 2\pi n \longrightarrow e = \frac{2\pi n \hbar}{g}$$

Therefore the electric and magnetic charges are quantized in terms of each other!

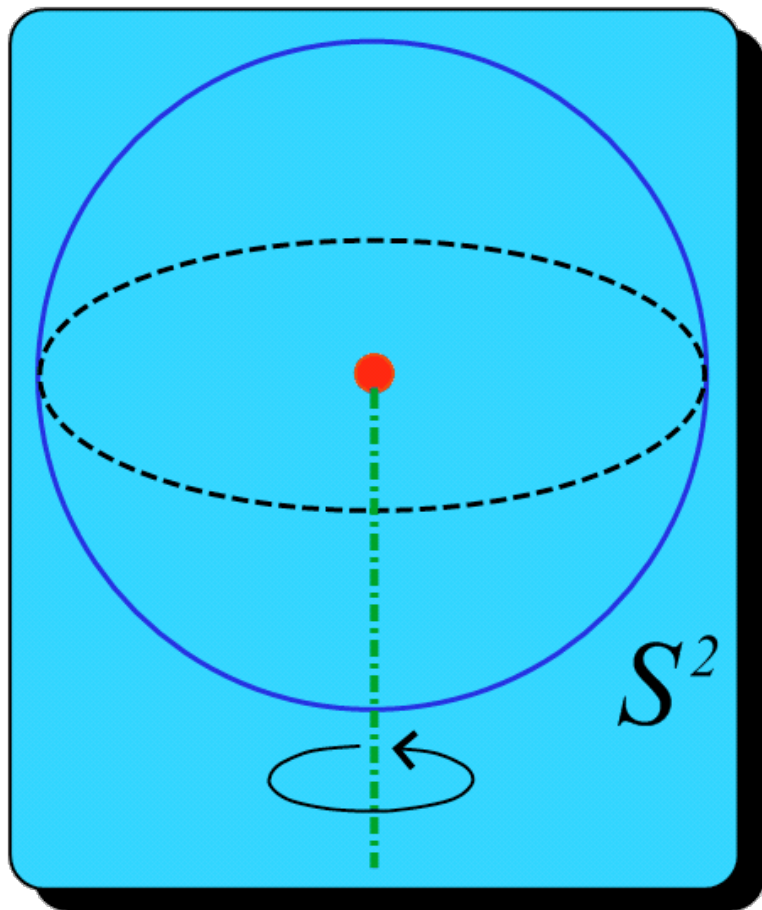

Quantum Consistency

Dirac Quantisation

The same is true for branes... We have both electric and magnetic charge carriers under any given R-R sector field... What do the rules of quantum mechanics require of us...?

$$G^{(p+2)} = dC^{(p+1)} \longleftrightarrow G^{(8-p)} = dC^{(7-p)}$$

$$Dp\text{-brane} \longleftrightarrow D(6-p)\text{-brane}$$

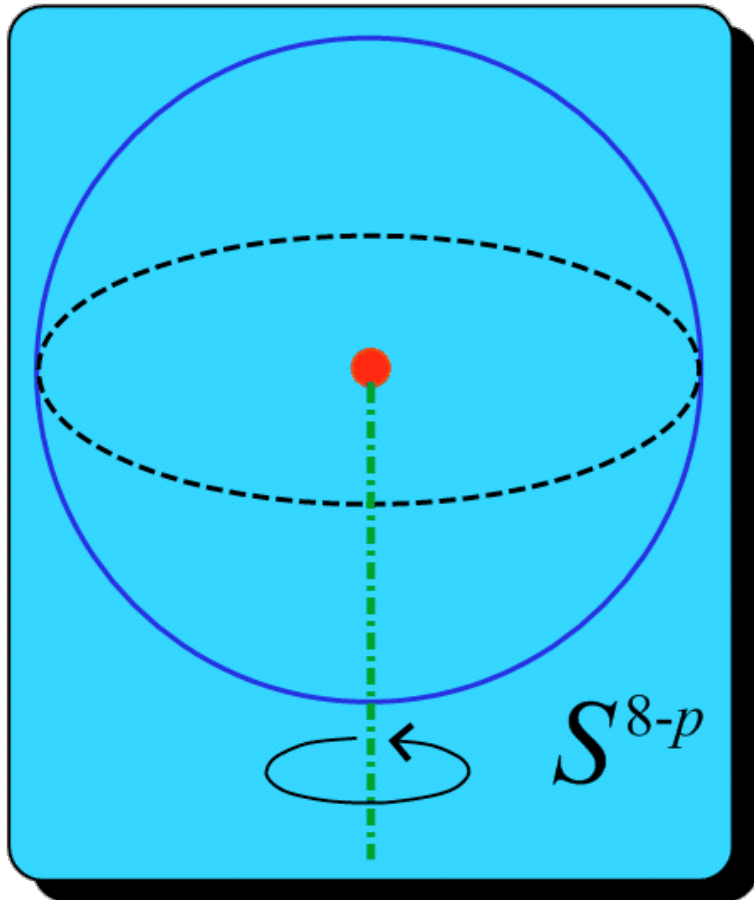

Constructing the monopole produces an infinite "Dirac Sheet"... *The Dp -brane potentially sees this string as a phase change of the wavefunction upon circulation...*

$$e^{i\mu_p\mu_{6-p}2\kappa_0^2}$$

For this "Dirac Sheet" to be absent in the theory, we must therefore have....

$$\mu_p\mu_{6-p}2\kappa_0^2 = 2\pi n \longrightarrow \mu_p = \frac{2\pi n}{\mu_{6-p}2\kappa_0^2}$$

Therefore the electric and magnetic charges are quantized in terms of each other, constraining the theory!

Quantum Consistency

Dirac Quantisation

Compute the charges μ_p for the D-branes,

$$\mu_p = (2\pi)^{-p} \alpha'^{-\frac{(p+1)}{2}}$$

R-R charge

$$\tau_p = g_s^{-1} \mu_p$$

tension

$$2\kappa^2 \equiv 2\kappa_0^2 g_s^2 = 16\pi G_N = (2\pi)^7 \alpha'^4 g_s^2$$

and find that they satisfy the constraint with $n=1$!!

In other words, D-branes carry the smallest possible charges of the R-R sector.

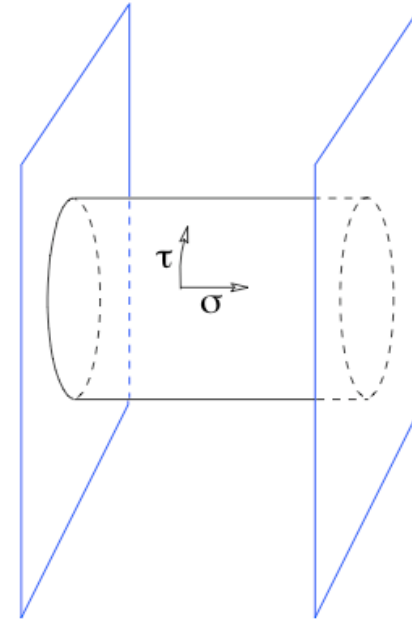

D-Branes as BPS States

Mass Equals Charge

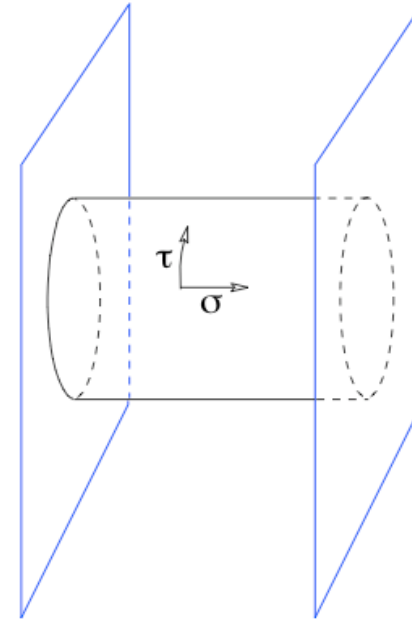

$$\mu_p = (2\pi)^{-p} \alpha'^{-\frac{(p+1)}{2}}$$

R-R charge

$$\tau_p = g_s^{-1} \mu_p$$

tension

D-branes saturate the Bogolmo'nyi-Prasad-Sommerfeld bound: $\tau_p \geq g_s^{-1} \mu_p$

BPS states are the lightest states for that given charge.

They cannot decay.

They do not interact with each other (attraction balances repulsion)

The perturbative computation of their mass/charge is exact.

This will be vital for taking us beyond perturbation theory.