

Lambda User Controlled Infrastructure for European Research (LUCIFER)

Manos Varvarigos

Research Academic Computer Technology Institute
(RACTI)

LUCIFER overview

- 30 months IP IST project, to begin May 2006

Project Vision and Mission

- Develop advanced middleware solutions and underlying management and network control plane technologies
- On demand end-to-end services across multiple domains
- In LUCIFER the underlying network will be treated as first class Grid resource.
- LUCIFER will demonstrate solutions and functionalities across a test-bed involving NRENs, GÉANT2, and Cross Border Dark Fibre

Partners

1. PSNC, Poland	12. SARA, Netherlands
2. ADVA Optical Networking, Germany	13. SURFnet, Netherlands
3. CESNET Czech Republic	14. Univ. Bonn, Germany
4. Nextworks, Italy	15. University van Amsterdam, Netherlands
5. Fraunhofer, Germany	16. University of Essex, UK
6. i2CAT, Spain	17. Universiy of Wales, UK
7. HFZJ, Germany	18. NORTEL, USA
8. HITACHI Europe, France	19. MCNC, USA
9. IBBT, Belgium	20. Center for Computation & Technology at LSU, USA
10. RACTI, Greece	21. Communications Research Centre Canada, Canada
11. RESIT, Greece	

Objective 1

- Demonstrate on demand service delivery across multi-domain/multi-vendor research network test-beds on a European and Worldwide scale.
- The testbed will include:
 - EU NRENs: SURFnet, CESNET, PIONIER
 - National test-beds (VIOLA, OptiCAT, UKLight)
 - GN2, and Cross Border Dark Fibre connectivity infrastructure
 - GMPLS, UCLP, DRAC and ARGON control and management planes
 - Multi-vendor equipment environment (ADVA, HITACHI, NORTEL, equipment in participating NRENs)

The LUCIFER Test-bed

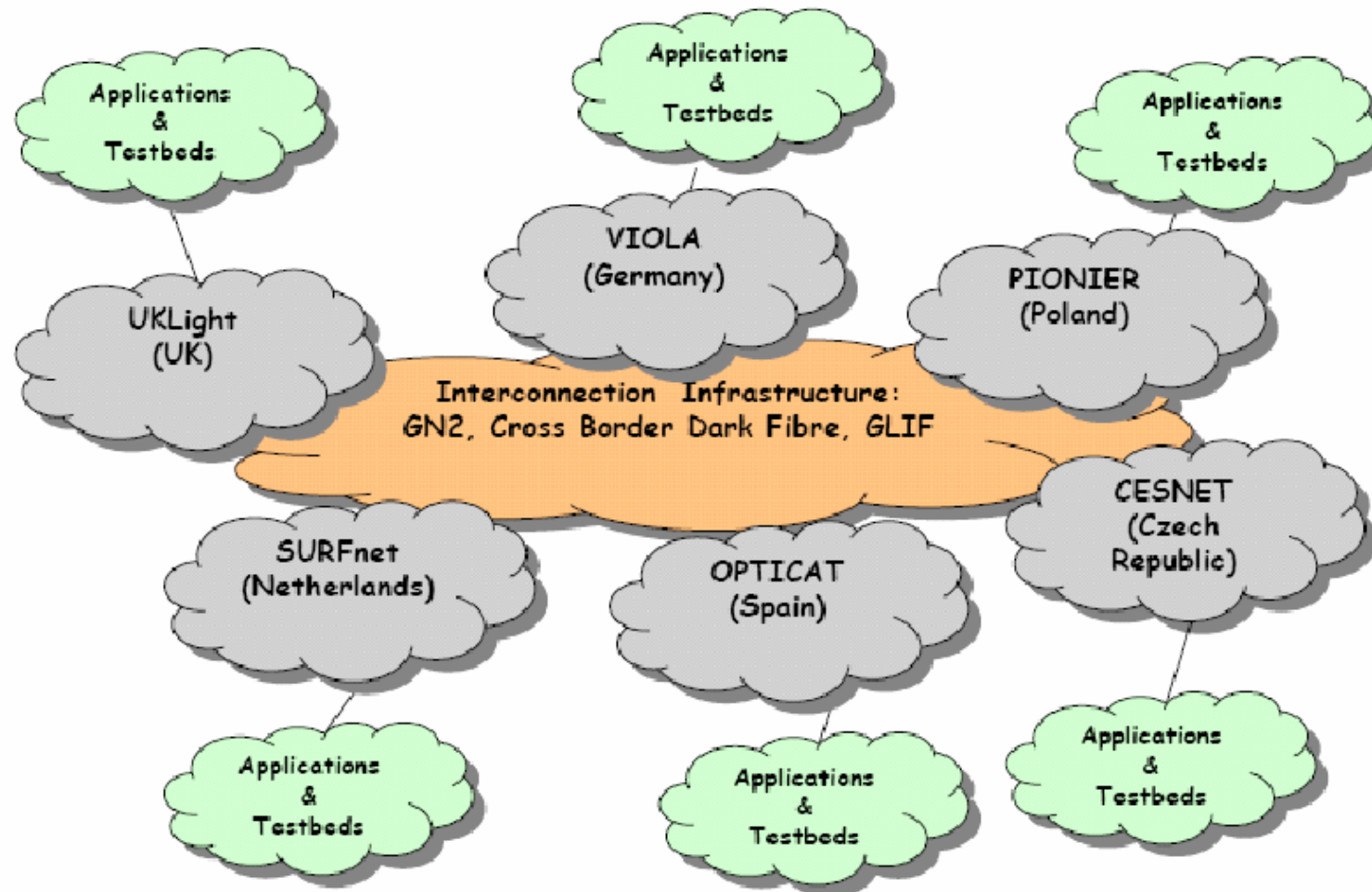

Objective 2

- Development and integration between application middleware and transport networks, based on three planes:
- **Service plane:**
 - Middleware extensions and APIs to expose network and Grid resources and make reservations of those resources, allowing both network resource owners and applications to have a stake in the decision to allocate specific network resources
- **Network Resource Provisioning plane:**
 - Adaptation of existing Network Resource Provisioning Systems (NRPS) to support the framework of the project
 - Implementation of interfaces between different NRPS to allow multi-domain interoperability with LUCIFER's resource reservation system
- **Control plane:**
 - Enhancements of the GMPLS Control Plane (G²MPLS) to provide optical network resources as first-class Grid resource
 - Interworking of GMPLS-controlled network domains with NRPS-based domains (interoperability between G²MPLS and UCLP, DRAC and ARGON)

Objective 3

- Study resource management and job scheduling algorithms incorporating QoS, network-awareness, constraint based routing, and in advance/timed reservation techniques
- Develop a simulation environment, supporting the LUCIFER network scenario
- Disseminate the project experience and outcomes, toolkits and middleware to EU NRENs and their users, such as Supercomputing centres

Joint in Advance/Timed Reservations of Computation and Communication Resources

Need: without reservations there can be no QoS guarantees

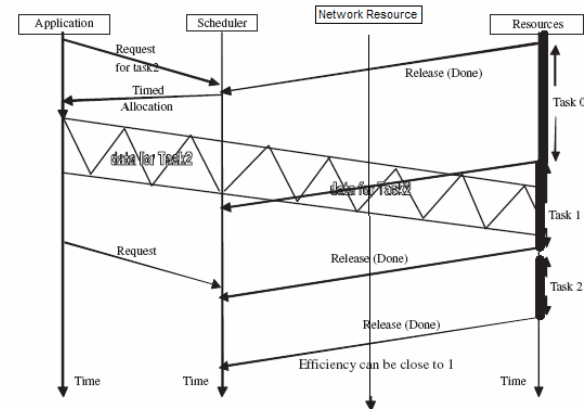

Key idea: Computation and communication resources are reserved only for the time interval they are actually used, and are available to be used by other users for the remaining time

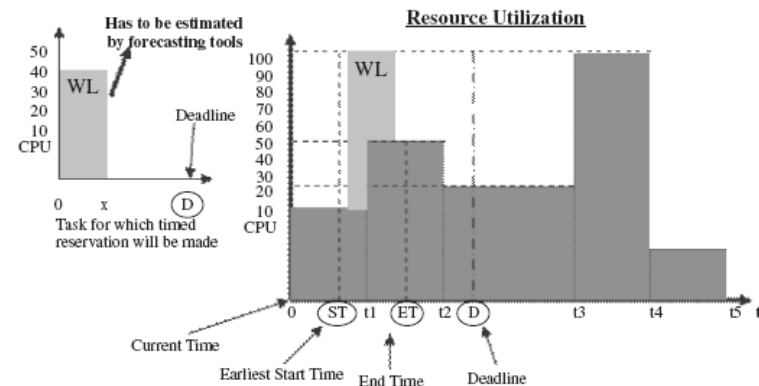

Burst Routing Problem

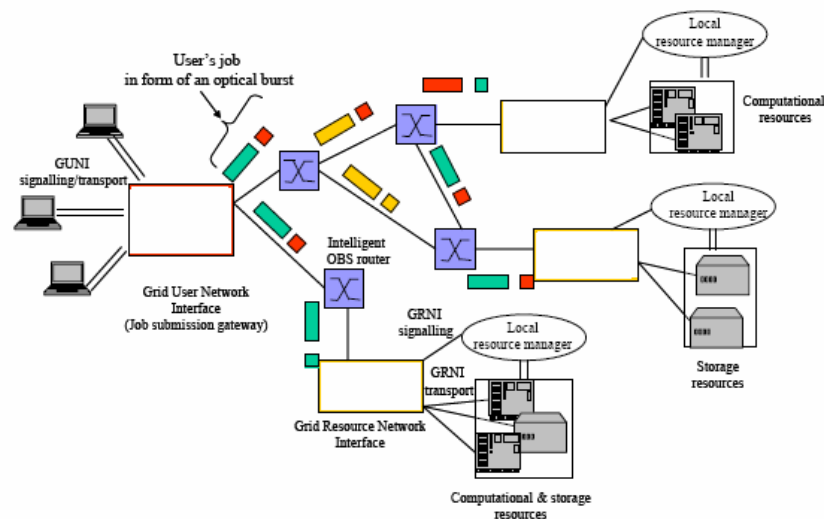
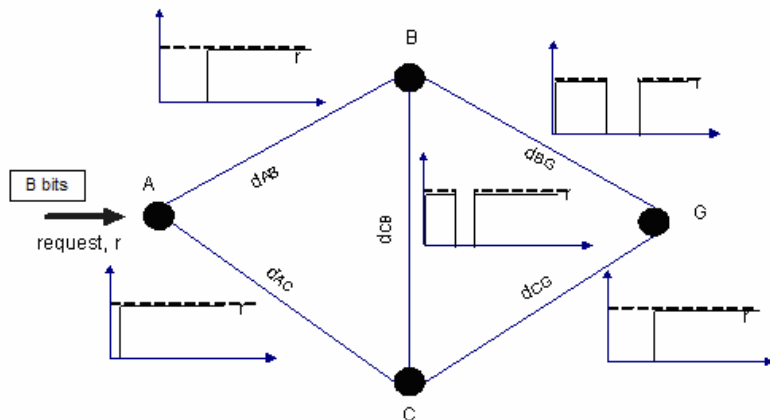

Find the best path to transfer the burst in minimum time, taking into account impairment constraints

Our Approach: Multicast routing

$$\begin{aligned} \hat{C}_{ABC} &= \hat{C}_{AB} \oplus \hat{C}_{BC} = \\ &= \hat{C}_{AB} \& \text{LSH}_{d_{AB}}(\hat{C}_{BC}(A)) = \\ &= \hat{C}_{AB} \& \text{LSH}_{2d_{AB}}(\hat{C}_{BC}) \end{aligned}$$

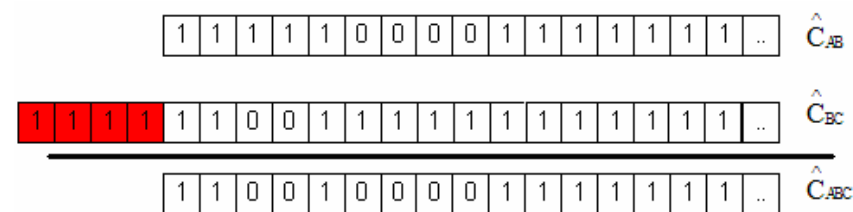

QoS Scheduling

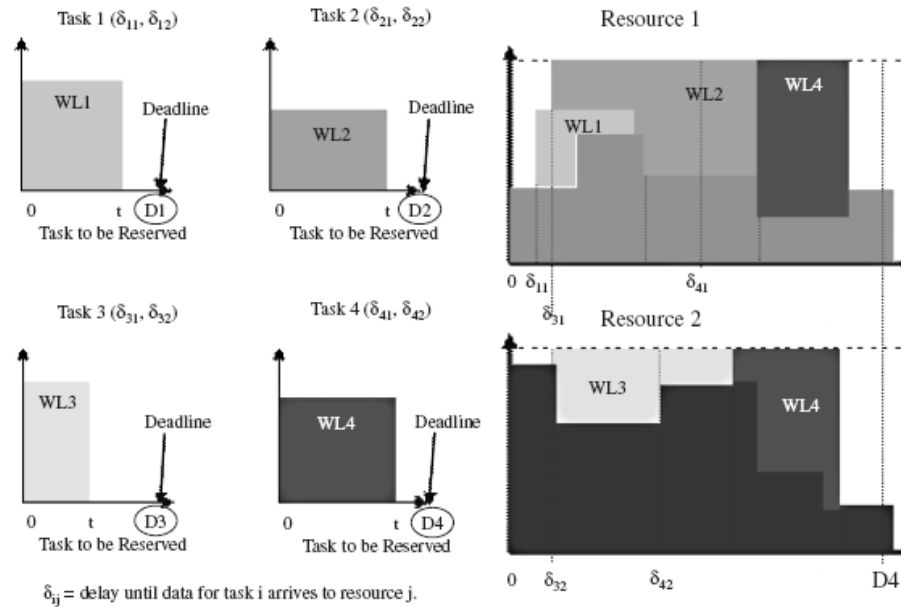

QoS for us means:

- Within deadline
- With max-min fairness

Also need simulation

Inter-domain issues and solutions

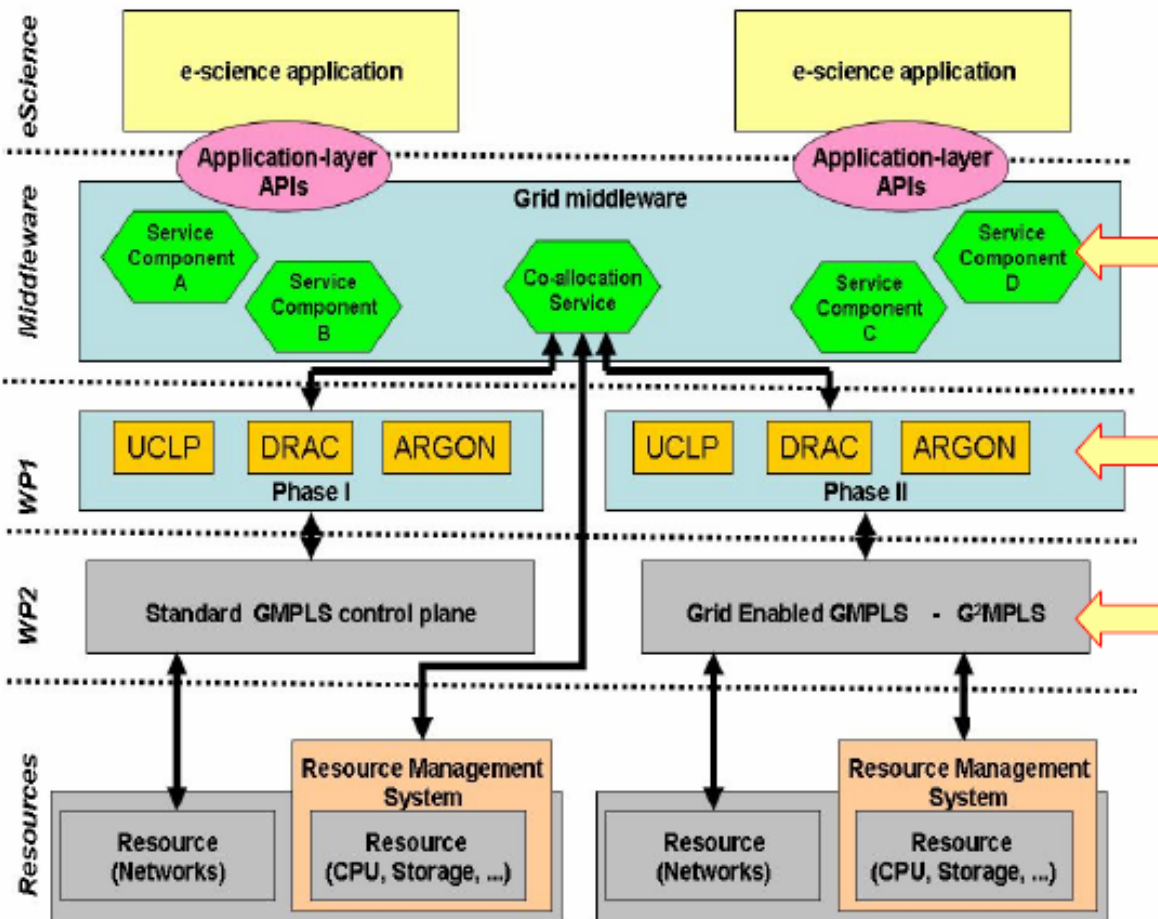

The different domains of the LUCIFER test-bed will have:

- Grid middleware
 - UNICORE as a reference point
 - AAA policies
- three types of NRPS:
 - UCLP
 - DRAC
 - ARGON
- two "flavours" of GMPLS
 - standard (*Ph. 1*)
 - Grid-enabled (*Ph. 2*)